

**price**  
*list*

**MIDJ**<sup>®</sup>





**price**  
*list*

**MIDJ**<sup>®</sup>

# INDEX

## **Chairs**

|                       |     |
|-----------------------|-----|
| Amelie . . . . .      | 18  |
| Apelle . . . . .      | 22  |
| Area . . . . .        | 26  |
| Bolle . . . . .       | 30  |
| Calla . . . . .       | 36  |
| Cover . . . . .       | 58  |
| Dalia . . . . .       | 63  |
| Danny . . . . .       | 77  |
| Guapa . . . . .       | 79  |
| Joe . . . . .         | 82  |
| Kosmos . . . . .      | 89  |
| Lea . . . . .         | 91  |
| Less . . . . .        | 104 |
| Liù . . . . .         | 106 |
| Maya . . . . .        | 117 |
| Master . . . . .      | 119 |
| Mito . . . . .        | 121 |
| Montera . . . . .     | 124 |
| Mys . . . . .         | 127 |
| Nenè . . . . .        | 133 |
| Nuvola . . . . .      | 137 |
| Ola . . . . .         | 144 |
| Oslo . . . . .        | 150 |
| P47 . . . . .         | 152 |
| Pippi . . . . .       | 159 |
| Piuma . . . . .       | 161 |
| Qua-ndo . . . . .     | 164 |
| S1 . . . . .          | 167 |
| Silvy . . . . .       | 169 |
| Slim . . . . .        | 174 |
| Soffio . . . . .      | 177 |
| Sonny . . . . .       | 178 |
| Stack . . . . .       | 187 |
| Star . . . . .        | 190 |
| Strike . . . . .      | 192 |
| Suite . . . . .       | 193 |
| Tosca . . . . .       | 194 |
| Toy . . . . .         | 198 |
| Trampoliere . . . . . | 199 |
| Wrap . . . . .        | 201 |
| Yak . . . . .         | 205 |

## **Tables**

|                      |     |
|----------------------|-----|
| Akashi . . . . .     | 208 |
| Alexander . . . . .  | 210 |
| Alfred . . . . .     | 212 |
| Apollo . . . . .     | 214 |
| Armando . . . . .    | 216 |
| Badù . . . . .       | 218 |
| Blade . . . . .      | 224 |
| Brioso . . . . .     | 230 |
| Clessidra . . . . .  | 231 |
| Dama . . . . .       | 238 |
| Diamante . . . . .   | 241 |
| Eggen . . . . .      | 246 |
| Foil . . . . .       | 247 |
| Fold . . . . .       | 249 |
| Forest . . . . .     | 251 |
| Gran Sasso . . . . . | 253 |
| Infinity . . . . .   | 254 |
| Lea . . . . .        | 257 |
| Link . . . . .       | 258 |
| Marcopolo . . . . .  | 259 |
| Moonlight . . . . .  | 260 |
| More . . . . .       | 261 |
| Nenè . . . . .       | 267 |
| Nexus . . . . .      | 269 |
| Paul . . . . .       | 271 |
| Pechino . . . . .    | 272 |
| Planum . . . . .     | 274 |
| Plissé . . . . .     | 276 |
| Sesamo . . . . .     | 285 |
| Spike . . . . .      | 288 |
| Woody . . . . .      | 289 |
| Zeus . . . . .       | 293 |

## **Coffee Table**

|                       |     |
|-----------------------|-----|
| Apelle . . . . .      | 296 |
| Bloom . . . . .       | 299 |
| Bolle . . . . .       | 301 |
| Clessidra . . . . .   | 304 |
| Dalia . . . . .       | 307 |
| Drop . . . . .        | 308 |
| Guapa . . . . .       | 311 |
| Hoodi . . . . .       | 312 |
| Joint . . . . .       | 313 |
| Lea . . . . .         | 315 |
| Ola . . . . .         | 317 |
| P47 . . . . .         | 318 |
| Paw . . . . .         | 319 |
| Plissé . . . . .      | 320 |
| Suite . . . . .       | 322 |
| Trampoliere . . . . . | 324 |
| Trip . . . . .        | 325 |

## **Complements**

|                    |     |
|--------------------|-----|
| Apelle . . . . .   | 328 |
| Lea . . . . .      | 330 |
| Apelle . . . . .   | 333 |
| Siena . . . . .    | 335 |
| Suite . . . . .    | 337 |
| Hoodi . . . . .    | 338 |
| Apelle . . . . .   | 340 |
| Guapa . . . . .    | 341 |
| Pippi . . . . .    | 342 |
| Bold. . . . .      | 343 |
| Hoodi . . . . .    | 345 |
| Peek . . . . .     | 346 |
| Spot. . . . .      | 347 |
| Bolle . . . . .    | 348 |
| Charlotte. . . . . | 349 |
| Ghost. . . . .     | 351 |
| Japan. . . . .     | 352 |
| Mug. . . . .       | 355 |
| Suspense. . . . .  | 357 |
| Sunrise . . . . .  | 358 |

## **Bases**

|                       |     |
|-----------------------|-----|
| Break . . . . .       | 360 |
| Clessidra . . . . .   | 361 |
| Composit. . . . .     | 363 |
| Dama . . . . .        | 369 |
| Infinity . . . . .    | 371 |
| Liù . . . . .         | 372 |
| Luna . . . . .        | 373 |
| Ola . . . . .         | 374 |
| Plissé . . . . .      | 375 |
| Smart. . . . .        | 377 |
| Square . . . . .      | 379 |
| Trampoliere . . . . . | 381 |

## **Top**

|                           |     |
|---------------------------|-----|
| Top Glass. . . . .        | 384 |
| Marble Top. . . . .       | 385 |
| Melamine Top . . . . .    | 386 |
| Top MDF . . . . .         | 387 |
| Top HPL. . . . .          | 388 |
| Top sheet metal . . . . . | 389 |
| Top Metal. . . . .        | 390 |

## **Accessories**

|                       |     |
|-----------------------|-----|
| Accessoires . . . . . | 392 |
|-----------------------|-----|

|                               |     |
|-------------------------------|-----|
| <b>Ausführungen</b> . . . . . | 393 |
|-------------------------------|-----|

# Tables index by size

## Fix tables

| Model                   | Tops' materials  | Tops' shape |
|-------------------------|--|-------------|
| <b>cm 60</b>            |  |             |
| Break/3                 | melamine, crystalceramic, HPL, metal                         | ● ■         |
| Break/4                 | glass, melamine, HPL   | ●           |
| Composit/1 45x45 H73    | glass, melamine, HPL   | ● ■         |
| Composit/1 45x45 H107   | glass, melamine, HPL   | ● ■         |
| Composit/2 45x45 H73    | glass, melamine, HPL   | ● ■         |
| Composit/2 45x45 H107   | glass, melamine, HPL   | ● ■         |
| Composit/3 diam 45 H73  | glass, melamine, HPL   | ● ■         |
| Composit/3 diam 45 H107 | glass, melamine, HPL   | ● ■         |
| Composit/3 diam 55 H73  | glass, melamine, HPL   | ●           |
| Composit/3 diam 55 H107 | glass, melamine, HPL   | ●           |
| Infinity diam 44        | melamine, glass, crystalceramic, HPL, metal, fenix, laminate | ●           |
| Liu H73                 | melamine, HPL  | ● ■         |
| Liu H107                | melamine, HPL  | ● ■         |
| Plissé H73              | melamine, laminate, fenix, HPL, metal sheet, metal           | ●           |
| Plissé H103             | melamine, laminate, fenix, HPL, metal sheet, metal           | ●           |
| Smart/1 39x39 H73       | melamine, HPL  | ● ■         |
| Smart/1 39x39 H107      | melamine, HPL  | ● ■         |
| Smart/1 48x48 H73       | melamine, HPL  | ● ■         |
| Smart/1 48x48 H107      | melamine, HPL  | ● ■         |
| Smart/2 diam 42 H73     | melamine, HPL  | ● ■         |
| Smart/2 diam 42 H107    | melamine, HPL  | ● ■         |
| Smart/2 diam 50 H73     | melamine, HPL  | ● ■         |
| Smart/2 diam 50 H107    | melamine, HPL  | ● ■         |
| Trampoline H73          | melamine, HPL  | ●           |
| Trampoline H107         | melamine, HPL  | ●           |

## cm 70

|                         |   |     |
|-------------------------|---|-----|
| Break/3                 | melamine, glass, crystalceramic, HPL, metal, metal sheet        | ● ■ |
| Break/4                 | melamine, glass, crystalceramic, HPL, metal, metal sheet        | ● ■ |
| Dama 3G H73             | melamine, laminate, fenix, HPL, metal sheet, metal              | ●   |
| Dama 3G H103            | melamine, laminate, fenix, HPL, metal sheet, metal              | ●   |
| Dama 4G H73             | melamine, laminate, fenix, HPL, metal sheet, metal              | ■   |
| Dama 4G H103            | melamine, laminate, fenix, HPL, metal sheet, metal              | ■   |
| Clessidra               | melamine, laminate, fenix, HPL, metal sheet, metal              | ●   |
| Composit/1 45x45 H73    | glass, melamine, HPL, metal sheet, metal                        | ● ■ |
| Composit/1 45x45 H107   | glass, melamine, HPL, metal sheet, metal                        | ● ■ |
| Composit/2 45x45 H73    | glass, melamine, HPL, metal sheet, metal                        | ● ■ |
| Composit/2 45x45 H107   | glass, melamine, HPL, metal sheet, metal                        | ● ■ |
| Composit/3 diam 45 H73  | glass, melamine, HPL, metal sheet, metal                        | ● ■ |
| Composit/3 diam 45 H107 | glass, melamine, HPL, metal sheet, metal                        | ● ■ |
| Composit/3 diam 55 H73  | glass, melamine, HPL, metal sheet, metal                        | ● ■ |
| Composit/3 diam 55 H107 | glass, melamine, HPL, metal sheet, metal                        | ● ■ |
| Infinity diam 44        | melamine, glass, crystalceramic, HPL, metal, fenix, metal sheet | ●   |
| Plissé H73              | melamine, laminate, fenix, HPL, metal sheet, metal              | ●   |
| Plissé H103             | melamine, laminate, fenix, HPL, metal sheet, metal              | ●   |
| Sintesy                 | glass, melamine, HPL, metal sheet, metal                        | ● ■ |
| Liu H73                 | melamine, HPL, metal sheet, metal                               | ● ■ |
| Liu H107                | melamine, HPL, metal sheet, metal                               | ●   |
| Luna H73                | melamine, HPL, metal sheet, metal                               | ● ■ |
| Luna H107               | melamine, HPL, metal sheet, metal                               | ● ■ |
| Smart/1 39x39 H73       | melamine, HPL, metal sheet, metal                               | ● ■ |
| Smart/1 39x39 H107      | melamine, HPL, metal sheet, metal                               | ● ■ |

## Fix tables

| Model                | Tops' materials                   | Tops' shape |
|----------------------|-----------------------------------|-------------|
| <b>cm 70</b>         |                                   |             |
| Smart/1 48x48 H73    | melamine, HPL, metal sheet, metal | ● ■         |
| Smart/1 48x48 H107   | melamine, HPL, metal sheet, metal | ● ■         |
| Smart/2 diam 42 H73  | melamine, HPL, metal sheet, metal | ● ■         |
| Smart/2 diam 42 H107 | melamine, HPL, metal sheet, metal | ● ■         |
| Smart/2 diam 50 H73  | melamine, HPL, metal sheet, metal | ● ■         |
| Smart/2 diam 50 H107 | melamine, HPL, metal sheet, metal | ● ■         |
| Square 3G H73        | melamine, HPL, metal sheet, metal | ●           |
| Square 3G H107       | melamine, HPL, metal sheet, metal | ●           |
| Square 4G H73        | melamine, HPL, metal sheet, metal | ● ■         |
| Square 4G H107       | melamine, HPL, metal sheet, metal | ● ■         |
| Trampoline H73       | melamine, HPL, metal sheet, metal | ●           |
| Trampoline H107      | melamine, HPL, metal sheet, metal | ●           |
| Nené                 | melamine, HPL                     | ●           |









































## cm 75

|              |  |   |
|--------------|--|---|
| Dama 4G H73  | melamine, laminate, fenix, HPL, metal sheet, metal | ■ |
| Dama 4G H103 | melamine, laminate, fenix, HPL, metal sheet, metal | ■ |
| Ola/4        | metal sheet  | ■ |
| Nené         | melamine, HPL                                      | ■ |











































## cm 80

|                         |  |     |
|-------------------------|--|-----|
| Break/4                 | glass, melamine                                    | ●   |
| Clessidra               | melamine, laminate, fenix, HPL, metal sheet, metal | ●   |
| Dama 3G H73             | melamine, laminate, fenix, HPL, metal sheet, metal | ●   |
| Dama 3G H103            | melamine, laminate, fenix, HPL, metal sheet, metal | ●   |
| Dama 4G H73             | melamine, laminate, fenix, HPL, metal sheet, metal | ■   |
| Dama 4G H103            | melamine, laminate, fenix, HPL, metal sheet, metal | ■   |
| Infinity diam 44        | melamine, glass, crystalceramic, HPL, metal        | ●   |
| Composit/1 45x45 H73    | glass, melamine, HPL, metal sheet, metal           | ● ■ |
| Composit/1 45x45 H107   | glass, melamine, HPL, metal sheet, metal           | ●   |
| Composit/1 55x55 H73    | glass, melamine, HPL, metal sheet, metal           | ● ■ |
| Composit/1 55x55 H107   | glass, melamine, HPL, metal sheet, metal           | ● ■ |
| Composit/2 45x45 H73    | glass, melamine, HPL, metal sheet, metal           | ● ■ |
| Composit/2 45x45 H107   | glass, melamine, HPL, metal sheet, metal           | ●   |
| Composit/2 55x55 H73    | glass, melamine, HPL, metal sheet, metal           | ● ■ |
| Composit/2 55x55 H107   | glass, melamine, HPL, metal sheet, metal           | ● ■ |
| Composit/3 diam 45 H73  | glass, melamine, HPL, metal sheet, metal           | ●   |
| Composit/3 diam 45 H107 | glass, melamine, HPL, metal sheet, metal           | ●   |
| Composit/3 diam 55 H73  | glass, melamine, HPL, metal sheet, metal           | ●   |
| Composit/3 diam 55 H107 | glass, melamine, HPL, metal sheet, metal           | ●   |
| Nené                    | melamine, HPL                                      | ●   |
| Sintesy                 | glass, melamine, HPL, metal sheet, metal           | ● ■ |
| Liu H73                 | melamine, HPL, metal sheet, metal                  | ●   |
| Luna H73                | melamine, HPL, metal sheet, metal                  | ● ■ |
| Luna H107               | melamine, HPL, metal sheet, metal                  | ● ■ |
| Ola/3                   | melamine, HPL, metal sheet, metal                  | ●   |
| Plissé H73              | melamine, laminate, fenix, HPL, metal sheet, metal | ●   |
| Smart/1 39x39 H73       | melamine, HPL                                      | ●   |
| Smart/1 48x48 H73       | melamine, HPL                                      | ● ■ |
| Smart/2 diam 42 H73     | melamine, HPL                                      | ●   |
| Smart/2 diam 42 H107    | melamine, HPL                                      | ●   |
| Smart/2 diam 50 H73     | melamine, HPL                                      | ●   |
| Square 3G H73           | melamine, HPL, metal sheet, metal                  | ●   |

### Fix tables

| Model                  | Tops' materials  | Tops' shape   |
|------------------------|--|---|
| <b>cm 80</b>           |  |   |
| Square 4G H73          | melamine, HPL, metal sheet, metal  |    |
| Trampoline H73         | melamine, HPL, metal sheet, metal  |    |
| Trampoline H107        | melamine, HPL, metal sheet, metal  |    |
| <b>cm 85</b>           |  |   |
| Ola/4                  | metal sheet  |    |
| Nenè                   | melamine, HPL  |   |
| <b>cm 90</b>           |  |   |
| Armando                | metal  |    |
| Clessidra              | melamine, laminate, fenix, HPL, metal sheet, metal                       |    |
| Dama 3G H73            | melamine, laminate, fenix, HPL, metal sheet, metal                       |    |
| Dama 3G H103           | melamine, laminate, fenix, HPL, metal sheet, metal                       |    |
| Infinity diam 44       | melamine, glass, crystalceramic, fenix, laminate                         |    |
| Composit/1 45x45 H73   | glass, melamine, HPL   |    |
| Composit/1 55x55 H73   | glass, melamine, HPL   |    |
| Composit/1 55x55 H107  | glass, melamine, HPL   |    |
| Composit/2 45x45 H73   | glass, melamine, HPL   |    |
| Composit/2 55x55 H73   | glass, melamine, HPL   |    |
| Composit/2 55x55 H107  | glass, melamine, HPL   |    |
| Composit/3 diam 55 H73 | glass, melamine, HPL   |    |
| Plissé H73             | melamine, laminate, fenix, HPL, metal sheet, metal                       |    |
| Sintesy                | glass, melamine, HPL   |    |
| Ola/3                  | melamine, HPL  |    |
| Smart/1 48x48 H73      | melamine, HPL  |   |
| Smart/2 diam 50 H73    | melamine, HPL  |    |
| <b>cm 100</b>          |  |   |
| Infinity diam 70       | melamine, glass, crystalceramic  |    |
| Clessidra              | melamine, laminate, fenix, veneered wood, glass, crystalceramic, marmble |    |
| Composit/2 55x55 H73   | glass, melamine, HPL   |    |
| Composit/1 55x55 H73   | glass, melamine, HPL   |    |
| <b>cm 120</b>          |  |   |
| Clessidra              | melamine, laminate, fenix, veneered wood, glass, crystalceramic, marmble |    |
| Infinity diam 70       | melamine, glass, crystalceramic, fenix, laminate                         |    |
| Woody                  | veneered wood, fenix, laminate, crystalceramic, glass                    |    |
| <b>cm 140</b>          |  |   |
| Akashi                 | veneered wood, MDF, fenix, laminate, ceramic, glass                      |    |
| Brioso                 | glass, veneered  |    |
| Dama H73               | veneered wood wood, melamine, fenix, laminate, HPL                       |    |
| Dama H110              | veneered wood, melamine, fenix, laminate, HPL                            |    |
| Nenè                   | melamine   |    |
| Spike                  | glass  |    |
| Woody                  | veneered wood, fenix, laminate, crystalceramic, glass                    |    |
| Woody                  | veneered wood, fenix, laminate, crystalceramic, glass                    |    |
| <b>cm 150</b>          |  |   |
| Clessidra              | veneered wood, crystalceramic  |    |
| Forest                 | veneered wood, crystalceramic  |    |
| Plissé                 | veneered wood, crystalceramic, marble                                    |    |

### Fix tables

| Model         | Tops' materials   | Tops' shape   |
|---------------|---|---|
| <b>cm 160</b> |   |   |
| Akashi,       | veneered wood, MDF, fenix, laminate, ceramic, glass                     |    |
| Armando       | metal   |    |
| Brioso        | glass, veneered wood  |    |
| Dama H73      | veneered wood, melamine, fenix, laminate, HPL                           |    |
| Dama H110     | veneered wood, melamine, fenix, laminate, HPL                           |    |
| Woody         | veneered wood, fenix, laminate, crystalceramic, glass                   |    |
| <b>cm 180</b> |   |   |
| Akashi        | veneered wood, MDF, fenix, laminate, ceramic, glass                     |    |
| Brioso        | glass   |    |
| Clessidra     | veneered wood, crystalceramic   |    |
| Plissé        | veneered wood, crystalceramic, marble                                   |    |
| Woody         | veneered wood, fenix, laminate, crystalceramic, glass                   |    |
| <b>cm 190</b> |   |   |
| Master        | fenix   |    |
| Lea           | veneered wood, crystalceramic   |    |
| <b>cm 200</b> |   |   |
| Akashi        | veneered wood, MDF, fenix, laminate, ceramic, glass                     |    |
| Armando       | metal   |    |
| Dama H73      | veneered wood, melamine, fenix, laminate, HPL                           |    |
| Dama H110     | veneered wood, melamine, fenix, laminate, HPL                           |    |
| Forest        | solid wood  |    |
| Moonlight     | glass, crystalceramic   |    |
| Pechino       | veneered wood, solid wood, glass  |    |
| Spike         | veneered wood, crystalceramic, marble                                   |    |
| Zeus          | solid wood, veneered wood, glass, crystalceramic                        |    |
| <b>cm 220</b> |   |   |
| Gran Sasso    | glass, crystalceramic   |    |
| Lea           | veneered wood, crystalceramic   |    |
| Moonlight     | glass, crystalceramic   |    |
| Nexus         | glass, crystalceramic   |    |
| Suite         | glass, crystalceramic   |    |
| <b>cm 250</b> |   |   |
| Gran Sasso    | glass, crystalceramic   |    |
| Nexus         | solid wood, glass, crystalceramic                                       |   |
| Pechino       | veneered wood, solid wood, glass  |   |
| Suite         | glass, crystalceramic   |    |
| Zeus          | solid wood, veneered wood, glass, crystalceramic                        |   |
| <b>cm 280</b> |   |   |
| Armando       | metal   |    |
| Forest        | veneered wood, crystalceramic   |   |
| Nexus         | crystalceramic  |   |
| <b>cm 300</b> |   |   |
| Akashi        | veneered wood, MDF, fenix, laminate, ceramic, glass                     |    |
| Clessidra     | melamine, laminate, fenix, veneered wood, glass, crystalceramic, marble |    |

### Extendable tables

| Model            | Tops' materials  | Tops' shape |
|------------------|--|-------------|
| <b>cm 100</b>    |  |             |
| Badù             | melamine, glass, crystalceramic  |             |
| More             | melamine, glass, crystalceramic  |             |
| <b>cm 110 XL</b> |  |             |
| Badù             | melamine, glass, crystalceramic  |             |
| Blade            | melamine, fenix, glass, crystalceramic   |             |
| More             | melamine, fenix, glass, crystalceramic   |             |
| <b>cm 120</b>    |  |             |
| Badù             | melamine, glass, crystalceramic  |             |
| Blade            | melamine, fenix, glass, crystalceramic   |             |
| Diamante         | melamine, glass, crystalceramic  |             |
| Link             | veneered wood, crystalceramic  |             |
| More             | melamine, fenix, glass, crystalceramic   |             |
| Paul             | veneered wood, crystalceramic  |             |
| Woody            | veneered wood, fenix, laminate, crystalceramic, glass                                  |             |
| <b>cm 140</b>    |  |             |
| Apollo           | melamine, MDF, veneered wood, glass, crystalceramic                                    |             |
| Badù             | melamine, MDF, fenix, glass, crystalceramic  |             |
| Blade            | melamine, MDF, fenix, veneered wood, glass, crystalceramic                             |             |
| Diamante         | melamine, MDF, glass, crystalceramic   |             |
| Marcopolo        | glass, crystalceramic  |             |
| Master           | fenix  |             |
| More             | melamine, MDF, fenix, veneered wood, glass, crystalceramic                             |             |
| Woody            | veneered wood, fenix, laminate, crystalceramic, glass                                  |             |
| Woody            | veneered wood, fenix, laminate, crystalceramic, glass                                  |             |
| <b>cm 160</b>    |  |             |
| Akashi           | veneered wood, fenix, laminate   |             |
| Alexander        | glass, crystalceramic  |             |
| Alfred           | glass, crystalceramic  |             |
| Apollo           | melamine, MDF, veneered wood, glass, crystalceramic                                    |             |
| Badù             | veneered wood, medf, melamine, fenix, laminate, crystalceramic, glass, fenix, laminate |             |
| Blade            | melamine, MDF, veneered wood, fenix, glass, crystalceramic                             |             |
| Diamante         | melamine, MDF, glass, crystalceramic   |             |
| Marcopolo        | glass, crystalceramic  |             |
| Master           | fenix  |             |
| More             | veneered wood, MDF, melamine, fenix, laminate, crystalceramic, glass                   |             |
| Pechino          | glass  |             |
| Woody            | veneered wood, fenix, laminate, crystalceramic, glass                                  |             |

### Extendable tables

| Model         | Tops' materials                 | Tops' shape |
|---------------|---------------------------------|-------------|
| <b>cm 180</b> |                                 |             |
| Woody         | veneered wood, fenix, laminate  |             |
| <b>cm 190</b> |                                 |             |
| Apollo        | glass, crystalceramic           |             |
| Pechino       | glass                           |             |
| Diamante      | melamine, glass, crystalceramic |             |
| <b>cm 200</b> |                                 |             |
| Akashi        | veneered wood, fenix, laminate  |             |
| Alexander     | glass, crystalceramic           |             |
| Alfred        | glass, crystalceramic           |             |
| Forest        | glass, crystalceramic           |             |
| Zeus          | veneered wood                   |             |

# Introduction

This Midj price list is a descriptive tool containing the information necessary for the formulation of orders. Here are just a few important instructions to facilitate consultation.

## Product description and finishes

The products are described in the finishes and materials with which they can be made shown in the materials section of our catalog and price list. Customer finishes, if technically practicable, can be supplied on request with a minimum surcharge of 5%.

Information on the stackability of the products is shown (where possible).

The seat heights indicated in the price list and catalog refer to the maximum height measured in the center of the seat.

## Prices

Each item corresponds to a code number and an extension (eg: \_N) that identifies the basic type. For each item and basic type, the VAT excluded prices are shown, for the available upholstery classes. Any increases are shown in the lower section of each item.

## Order confirmation

The confirmation of the order can be made by us only after the complete clarification of the order: therefore samples, fabrics or customer leathers and other important indications must reach us in advance. The delivery term starts from the receipt of the acceptance of the order proposal and/or from the receipt of COM/COL materials. The execution process of all orders will follow our General Conditions of Sale.

## Upholstery - Fabrics

### Fabric consumption

The fabric consumption for each item is expressed in linear meters and is valid for fabrics of height 140 cm cm, solid color and not velvet type. The consumptions indicated refers only to the fabrics present in our box material.

### Customer fabrics and leathers

The fabrics and leathers sent by customers must comply with the following regulations:

- The customer's fabric is available for minimum quantities of 6 pieces.
- In case of quantities of less than 6 pieces in COM/COL, a surcharge of Euro 150 will be applied.
- Before accepting any order in COM/COL, Midj may request a fabric sample for a prior feasibility assessment (minimum sample size 15x15cm). If the preli-

minary test is not exhaustive, Midj may request additional material for a whole sample production. During the production process, if there are difficulties in realization, due to the technical characteristics of the material, it may be necessary to request additional meters and delivery date could be postponed.

- Midj will not be in any way responsible for the appearance, durability, color brightness or any other issues related to the COM/COL material provided by the client.
- Midj's liability in relation to the goods in COM/COL is limited to any defects directly attributable to Midj's production.
- Custom's fabrics or leathers must arrive to our company provided with a transport document or invoice and the "Customer fabric-leather delivery form" shown below, completed in its entirety, specifying the side and direction for the application on the items. In the absence of this important mark, the order will not be produced.
- The fabric sent to us by customers must arrive at our company free of charge and, if coming from countries that are not EEC members, accompanied by the certificate of origin, which is essential for customs clearance in Italy. Any transport and / or customs costs incurred by us will be charged on the invoice.
- In the case of customer fabric with design connection, please send a photo of the fabric and tell us the exact position, in order to provide you with the actual consumption.
- For each roll of customer fabric shipped to us we require the mandatory addition of 1 m of extra fabric for initial testing.
- COL-customer leather: the leather sent to us must be suitable for upholstering small sized chairs and must have a thickness between 0.8 / 1.1 mm. Otherwise, a surcharge of € 10,00 / sqm is applied for extra work to be carried out before upholstery.
- Consumption per customer leather must be requested in advance to the Midj sales office.
- In the case of orders with custom's fabric in odd quantities, the consumption must be calculated as that necessary for the immediately higher unit. Example, for an order of 9 chairs, the material needed should be calculated for 10.
- For quantities over 10 pcs check consumption with the Midj sales office.
- Light colours do not have to be in contact with fabrics or clothes treated with colour addicts not fixed (for example jeans and its derivatives) or with not solid colour treatment, in order to avoid any colour spots and glows for which we CANNOT grant cleaning.

# General terms of sale

## Premises

These general terms of sale, together with the special terms specified in each Order Confirmation, regulate the purchase and sale agreement between Midj S.p.A. (hereinafter called Midj for short) and the purchaser (hereinafter called the Purchaser for short). The general terms of sale are an essential and integral part of the agreement and are intended to be fully accepted by the Purchaser when Midj transmits its ORDER CONFIRMATION.

## Clause 1: Price list and validity

The prices specified on the attached price list, in euros, are gross (before discounts) and do not include V.A.T.; standard packaging for products is included in the prices. The price list cancels and replaces the previous one.

## Clause 2: Changes to the price list

Without giving prior notice, Midj reserves the right to vary the prices and/or products specified on the price list. These changes in prices and/or products shall immediately apply as soon as the Purchaser is informed.

## Clause 3: Purchase orders

The custom must send purchase orders to Midj in writing, indicating the identification code of the selected goods, the model, the quantity, the finishes and the dimensions. Midj reserves the right to accept or reject the order by sending written confirmation. Acceptance of an order is called "Order Confirmation". No purchase order can be canceled or modified after sending the "Order Confirmation".

## Art. 4 Order changes

Changes to an order are to be understood as decreases in quantity, changes in articles, or variations in the finishes of an article. It is possible to request the modification of an order within 24 hours from the confirmation of the "Order Proposal", once the "Order Confirmation" document has been received, no changes will be allowed. In case of changes, the delivery times will start from the date of modification. The increase in quantities is considered a new order, the delivery date will start from the confirmation of the same. It will not be possible to accept more than one change for each order. Any changes to the delivery address upon sending the order confirmation subsequent to the order will be charged € 100 net.

## Clause 5: Cancellation/Suspension of a purchase order

A purchase order cannot be canceled, suspended or postponed without Midj written consent. Any acceptations will be conditioned by the issue of an economic compensation that will take into consideration the costs incurred, the time provided, the use of the equipment and facilities and any further services rendered.

## Clause 6: Delivery terms

Goods are delivered "Ex-works Midj" (according to the current INCOTERMS). Any other term of delivery requested by the Purchaser shall require written authorization from Midj, and stated on the Order Confirmation or other document. It is mandatory for the number of pieces included in the packaging to be specified at the side of each model

from the price list. Any periods of goods storage in Midj warehouse, beyond the period agreed, will be charged on invoice. The Purchaser therefore explicitly accepts that orders, when made for an odd number of a product packed as an even number, shall be automatically increased to the next even number.

## Clause 7 Terms of payment

Payment shall be made by the Purchaser, without any extra charges requested, in compliance with the terms specified on the Order Confirmation. For any delay in payment, Midj shall debit interest on arrears according to the provisions of Legislative Decree nr. 231/2002. Midj reserves the right to suspend all supplies of goods in any case of default even partial, of the agreed terms of payment on the part of the Purchaser. Moreover, Midj reserves the right to change any previously agreed payment terms, without any liability or any right.

## Art. 8: Products for outdoor use

Products marked with the specific symbol are guaranteed for outdoor use. Storage in a protected area is recommended in case of long periods of inactivity. Terraces, porches, patios and verandas, as well as ships, spas and locations near the sea are to be considered external environments, even if not directly exposed to atmospheric agents.

## Clause 9: Shipment and transport terms

The date of preparation of the ordered products is indicated in the "Order Confirmation" document and is to be considered indicative. A delay shall not constitute a justifiable reason for cancelling an order or for any type of compensation and/or indemnity, unless otherwise agreed between the parties. Orders shall not be changed or cancelled later than 1 days after being confirmed by Midj. In the event of cancellation, an amount shall be charged equal to 20% of the value of the accepted order. Any damage to goods due to transport or any differences in quantity/quality to those specified on the delivery note must be reported at the time of unloading and indicated on the delivery note. Failing this, Midj shall not replace any delivered goods which have been damaged due to transport or which are incorrect.

## Art. 10 Packaging

The packaging made by Midj is suitable for the transport of goods by road; the cardboard boxes must always be handled keeping the side indicated. Where possible, out standard packaging is allowed on request with a net charge of €10 for each package. Any specific packaging for transport by air must be specified at the time of the order. The supplement for special packaging is €50 net per pallet. Also, in case of need for a pallet compliant with the FAO ISPM 15 protocol, the request must be made at the time of the order and provides for a supplement of € 25 net for each pallet.

## Clause 11: Customer fabrics and leathers

Fabrics and leathers sent by the customers must be provided with detailed documentation, which highlights materials specifications, Midj PO reference, as well as the techni-

cal specifications indicated in the "Introduction" section. In the absence of this important document, the order will not be processed. Materials sent to us by the customers have to be delivered to our company in free port terms and, if coming from extra-CEE countries, they have to arrive with the certificate of origin, which is mandatory for clearance in Italy. Any transport/clearance costs, that we will afford, will be charged on invoice.

#### **Clause 12 Claims and warranty**

The product warranty only covers the total replacement of the product or faulty parts due to manufacturing defects that are directly attributable to Midj. Any claims concerning the packaging, quantity, number or external characteristics of products (apparent defects), must be communicated to Midj by email together with photographic material, under penalty of forfeiture, within eight days of the date of receiving the goods. Any claims concerning defects that cannot be identified by examination at the time of delivery (non-visible defects) must be communicated to Midj by email together with photographic material, under penalty of forfeiture, within eight days of the date the defect was discovered, and in any case, no later than 12 (twelve) months after delivery. The warranty does not include any defects in the product caused by incorrect assembly, improper use or any use other than its intended use, non-observance of the use and maintenance instructions, or wear and tear. Any claim, dispute or allegation not ascribable to product defects may only be deemed valid if communicated in writing to Midj within eight days of the date of receiving the related invoice.

#### **Clause 13: Returned goods**

No returns shall be accepted unless previously communicated in writing and explicitly authorized in writing by Midj. Any returned goods must be returned, at the very latest, within 60 days of the approval given by Midj. Returns must only be made using vehicles sent by Midj and accompanied by a related document authorizing their return. It must be pointed that carriers may only be used upon prior written authorization from Midj. If the goods to be returned are not made available for collection twice running when the vehicle sent by Midj arrives, any authorization given for their return shall be cancelled and any goods sent as replacements shall be duly paid. When goods are returned, Midj shall immediately check their condition and, in the event of damage not ascribable to Midj, the value of individual pieces shall not be considered. If the goods are damaged, due to the absence of their original packaging (or any packaging required to keep the goods intact during transport), Midj shall be entitled to charge the Purchaser any costs required for repairs, or may not accept the goods. When goods are returned, a credit note shall be issued, which, in any case, shall be based on the prices of the specific invoice, for which details must be strictly specified on the delivery note for the returned goods. Any goods sent as replacements shall be duly invoiced. If the replaced goods are not returned within 60 days, Midj shall refuse to collect them and shall issue a bank order for full

payment. In the event of non-payment, Midj reserves the right to suspend deliveries as specified in CLAUSE 7 above. For replacements under warranty which involve returns, Midj reserves the right to invoice the goods sent as replacements if no manufacturing defects ascribable to Midj are found in these returned goods. The value of the returned goods shall not be compensated with the value of the goods to be delivered.

#### **Clause 14: Samples allowance**

The colors of the photographic materials in the present list, in catalogs and in the material samples, are indicative as it is technically impossible to reproduce the tones and finishes. Midj disclaims any responsibility for color matching requests with previously purchased articles.

#### **Clause 15: Technical data, use and product maintenance sheet**

In compliance with Italian Law nr.126 of 10/04/91 and Ministerial Decree nr.101 of 08/02/97, Midj provides a "Technical Sheet" in all its packages, which must be visible on all goods displayed. Midj shall not be held liable for any non-observance of this obligation on the part of the Purchaser.

#### **Clause 16: Retention of title**

It is agreed that delivered products shall remain the property of Midj until full payment of the price has been made by the Purchaser, even when any of the original delivered goods have been customized, finished and/or altered.

#### **Clause 17: Court of jurisdiction**

Any dispute arising from the interpretation and execution of the purchase and sale contract governed by these general terms of sale shall be settled by the Court of Pordenone. However, Midj reserves the right to choose the Court where the Purchaser has its legal offices and /or its main offices.

# C.O.M. and C.O.L. delivery form

Customer: \_\_\_\_\_

Shipping date: \_\_\_\_\_

Order nr. or Proforma Invoice nr: \_\_\_\_\_

Customer reference: \_\_\_\_\_

Model name to be upholstered: \_\_\_\_\_

Name of leather or fabric manufacturer: \_\_\_\_\_

Name of fabric or leather collection: \_\_\_\_\_

Color: \_\_\_\_\_

Quantity: \_\_\_\_\_

Special instructions for cutting and upholstery: \_\_\_\_\_

\_\_\_\_\_

\_\_\_\_\_

- A) Solid color fabric
- B) Fabric with horizontal orientation
- C) Fabric with vertical orientation
- D) Patterned fabric

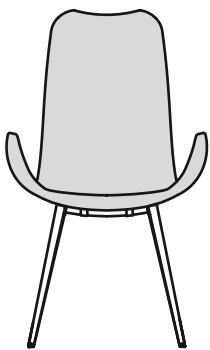

A

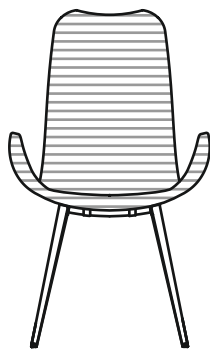

B

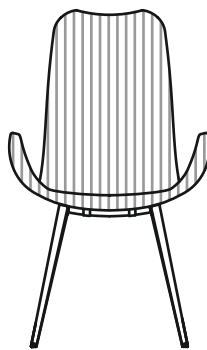

C

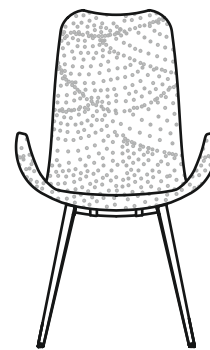



D

Please send the materials to the following address:  
Midj warehouse, Via Guglielmo Marconi 39 - 33079 Ramuscello di Sesto al Reghena (PN) - Italy  
Tel +39 0434 690122

# Table tops

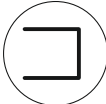
# Legend of the icons

|                 | Models available  | thickness | edge  |
|-----------------|---|-----------|---|
| <b>HPL</b>      |   |           |   |
| ø60             | Composit h75-h110<br>Smart h75-h110<br>Break 3-4, Infinity<br>Italia<br>Trampoline h75-h110   | cm 1      |    |
| ø70             | Composit h75-h110<br>Smart h75-h110<br>Break 3-4<br>Infinity<br>Italia<br>Trampoline h75      | cm 1      |   |
| ø79,2           | Composit h75<br>Smart h75<br>Break 4<br>Infinity<br>Four                                      | cm 1      |   |
| 60x60           | Composit h75-h110<br>Smart h75-h110<br>Italia<br>Sintesy                                      | cm 1      |   |
| 70x70           | Composit h75-h110<br>Smart h75-h110<br>Italia<br>Sintesy                                      | cm 1      |   |
| 79,2x79,2       | Composit h75<br>Smart h75<br>Four<br>Sintesy  | cm 1      |   |
| <b>MELAMINE</b> |   |           |   |
| ø60             | Composit h75-h110<br>Smart h75-h110<br>Break 3-4<br>Infinity<br>Italia<br>Trampoline h75-h110 | cm 1,8/2  |  |
| ø70             | Composit h75-h110<br>Smart h75-h110<br>Break 3-4<br>Infinity<br>Italia<br>Trampoline h75      | cm 1,8/2  |   |
| ø80             | Composit h75<br>Smart h75<br>Break 4<br>Infinity<br>Four                                      | cm 1,8/2  |   |
| ø100            | Infinity  | cm 1,8/2  |   |
| ø120            | Infinity  | cm 1,8/2  |   |
| 60x60           | Composit h75-h110<br>Smart h75-h110<br>Italia<br>Sintesy                                      | cm 1,8/2  |   |
| 70x70           | Composit h75-h110<br>Smart h75-h110<br>Italia<br>Sintesy                                      | cm 1,8/2  |   |
| 80x80           | Composit h75<br>Smart h75<br>Four<br>Sintesy  | cm 1,8/2  |   |
| <b>GLASS</b>    |   |           |   |
| ø60             | Composit h75-h110<br>Face H75-H110<br>Infinity  | cm 1      |  |
| ø80             | Composit h75<br>Face H75<br>Infinity  | cm 1      |   |
| ø100            | Infinity  | cm 1      |   |
| ø120            | Infinity  | cm 1      |   |

weight of  
the packed product in Kg



quantity per box



box volume in m3



n° boxes



COM consumption



COL consumption



to assemble



stackable



swivel chair



swivel and adjustable chair



outdoor finish



finish suitable for seaside area



tested product



certification IIM



fire retardant



**A** **Silvy SB, SBR; SA, SAR - Shell in hide, fabric or leather** **B**  
 Frame in: metal or upholstered **B**

| <b>A</b> Model  | Cod.     | <b>E</b> Mod. | Frame    | <b>G</b> Shell |       |       |       |       |       |       |       | Optional | Q.tà          | colli | Kg | M <sup>3</sup> |      |
|---|----------|---------------|----------|----------------|-------|-------|-------|-------|-------|-------|-------|----------|---------------|-------|----|----------------|------|
| CU  |          |               |          |                |       |       |       |       |       |       |       |          |               |       |    |                |      |
| <b>Chair SILVY SB M TS</b>  | <b>B</b> |               | <b>F</b> |                |       |       |       |       |       |       |       |          |               |       |    |                |      |
|  | S1490MT  | SB            | MI       | 209 €          | 228 € | 274 € | 302 € | 402 € | 308 € | 364 € | 209 € | 274 €    | FM-M3<br>ES-1 | 2     | 1  | 9              | 0.33 |
| <b>S</b>  | <b>D</b> |               |          | <b>H</b>       |       |       |       |       |       |       |       | <b>I</b> | <b>O</b>      |       |    |                |      |

**COM/COL - Minimum Q.ty 6 pc. for each material. For weft or patterned fabrics see specific pages**

|            |                                 |            |               |
|------------|---------------------------------|------------|---------------|
| <b>COM</b> | Mtl. 1.00 h. 1.40 Each <b>P</b> | <b>COL</b> | Mq. 1.65 Each |
|------------|---------------------------------|------------|---------------|

### Frame finishes

#### Metal

**MI** WHITE **BB**, BROWN **E6**, SAND **EC**, WHITE PEARL **EF**, GRAPHITE **EG**, BLACK **EN**

### Shell finishes

#### Upholstery

**TA** FAUX LEATHER **Secret**, FABRIC **Mirage**, FABRIC **Cotton Club**, FABRIC **Renewed Loop**

**TB** FAUX LEATHER **Vintage**, FABRIC **Fenix Wool**, FABRIC **Visual**, FABRIC **Manhattan**, FABRIC **Novabuk**, FABRIC **Network**, FABRIC **Gyre**

**TC** VELVET SUPERB, FABRIC **Second**, FABRIC **Main Line Flax**, FABRIC **Oceanic**, FABRIC **Jumper**, FABRIC **Flame**, FABRIC **Ouche**, FABRIC **Plain**, FABRIC **Gemma**, FABRIC **Caltagirone II4**

**TD** FABRIC **Yoredale**, FABRIC **Remix 3**

**TE** FABRIC **Uniform Melange**

**SF** LEATHER **Fiore**

**SV** LEATHER **Vintage**

**CU** HIDE

#### Optionals:

|              |                        | Valore | Opzioni/Note     |
|--------------|------------------------|--------|------------------|
| <b>FM-M3</b> | Indoor glossy metal M3 | + 21 € | CHROME <b>CC</b> |
| <b>ES-1</b>  | Fireproof foam         | + 7 €  | ES-1             |

### Silvy SB

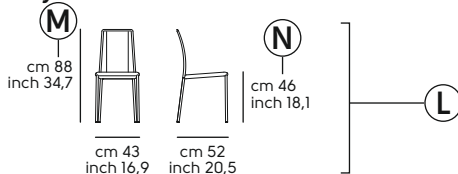

- A** model name
- B** model description
- C** image of model
- D** code article
- E** model / frame type
- F** frame finishes
- G** shell finishes
- H** prices
- I** optionals codes
- L** drawing with dimensions in cm/inch
- M** total height
- N** seat height
- O** packaging data
- P** COM/COM information
- Q** standard finishes variants
- R** optional descriptions and increases
- S** additional icons

**Table Diamante**  
Frame in: metal

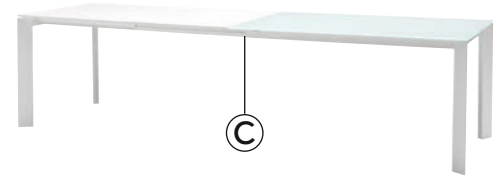

| <b>A</b> Version                      | Cod.     | Legs | Frame | <b>G</b> Top | Optional | <b>G.tà</b> | <b>colli</b> | <b>Kg</b> | <b>M³</b> |
|---------------------------------------|----------|------|-------|--------------|----------|-------------|--------------|-----------|-----------|
| <b>Diamante MDF</b><br>Top 19 mm. thk |          |      |       |              |          |             |              |           |           |
|                                       | <b>D</b> |      |       | LM1          |          |             |              |           |           |
| 120x 80                               | T0160012 |      |       | 1.210 €      |          | 1           | 3            | 38        | 0.20      |
| 140x 90                               | T0160014 | M1   | M1    | 1.370 €      | FM-M2    | 1           | 3            | 43.4      | 0.24      |
| 160x 90                               | T0160016 |      |       | 1.510 €      |          | 1           | 3            | 44.7      | 0.25      |

**Note:** For Glass or Crystal Ceramic tops, extensions Only in MDF or HPL - Table 180x100 NO Ceramic K26

### Frame finishes

| Metal     |   |
|-----------|---|
| <b>MI</b> | WHITE <b>BB</b> , BROWN <b>E6</b> , SAND <b>EC</b> , WHITE PEARL <b>EF</b> , GRAPHITE <b>EG</b> , BLACK <b>EN</b> |

### Legs finishes

| Metal     |   |
|-----------|---|
| <b>MI</b> | WHITE <b>BB</b> , BROWN <b>E6</b> , SAND <b>EC</b> , WHITE PEARL <b>EF</b> , GRAPHITE <b>EG</b> , BLACK <b>EN</b> |

### Top and extensions finishes

| Melamine   |  |
|------------|--|
| <b>HLI</b> | WHITE <b>M01</b> , GRAFITE <b>M02</b> , BLACK <b>M04</b> , SAND <b>M07</b> |

| Lacquered MDF |   |
|---------------|---|
| <b>LMI</b>    | GRAPHITE GREY <b>G02</b> , BLACK <b>G04</b> , WHITE <b>G05</b> , SAND <b>G07</b> , BROWN <b>G41</b> |

| Optionals:   |                      |         |  |
|--------------|----------------------|---------|--|
|              |                      | Valore  | Opzioni/Note   |
| <b>FM-M2</b> | Indoor matt metal M2 | + 180 € | ASH GREY <b>ES</b> , BLUE SAPPHIRE <b>EE</b> , BLUE TURQUOISE <b>EH</b> , BRONZE <b>E2</b> , BULGARO RED <b>FP</b> , CHERRY RED <b>EQ</b> , DARK GREEN <b>EL</b> , FACEPOWDER PINK <b>E8</b> , FANGO <b>E3</b> , GOLDEN YELLOW <b>EO</b> , LIGHT BLUE <b>EO</b> , LIGHT GREY <b>ET</b> , OCEAN BLUE <b>EI</b> , OCHER YELLOW <b>E7</b> , PAPAYA ORANGE <b>EA</b> , PASTEL YELLOW <b>E4</b> , PINE GREEN <b>EJ</b> , RED <b>ER</b> , SAGE GREEN <b>E9</b> |

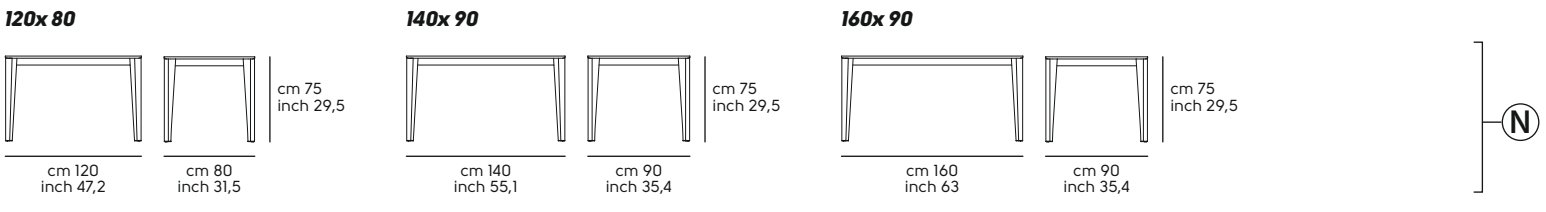

- A** model name
- B** model description
- C** image of model
- D** code article
- E** legs finish
- F** frame finishes
- G** top finishes
- H** prices
- I** packaging data
- L** frame finishes variants
- M** top and extensions finishes
- N** drawing with dimensions in cm/inch

**Frame Liù**

Frame in: metal - wood Top NOT included

| Version  | Cod.     | H     | Legs | Metal Insert   | Optional | Q.tà | colli | Kg  | M <sup>3</sup> |
|--|----------|-------|------|----------------|----------|------|-------|-----|----------------|
|  |          |       |      |                |          |      |       |     |                |
| <b>LIU' ML H 73</b><br>Top Max 70x70 - Ø 80<br> | T1285B04 | H. 73 | LF1  | 253 €<br>291 € | PD-F0    | 1    | 1     | 6.7 | 0.21           |

**Legs finishes**

**Wood**

**LF1** Ash wood stained BLACK **F04**, Ash wood stained WHITE **F05**, Ash wood stained CHERRY RED **F09**, Ash wood stained FLAMED WALNUT **F24**, Ash wood stained DARK BROWN **F26**, Ash wood stained NATURAL **F40**, Ash wood stained NATURAL OAK **F52**, Ash wood stained WHITENED **F60**, Ash wood stained DESERT **F61**, Ash wood stained LIGHT GREY **F62**, Ash wood stained DARK GREY **F63**

**Insert finishes**

**Metal**

**M1** WHITE **BB**, BROWN **E6**, SAND **EC**, WHITE PEARL **EF**, GRAPHITE **EG**, BLACK **EN**

**M2** LIGHT BLUE **E0**, OCEAN BLUE **E1**, BRONZE **E2**, FANGO **E3**, PASTEL YELLOW **E4**, OCHER YELLOW **E7**, FACEPOWDER PINK **E8**, SAGE GREEN **E9**, PAPAYA ORANGE **EA**, BLUE SAPPHIRE **EE**, BLUE TURQUOISE **EH**, PINE GREEN **EJ**, DARK GREEN **EL**, GOLDEN YELLOW **EO**, CHERRY RED **EQ**, RED **ER**, ASH GREY **ES**, LIGHT GREY **ET**, BULGARO RED **FP**

**Optionals:**

|                            | Valore | Opzioni/Note |
|----------------------------|--------|--------------|
| <b>PD-F0</b> Felt pad feet | + 6 €  | PD-F0        |

**Liù ML H 73**

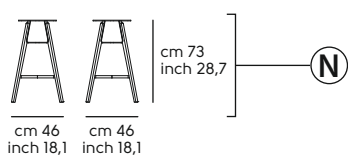

- (A)** model name
- (B)** model description
- (C)** image of model
- (D)** code article
- (E)** legs finish
- (F)** finishes
- (G)** prices
- (H)** optionals code
- (I)** packaging data
- (L)** standard finishes variants
- (M)** optionals description and increases
- (N)** drawing with dimensions in cm/inch

**A**  
**Top Metal**

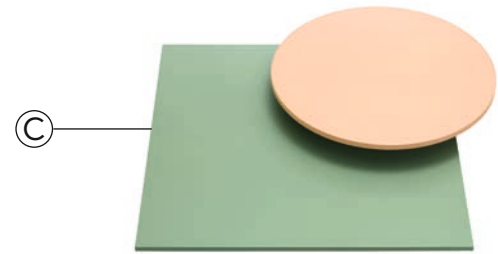

| <b>B</b> Version | Cod. | Thickness | Finish | Optional | Q.tà | collì | Kg | M³ |
|------------------|------|-----------|--------|----------|------|-------|----|----|
|------------------|------|-----------|--------|----------|------|-------|----|----|

**Metal Round Top**

|          |          | <b>D</b> |     | M1    | M2    | O1    | O2    |   |   |      |      |
|----------|----------|----------|-----|-------|-------|-------|-------|---|---|------|------|
| Top Ø 60 | <b>G</b> | TT15LD06 | 1.5 | 132 € | 159 € | 159 € | 187 € | 1 | 1 | 9    | 0.04 |
| Top Ø 70 |          | TT15LD07 |     | 158 € | 188 € | 186 € | 214 € | 1 | 1 | 11.5 | 0.05 |
| Top Ø 80 |          | TT15LD08 |     | 223 € | 252 € | 252 € | 278 € | 1 | 1 | 14.5 | 0.07 |

**Note:**  
NOT AVAILABLE in Industrial E5 finish - Top MDF hydrophobic + metal

**Top finishes**

**Metal**

|           |   |
|-----------|---|
| <b>M1</b> | WHITE <b>BB</b> , BROWN <b>E6</b> , SAND <b>EC</b> , WHITE PEARL <b>EF</b> , GRAPHITE <b>EG</b> , BLACK <b>EN</b>   |
| <b>M2</b> | LIGHT BLUE <b>E0</b> , OCEAN BLUE <b>E1</b> , FANGO <b>E3</b> , PASTEL YELLOW <b>E4</b> , OCHER YELLOW <b>E7</b> , FACEPOWDER PINK <b>E8</b> , SAGE GREEN <b>E9</b> , PAPAYA ORANGE <b>EA</b> , BLUE SAPPHIRE <b>EE</b> , BLUE TURQUOISE <b>EH</b> , PINE GREEN <b>EJ</b> , DARK GREEN <b>EL</b> , GOLDEN YELLOW <b>EO</b> , CHERRY RED <b>EQ</b> , RED <b>ER</b> , ASH GREY <b>ES</b> , LIGHT GREY <b>ET</b> , BRONZE <b>EZ</b> + TRANSP., BULGARO RED <b>FP</b> |

**Metal Outdoor**

|           |   |
|-----------|---|
| <b>O1</b> | Outdoor BROWN <b>E6</b> , Outdoor WHITE <b>BB</b> , Outdoor SAND <b>EC</b> , Outdoor WHITE PEARL <b>EF</b> , Outdoor GRAFITE <b>EG</b> , Outdoor BLACK <b>EN</b>  |
| <b>O2</b> | Outdoor LIGHT BLUE <b>E0</b> , Outdoor OCEAN BLUE <b>E1</b> , Outdoor FANGO <b>E3</b> , Outdoor PASTEL YELLOW <b>E4</b> , Outdoor OCHER YELLOW <b>E7</b> , Outdoor FACEPOWDER PINK <b>E8</b> , Outdoor SAGE GREEN <b>E9</b> , Outdoor BLUE SAPPHIRE <b>EE</b> , Outdoor BLUE TURQUOISE <b>EH</b> , Outdoor PINE GREEN <b>EJ</b> , Outdoor DARK GREEN <b>EL</b> , Outdoor GOLD YELLOW <b>EO</b> , Outdoor RED BULGARO <b>FP</b> , Outdoor CHERRY RED <b>EQ</b> , Outdoor RED <b>ER</b> , Outdoor ASH GREY <b>ES</b> , Outdoor LIGHT GREY <b>ET</b> , Outdoor PAPAYA ORANGE <b>EA</b> , Outdoor BRONZE <b>EZ</b> +TRANSP. |

**A** model finish

**B** model name

**C** image of model

**D** code article

**E** prices

**F** finishes

**G** dimensions

**H** packaging data

**I** finishes variants



# Chairs



# Amelie design Roberto Paoli

## Amelie S, P - Seat and back in fabric or leather

Frame in: metal

| Model   | Code    | Mod. | Frame | Seat and Backrest |       |       |       |       |       |       |       |       | Optional                         | Q.ty | boxes | Kg | M <sup>3</sup> |
|---|---------|------|-------|-------------------|-------|-------|-------|-------|-------|-------|-------|-------|----------------------------------|------|-------|----|----------------|
|   |         |      |       | TA                | TB    | TC    | TD    | TE    | SF    | SV    | COM   | COL   |                                  |      |       |    |                |
| <br><b>Chair AMELIE S M TS</b> | S2260SO | S    | M1    | 411 €             | 445 € | 498 € | 546 € | 799 € | 519 € | 614 € | 411 € | 500 € | FM-M2<br>FM-M3<br>FM-M4<br>PD-F0 | 2    | 1     | 17 | 0.30           |

**COM/COL - Minimum Q.ty 6 pc. for each material. For weft or patterned fabrics see specific pages**

|   |  |   |    |       |       |       |       |       |       |       |       |       |                                  |   |   |    |       |
|---|--|---|----|-------|-------|-------|-------|-------|-------|-------|-------|-------|----------------------------------|---|---|----|-------|
| <br>Mtl. 0.94 h. 1.40 Each         | <br>Mq. 2.20 Each |   |    |       |       |       |       |       |       |       |       |       |                                  |   |   |    |       |
| <br><b>Armchair AMELIE P M TS</b> | S2260PO  | P | M1 | 473 € | 519 € | 594 € | 656 € | 998 € | 633 € | 748 € | 473 € | 594 € | FM-M2<br>FM-M3<br>FM-M4<br>PD-F0 | 2 | 1 | 18 | 0.294 |

**COM/COL - Minimum Q.ty 6 pc. for each material. For weft or patterned fabrics see specific pages**

|   |  |
|---|--|
| <br>Mtl. 1.24 h. 1.40 Each | <br>Mq. 2.77 Each |
|---|--|

**Note:**

TS Front and Back covering available in two-tone or bi-material. Reference price in the upper category

**Frame finishes**

|              |   |
|--------------|---|
| <b>Metal</b> |   |
| <b>MI</b>    | WHITE <b>BB</b> , BROWN <b>E6</b> , SAND <b>EC</b> , WHITE PEARL <b>EF</b> , GRAPHITE <b>EG</b> , BLACK <b>EN</b> |

**Seat and Back finishes**

|                   |   |           |  |
|-------------------|---|-----------|--|
| <b>Upholstery</b> |   |           |  |
| <b>TA</b>         | FAUX LEATHER <b>Secret</b> , FABRIC <b>Mirage</b> , FABRIC <b>Cotton Club</b> , FABRIC <b>Renewed Loop</b>  | <b>TB</b> | FAUX LEATHER <b>Vintage</b> , FABRIC <b>Fenix Wool</b> , FABRIC <b>Visual</b> , FABRIC <b>Manhattan</b> , FABRIC <b>Novabuk</b> , FABRIC <b>Network</b> , FABRIC <b>Gyre</b> |
| <b>TC</b>         | VELVET SUPERB, FABRIC <b>Second</b> , FABRIC <b>Main Line Flax</b> , FABRIC <b>Oceanic</b> , FABRIC <b>Jumper</b> , FABRIC <b>Flame</b> , FABRIC <b>Ouche</b> , FABRIC <b>Plain</b> , FABRIC <b>Gemma</b> , FABRIC <b>Caltagirone 114</b> | <b>TD</b> | FABRIC <b>Yoredale</b> , FABRIC <b>Remix 3</b>   |
| <b>TE</b>         | FABRIC <b>Uniform Melange</b>   | <b>SF</b> | LEATHER <b>Fiore</b>   |
| <b>SV</b>         | LEATHER <b>Vintage</b>  |           |  |

**Options:**

|              |                        | Value   | Options/notes  |
|--------------|------------------------|---------|--|
| <b>FM-M2</b> | Indoor matt metal M2   | + 57 €  | ASH GREY <b>ES</b> , BLUE SAPPHIRE <b>EE</b> , BLUE TURQUOISE <b>EH</b> , BRONZE <b>E2</b> , BULGARO RED <b>FP</b> , CHERRY RED <b>EQ</b> , DARK GREEN <b>EL</b> , FACEPOWDER PINK <b>E8</b> , FANGO <b>E3</b> , GOLDEN YELLOW <b>EO</b> , LIGHT BLUE <b>EO</b> , LIGHT GREY <b>ET</b> , OCEAN BLUE <b>E1</b> , OCHER YELLOW <b>E7</b> , PAPAYA ORANGE <b>EA</b> , PASTEL YELLOW <b>E4</b> , PINE GREEN <b>EJ</b> , RED <b>ER</b> , SAGE GREEN <b>E9</b> |
| <b>FM-M3</b> | Indoor glossy metal M3 | + 47 €  | CHROME <b>CC</b>   |
| <b>FM-M4</b> | Indoor glossy Metal M4 | + 166 € | BLACK NICKEL <b>DZ</b> , CHAMPAGNE GOLD <b>DG</b> , GOLDEN BRONZE <b>DB</b> , MATT BLACK NICKEL <b>DY</b> , MATT GOLDEN BRONZE <b>DC</b> , PINK GOLD <b>DR</b>   |
| <b>PD-F0</b> | Felt pad feet          | + 6 €   | PD-F0  |

**Amelie S**

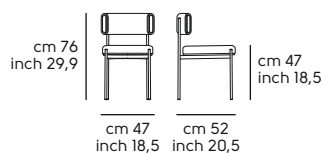

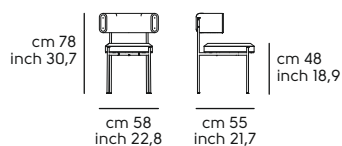

**Amelie P**





## Amelie H65, H75 - Seat and back in fabric or leather

Frame in: metal

| Model  | Code    | Mod. | Frame | Seat and Backrest |       |       |       |       |       |       |       |       | Optional                         | Q.ty | boxes | Kg   | M <sup>2</sup> |
|--|---------|------|-------|-------------------|-------|-------|-------|-------|-------|-------|-------|-------|----------------------------------|------|-------|------|----------------|
|  |         |      |       | TA                | TB    | TC    | TD    | TE    | SF    | SV    | COM   | COL   |                                  |      |       |      |                |
| <br>Stool AMELIE H65 M TS | S2260HO | H65  | MI    | 523 €             | 557 € | 613 € | 658 € | 933 € | 642 € | 726 € | 523 € | 613 € | FM-M2<br>FM-M3<br>FM-M4<br>PD-F0 | 1    | 1     | 10   | 0.23           |
| <br>Stool AMELIE H75 M TS | S2260JO | H75  | MI    | 534 €             | 568 € | 623 € | 669 € | 943 € | 652 € | 736 € | 534 € | 623 € | FM-M2<br>FM-M3<br>FM-M4<br>PD-F0 | 1    | 1     | 10.5 | 0.25           |

COM/COL - Minimum Q.ty 6 pc. for each material. For weft or patterned fabrics see specific pages

|  |   |
|--|---|
|  Mtl. 0.94 h. 1.40 Each |  Mq. 1.95 Each |
|--|---|

**Note:**

TS Front and Back covering available in two-tone or bi-material. Reference price in the upper category

**Frame finishes**

**Metal**

|           |   |
|-----------|---|
| <b>MI</b> | WHITE <b>BB</b> , BROWN <b>E6</b> , SAND <b>EC</b> , WHITE PEARL <b>EF</b> , GRAPHITE <b>EG</b> , BLACK <b>EN</b> |
|-----------|---|

**Seat and Back finishes**

**Upholstery**

|           |   |           |  |
|-----------|---|-----------|--|
| <b>TA</b> | FAUX LEATHER <b>Secret</b> , FABRIC <b>Mirage</b> , FABRIC <b>Cotton Club</b> , FABRIC <b>Renewed Loop</b>  | <b>TB</b> | FAUX LEATHER <b>Vintage</b> , FABRIC <b>Fenix Wool</b> , FABRIC <b>Visual</b> , FABRIC <b>Manhattan</b> , FABRIC <b>Novabuk</b> , FABRIC <b>Network</b> , FABRIC <b>Gyre</b> |
| <b>TC</b> | VELVET SUPERB, FABRIC <b>Second</b> , FABRIC <b>Main Line Flax</b> , FABRIC <b>Oceanic</b> , FABRIC <b>Jumper</b> , FABRIC <b>Flame</b> , FABRIC <b>Ouche</b> , FABRIC <b>Plain</b> , FABRIC <b>Gemma</b> , FABRIC <b>Caltagirone II4</b> | <b>TD</b> | FABRIC <b>Yoredale</b> , FABRIC <b>Remix 3</b>   |
| <b>TE</b> | FABRIC <b>Uniform Melange</b>   | <b>SF</b> | LEATHER <b>Fiore</b>   |
| <b>SV</b> | LEATHER <b>Vintage</b>  |           |  |

**Optionals:**

|              | Value                  | Options/notes  |
|--------------|------------------------|--|
| <b>FM-M2</b> | Indoor matt metal M2   | + 57 €   |
|              |                        | ASH GREY <b>ES</b> , BLUE SAPPHIRE <b>EE</b> , BLUE TURQUOISE <b>EH</b> , BRONZE <b>E2</b> , BULGARO RED <b>FP</b> , CHERRY RED <b>EQ</b> , DARK GREEN <b>EL</b> , FACEPOWDER PINK <b>E8</b> , FANGO <b>E3</b> , GOLDEN YELLOW <b>EO</b> , LIGHT BLUE <b>EO</b> , LIGHT GREY <b>ET</b> , OCEAN BLUE <b>EI</b> , OCHER YELLOW <b>E7</b> , PAPAYA ORANGE <b>EA</b> , PASTEL YELLOW <b>E4</b> , PINE GREEN <b>EJ</b> , RED <b>ER</b> , SAGE GREEN <b>E9</b> |
| <b>FM-M3</b> | Indoor glossy metal M3 | + 47 €   |
|              |                        | CHROME <b>CC</b>   |
| <b>FM-M4</b> | Indoor glossy Metal M4 | + 166 €  |
|              |                        | BLACK NICKEL <b>DZ</b> , CHAMPAGNE GOLD <b>DG</b> , GOLDEN BRONZE <b>DB</b> , MATT BLACK NICKEL <b>DY</b> , MATT GOLDEN BRONZE <b>DC</b> , PINK GOLD <b>DR</b>   |
| <b>PD-F0</b> | Felt pad feet          | + 6 €  |
|              |                        | PD-F0  |

**Amelie H65**

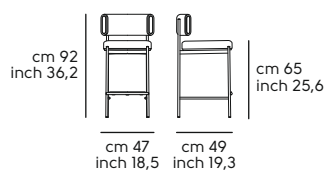

**Amelie H75**

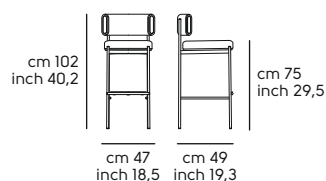



## Amelie DP - Seat and back in fabric or leather

Frame in: metal

| Model   | Code     | Mod. | Frame | Seat and Backrest |       |       |       |         |       |       |       |       | Optional | Q.ty | boxes | Kg | M³   |
|---|----------|------|-------|-------------------|-------|-------|-------|---------|-------|-------|-------|-------|----------|------|-------|----|------|
|   |          |      |       | TA                | TB    | TC    | TD    | TE      | SF    | SV    | COM   | COL   |          |      |       |    |      |
|  Office Arm. AMELIE DP TS | S2260DPO | DP   | MI    | 619 €             | 665 € | 739 € | 802 € | 1.172 € | 779 € | 893 € | 619 € | 739 € | FM-M2    | 1    | 2     | 14 | 0.25 |

COM/COL - Minimum Q.ty 6 pc. for each material. For weft or patterned fabrics see specific pages

|   |                        |  |               |
|---|------------------------|--|---------------|
|  <b>COM</b> | Mtl. 1.24 h. 1.40 Each |  <b>COL</b> | Mq. 2.77 Each |
|---|------------------------|--|---------------|

**Note:**  
TS Front and Back covering available in two-tone or bi-material. Reference price in the upper category

### Frame finishes

| Metal     |   |
|-----------|---|
| <b>MI</b> | WHITE <b>BB</b> , BROWN <b>E6</b> , SAND <b>EC</b> , WHITE PEARL <b>EF</b> , GRAPHITE <b>EG</b> , BLACK <b>EN</b> |

### Seat and Back finishes

| Upholstery |   |
|------------|---|
| <b>TA</b>  | FAUX LEATHER <b>Secret</b> , FABRIC <b>Mirage</b> , FABRIC <b>Cotton Club</b> , FABRIC <b>Renewed Loop</b>  |
| <b>TB</b>  | FAUX LEATHER <b>Vintage</b> , FABRIC <b>Fenix Wool</b> , FABRIC <b>Visual</b> , FABRIC <b>Manhattan</b> , FABRIC <b>Novabuk</b> , FABRIC <b>Network</b> , FABRIC <b>Gyre</b>  |
| <b>TC</b>  | VELVET SUPERB, FABRIC <b>Second</b> , FABRIC <b>Main Line Flax</b> , FABRIC <b>Oceanic</b> , FABRIC <b>Jumper</b> , FABRIC <b>Flame</b> , FABRIC <b>Ouche</b> , FABRIC <b>Plain</b> , FABRIC <b>Gemma</b> , FABRIC <b>Caltagirone 114</b> |
| <b>TD</b>  | FABRIC <b>Yoredale</b> , FABRIC <b>Remix 3</b>  |
| <b>TE</b>  | FABRIC <b>Uniform Melange</b>   |
| <b>SF</b>  | LEATHER <b>Fiore</b>  |
| <b>SV</b>  | LEATHER <b>Vintage</b>  |

### Optionals:

|              | Value                | Options/notes  |
|--------------|----------------------|--|
| <b>FM-M2</b> | Indoor matt metal M2 | + 57 €   |
|              |                      | ASH GREY <b>ES</b> , BLUE SAPPHIRE <b>EE</b> , BLUE TURQUOISE <b>EH</b> , BRONZE <b>E2</b> , BULGARO RED <b>FP</b> , CHERRY RED <b>EQ</b> , DARK GREEN <b>EL</b> , FACEPOWDER PINK <b>E8</b> , FANGO <b>E3</b> , GOLDEN YELLOW <b>EO</b> , LIGHT BLUE <b>EO</b> , LIGHT GREY <b>ET</b> , OCEAN BLUE <b>E1</b> , OCHER YELLOW <b>E7</b> , PAPAYA ORANGE <b>EA</b> , PASTEL YELLOW <b>E4</b> , PINE GREEN <b>EJ</b> , RED <b>ER</b> , SAGE GREEN <b>E9</b> |



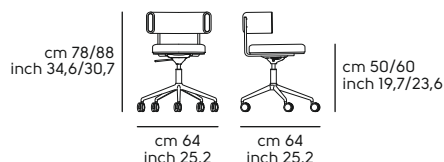

### Amelie DP



# Apelle design Beatriz Sempere

Apelle S, P, H65-75 - Shell in hide

Frame in: metal

| Model   | Code    | Mod. | Frame | Shell |       | Optional                | G.ty | boxes | Kg  | M <sup>3</sup> |
|---|---------|------|-------|-------|-------|-------------------------|------|-------|-----|----------------|
|   |         |      |       | CU    | CT    |                         |      |       |     |                |
| <b>Chair Apelle S M CU</b><br>     | S1000S0 | S    | M1    | 449 € | 673 € | FM-M2<br>FM-M3<br>FM-M4 | 2    | 1     | 13  | 0.41           |
| <b>Armchair APELLE P M CU</b><br>  | S1000P0 | P    | M1    | 499 € | 718 € | FM-M2<br>FM-M3<br>FM-M4 | 1    | 1     | 9   | 0.30           |
| <b>Stool APELLE H65 M CU</b><br>  | S1000H0 | H65  | M1    | 535 € | 746 € | FM-M2<br>FM-M3<br>FM-M4 | 1    | 1     | 8.5 | 0.29           |
| <b>Stool APELLE H75 M CU</b><br> | S1000J0 | H75  | M1    | 545 € | 756 € | FM-M2<br>FM-M3<br>FM-M4 | 1    | 1     | 9   | 0.31           |

**Frame finishes**

**Metal**

**M1** WHITE BB, INDUSTRIAL E5, BROWN E6, SAND EC, WHITE PEARL EF, GRAPHITE EG, BLACK EN

**Shell finishes**

**Upholstery**

**CU** HIDE

**CT** TUSCAN HIDE

**Optionals:**

|                                     | Value   | Options/notes   |
|-------------------------------------|---------|---|
| <b>FM-M2</b> Indoor matt metal M2   | + 62 €  | ASH GREY ES, BLUE SAPPHIRE EE, BLUE TURQUOISE EH, BRONZE E2, BULGARO RED FP, CHERRY RED EQ, DARK GREEN EL, FACEPOWDER PINK E8, FANGO E3, GOLDEN YELLOW EO, LIGHT BLUE E0, LIGHT GREY ET, OCEAN BLUE EI, OCHER YELLOW E7, PAPAYA ORANGE EA, PASTEL YELLOW E4, PINE GREEN EJ, RED ER, SAGE GREEN E9 |
| <b>FM-M3</b> Indoor glossy metal M3 | + 42 €  | CHROME CC   |
| <b>FM-M4</b> Indoor glossy Metal M4 | + 156 € | BLACK NICKEL DZ, CHAMPAGNE GOLD DG, GOLDEN BRONZE DB, MATT BLACK NICKEL DY, MATT GOLDEN BRONZE DC, PINK GOLD DR   |

**Apelle S**

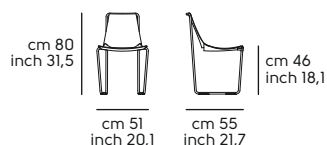

**Apelle P**

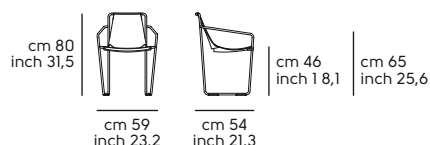

**Apelle H65**

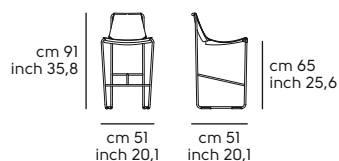



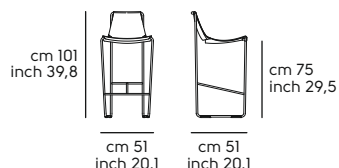



**Apelle H75**



## Apelle Jump H45-65-75 - Seat in hide, fabric or leather

Frame in: metal

| Model   | Code    | Mod. | Frame | Shell |  |  |  |       |  |  |  | Optional       | Q.ty | boxes | Kg | M³   |
|---|---------|------|-------|-------|--|--|--|-------|--|--|--|----------------|------|-------|----|------|
|   |         |      |       | CU    |  |  |  | CT    |  |  |  |                |      |       |    |      |
| <br><b>APELLE Jump H45 M CU</b> | S1000G1 | J45  | M1    | 252 € |  |  |  | 297 € |  |  |  | FM-M2<br>FM-M4 | 1    | 1     | 4  | 0.10 |
| <br><b>APELLE Jump H65 M CU</b> | S1000H1 | J65  | M1    | 286 € |  |  |  | 334 € |  |  |  | FM-M2<br>FM-M4 | 1    | 1     | 5  | 0.15 |
| <br><b>APELLE Jump H75 M CU</b> | S1000J1 | J75  | M1    | 308 € |  |  |  | 359 € |  |  |  | FM-M2<br>FM-M4 | 1    | 1     | 6  | 0.18 |

| Model   | Code    | Mod. | Frame | Shell |       |       |       |       |       |       |       |       | Optional       | Q.ty | boxes | Kg  | M³   |
|---|---------|------|-------|-------|-------|-------|-------|-------|-------|-------|-------|-------|----------------|------|-------|-----|------|
|   |         |      |       | TA    | TB    | TC    | TD    | TE    | SF    | SV    | COM   | COL   |                |      |       |     |      |
| <br><b>APELLE Jump H45 M TS</b> | S1000G1 | J45  | M1    | 213 € | 219 € | 230 € | 238 € | 285 € | 241 € | 263 € | 213 € | 230 € | FM-M2<br>FM-M4 | 1    | 1     | 5   | 0.10 |
| <br><b>APELLE Jump H65 M TS</b> | S1000H1 | J65  | M1    | 246 € | 252 € | 263 € | 271 € | 317 € | 275 € | 295 € | 246 € | 263 € | FM-M2<br>FM-M4 | 1    | 1     | 7   | 0.15 |
| <br><b>APELLE Jump H75 M TS</b> | S1000J1 | J75  | M1    | 258 € | 272 € | 285 € | 284 € | 331 € | 296 € | 319 € | 258 € | 285 € | FM-M2<br>FM-M4 | 1    | 1     | 7.5 | 0.18 |

**Frame finishes**

**Metal**



|           |  |
|-----------|--|
| <b>MI</b> | WHITE <b>BB</b> , INDUSTRIAL <b>E5</b> , BROWN <b>E6</b> , SAND <b>EC</b> , WHITE PEARL <b>EF</b> , GRAPHITE <b>EG</b> , BLACK <b>EN</b> |
|-----------|--|

**Seat finishes**

**Upholstery**

|           |   |           |  |
|-----------|---|-----------|--|
| <b>TA</b> | FAUX LEATHER <b>Secret</b> , FABRIC <b>Mirage</b> , FABRIC <b>Cotton Club</b> , FABRIC <b>Renewed Loop</b>  | <b>TB</b> | FAUX LEATHER <b>Vintage</b> , FABRIC <b>Fenix Wool</b> , FABRIC <b>Visual</b> , FABRIC <b>Manhattan</b> , FABRIC <b>Novabuk</b> , FABRIC <b>Network</b> , FABRIC <b>Gyre</b> |
| <b>TC</b> | VELVET SUPERB, FABRIC <b>Second</b> , FABRIC <b>Main Line Flax</b> , FABRIC <b>Oceanic</b> , FABRIC <b>Jumper</b> , FABRIC <b>Flame</b> , FABRIC <b>Ouche</b> , FABRIC <b>Plain</b> , FABRIC <b>Gemma</b> , FABRIC <b>Caltagirone 114</b> | <b>TD</b> | FABRIC <b>Yoredale</b> , FABRIC <b>Remix 3</b>   |
| <b>TE</b> | FABRIC <b>Uniform Melange</b>   | <b>SF</b> | LEATHER <b>Fiore</b>   |
| <b>SV</b> | LEATHER <b>Vintage</b>  | <b>CU</b> | HIDE   |
| <b>CT</b> | TUSCAN HIDE   |           |  |

**COM/COL - Minimum Q.ty 6 pc. for each material. For weft or patterned fabrics see specific pages**

|  |                        |  |               |
|--|------------------------|--|---------------|
|  <b>COM</b> | Mtl. 0.50 h. 1.40 Each |  <b>COL</b> | Mq. 0.40 Each |
|--|------------------------|--|---------------|

**Optionals:**

|              |                        | Value   | Options/notes  |
|--------------|------------------------|---------|--|
| <b>FM-M2</b> | Indoor matt metal M2   | + 62 €  | ASH GREY <b>ES</b> , BLUE SAPPHIRE <b>EE</b> , BLUE TURQUOISE <b>EH</b> , BRONZE <b>E2</b> , BULGARO RED <b>FP</b> , CHERRY RED <b>EQ</b> , DARK GREEN <b>EL</b> , FACEPOWDER PINK <b>E8</b> , FANGO <b>E3</b> , GOLDEN YELLOW <b>EO</b> , LIGHT BLUE <b>EO</b> , LIGHT GREY <b>ET</b> , OCEAN BLUE <b>E1</b> , OCHER YELLOW <b>E7</b> , PAPAYA ORANGE <b>EA</b> , PASTEL YELLOW <b>E4</b> , PINE GREEN <b>EJ</b> , RED <b>ER</b> , SAGE GREEN <b>E9</b> |
| <b>FM-M4</b> | Indoor glossy Metal M4 | + 156 € | BLACK NICKEL <b>DZ</b> , CHAMPAGNE GOLD <b>DG</b> , GOLDEN BRONZE <b>DB</b> , MATT BLACK NICKEL <b>DY</b> , MATT GOLDEN BRONZE <b>DC</b> , PINK GOLD <b>DR</b>   |

**Apelle J45**

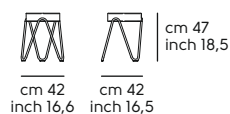

**Apelle J65**

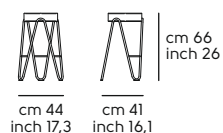

**Apelle J75**

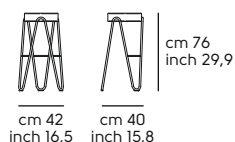

## Apelle Waiting Chair AT - Shell in hide

Frame in: metal

| Model  | Code    | Mod. | Frame | Shell |         | Optional                | Q.ty | boxes | Kg | M³   |
|--|---------|------|-------|-------|---------|-------------------------|------|-------|----|------|
|  |         |      |       | CU    | CT      |                         |      |       |    |      |
| <b>Waiting Chair APELLE AT M CU</b>  |         |      |       |       |         |                         |      |       |    |      |
|  | S1000AC | AT   | M1    | 778 € | 1.223 € | FM-M2<br>FM-M3<br>FM-M4 | 1    | 1     | 10 | 0.54 |

### Frame finishes

#### Metal

**M1** WHITE **BB**, INDUSTRIAL **E5**, BROWN **E6**, SAND **EC**, WHITE PEARL **EF**, GRAPHITE **EG**, BLACK **EN**

### Shell finishes

#### Upholstery

**CU** HIDE

**CT** TUSCAN HIDE

### Optionals:

|              |                        | Value   | Options/notes  |
|--------------|------------------------|---------|--|
| <b>FM-M2</b> | Indoor matt metal M2   | + 83 €  | ASH GREY <b>ES</b> , BLUE SAPPHIRE <b>EE</b> , BLUE TURQUOISE <b>EH</b> , BRONZE <b>E2</b> , BRONZE <b>EZ</b> + TRANSP., BULGARO RED <b>FP</b> , CHERRY RED <b>EQ</b> , DARK GREEN <b>EL</b> , FACEPOWDER PINK <b>E8</b> , FANGO <b>E3</b> , GOLDEN YELLOW <b>EO</b> , LIGHT BLUE <b>E0</b> , LIGHT GREY <b>ET</b> , OCEAN BLUE <b>EI</b> , OCHER YELLOW <b>E7</b> , PAPAYA ORANGE <b>EA</b> , PASTEL YELLOW <b>E4</b> , PINE GREEN <b>EJ</b> , RED <b>ER</b> , SAGE GREEN <b>E9</b> |
| <b>FM-M3</b> | Indoor glossy metal M3 | + 156 € | CHROME <b>CC</b>   |
| <b>FM-M4</b> | Indoor glossy Metal M4 | + 291 € | BLACK NICKEL <b>DZ</b> , CHAMPAGNE GOLD <b>DG</b> , GOLDEN BRONZE <b>DB</b> , MATT BLACK NICKEL <b>DY</b> , MATT GOLDEN BRONZE <b>DC</b> , PINK GOLD <b>DR</b>   |

### Apelle AT

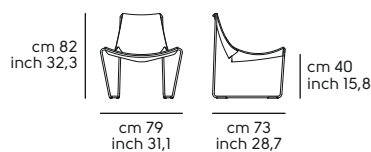

# Area design Studio Pastina



## Area - Seat and back in fabric

Frame in: metal

| Model  | Code    | Mod. | Frame | Seat and Backrest |       |       |       |         |         |         |       | Optional | G.ty                   | boxes | Kg | M <sup>2</sup> |      |
|--|---------|------|-------|-------------------|-------|-------|-------|---------|---------|---------|-------|----------|------------------------|-------|----|----------------|------|
|  |         |      |       | TA                | TB    | TC    | TD    | TE      | SF      | SV      | COM   |          |                        |       |    |                | COL  |
| <br>Pouf AREA B1 M TS | S2090B1 | B1   | M1    | 735 €             | 770 € | 856 € | 917 € | 1.043 € | 1.102 € | 1.250 € | 856 € | 856 €    | FM-M2<br>ES-1<br>PD-FO | 1     | 1  | 15             | 0.35 |
|  |         |      |       |                   |       |       |       |         |         |         |       |          |                        |       |    |                |      |

### Note:

For COM. Min. Qty 5 Pc.

|   |                        |   |               |
|---|------------------------|---|---------------|
|  COM | Mtl. 1.56 h. 1.40 Each |  COL | Mq. 2.80 Each |
|---|------------------------|---|---------------|



### Optionals:

|      | Value          | Options/notes |
|------|----------------|---------------|
| ES-1 | Fireproof foam | + 98 € ES-1   |

| Model  | Code    | Mod. | Frame | Seat and Backrest |         |         |         |         |         |         |         | Optional | G.ty                   | boxes | Kg | M <sup>2</sup> |       |
|--|---------|------|-------|-------------------|---------|---------|---------|---------|---------|---------|---------|----------|------------------------|-------|----|----------------|-------|
|  |         |      |       | TA                | TB      | TC      | TD      | TE      | SF      | SV      | COM     |          |                        |       |    |                | COL   |
| <br>Pouf AREA B2 M TS | S2090B2 | B2   | M1    | 980 €             | 1.039 € | 1.182 € | 1.286 € | 1.478 € | 1.643 € | 1.880 € | 1.182 € | 1.182 €  | FM-M2<br>ES-1<br>PD-FO | 1     | 1  | 27             | 0.657 |
|  |         |      |       |                   |         |         |         |         |         |         |         |          |                        |       |    |                |       |

### Note:

For COM. Min. Qty 5 Pc.

|   |                        |   |               |
|---|------------------------|---|---------------|
|  COM | Mtl. 2.58 h. 1.40 Each |  COL | Mq. 4.40 Each |
|---|------------------------|---|---------------|



### Optionals:

|      | Value          | Options/notes |
|------|----------------|---------------|
| ES-1 | Fireproof foam | + 147 € ES-1  |

| Model   | Code       | Mod. | Frame | Seat and Backrest |         |         |         |         |         |         |         | Optional | G.ty                   | boxes | Kg | M <sup>2</sup> |       |
|---|------------|------|-------|-------------------|---------|---------|---------|---------|---------|---------|---------|----------|------------------------|-------|----|----------------|-------|
|   |            |      |       | TA                | TB      | TC      | TD      | TE      | SF      | SV      | COM     |          |                        |       |    |                | COL   |
| <br>Armchair AREA P M TS | S2090DVI00 | P    | M1    | 995 €             | 1.107 € | 1.260 € | 1.371 € | 1.590 € | 1.690 € | 1.959 € | 1.260 € | 1.260 €  | FM-M2<br>ES-1<br>PD-FO | 1     | 1  | 22             | 0.477 |
|   |            |      |       |                   |         |         |         |         |         |         |         |          |                        |       |    |                |       |

### Note:



For COM. Min. Qty 5 Pc.

|   |                        |   |               |
|---|------------------------|---|---------------|
|  COM | Mtl. 2.76 h. 1.40 Each |  COL | Mq. 5.00 Each |
|---|------------------------|---|---------------|

| Optionals:  |                | Value   | Options/notes |
|-------------|----------------|---------|---------------|
| <b>ES-1</b> | Fireproof foam | + 147 € | ES-1          |

| Model   | Code       | Mod. | Frame | Seat and Backrest |         |         |         |         |         |         |         |         | Optional               | Q.ty | boxes | Kg | M³    |
|---|------------|------|-------|-------------------|---------|---------|---------|---------|---------|---------|---------|---------|------------------------|------|-------|----|-------|
|   |            |      |       | TA                | TB      | TC      | TD      | TE      | SF      | SV      | COM     | COL     |                        |      |       |    |       |
|  <b>Armchair AREA P_BR M TS</b> | S2090DVIB2 | P BR | MI    | 1.811 €           | 1.914 € | 2.170 € | 2.356 € | 2.723 € | 2.790 € | 3.287 € | 2.170 € | 2.170 € | FM-M2<br>ES-1<br>PD-FO | 1    | 1     | 30 | 0.562 |

**Note:**  
For COM. Min. Qty 5 Pc.

|   |                        |  |               |
|---|------------------------|--|---------------|
|  <b>COM</b> | Mtl. 4.63 h. 1.40 Each |  <b>COL</b> | Mq. 8.60 Each |
|---|------------------------|--|---------------|

| Optionals:  |                | Value   | Options/notes |
|-------------|----------------|---------|---------------|
| <b>ES-1</b> | Fireproof foam | + 198 € | ES-1          |

| Model  | Code       | Mod. | Frame | Seat and Backrest |         |         |         |         |         |         |         |         | Optional               | Q.ty | boxes | Kg | M³    |
|--|------------|------|-------|-------------------|---------|---------|---------|---------|---------|---------|---------|---------|------------------------|------|-------|----|-------|
|  |            |      |       | TA                | TB      | TC      | TD      | TE      | SF      | SV      | COM     | COL     |                        |      |       |    |       |
|  <b>Sofa AREA DV2 M TS</b> | S2090DV200 | DV2  | MI    | 1.688 €           | 1.796 € | 2.064 € | 2.259 € | 2.617 € | 2.675 € | 3.230 € | 2.064 € | 2.064 € | FM-M2<br>ES-1<br>PD-FO | 1    | 1     | 38 | 0.894 |

**Note:**  
For COM. Min. Qty 5 Pc.

|   |                        |  |               |
|---|------------------------|--|---------------|
|  <b>COM</b> | Mtl. 4.72 h. 1.40 Each |  <b>COL</b> | Mq. 8.10 Each |
|---|------------------------|--|---------------|

| Optionals:  |                | Value   | Options/notes |
|-------------|----------------|---------|---------------|
| <b>ES-1</b> | Fireproof foam | + 222 € | ES-1          |

| Model  | Code       | Mod.       | Frame | Seat and Backrest |         |         |         |         |         |         |         |         | Optional               | Q.ty | boxes | Kg | M³    |
|--|------------|------------|-------|-------------------|---------|---------|---------|---------|---------|---------|---------|---------|------------------------|------|-------|----|-------|
|  |            |            |       | TA                | TB      | TC      | TD      | TE      | SF      | SV      | COM     | COL     |                        |      |       |    |       |
|  <b>Dormeuse AREA DV2_DRM M TS</b> | S2090DV2BI | DV2<br>DRM | MI    | 2.016 €           | 2.124 € | 2.392 € | 2.586 € | 2.944 € | 2.998 € | 3.323 € | 2.392 € | 2.392 € | FM-M2<br>ES-1<br>PD-FO | 1    | 1     | 40 | 0.937 |

**Note:**  
For COM. Min. Qty 5 Pc.

|   |                        |  |               |
|---|------------------------|--|---------------|
|  <b>COM</b> | Mtl. 4.72 h. 1.40 Each |  <b>COL</b> | Mq. 8.40 Each |
|---|------------------------|--|---------------|

| Optionals:  |                |         |               |
|-------------|----------------|---------|---------------|
|             |                | Value   | Options/notes |
| <b>ES-1</b> | Fireproof foam | + 233 € | ES-1          |

| Model  | Code       | Mod.   | Frame | Seat and Backrest |         |         |         |         |         |         |         |         | Optional               | Q.ty | boxes | Kg | M³    |
|--|------------|--------|-------|-------------------|---------|---------|---------|---------|---------|---------|---------|---------|------------------------|------|-------|----|-------|
|  |            |        |       | TA                | TB      | TC      | TD      | TE      | SF      | SV      | COM     | COL     |                        |      |       |    |       |
|  <b>Sofa AREA DV2_BR M TS</b> | S2090DV2B2 | DV2 BR | MI    | 2.451 €           | 2.601 € | 2.976 € | 3.246 € | 3.743 € | 3.878 € | 4.468 € | 2.976 € | 2.976 € | FM-M2<br>ES-1<br>PD-FO | 1    | 1     | 46 | 0.991 |

**Note:**  
For COM. Min. Qty 5 Pc.

|  |                        |  |                |
|--|------------------------|--|----------------|
|  <b>COM</b> | Mtl. 6.55 h. 1.40 Each |  <b>COL</b> | Mq. 11.70 Each |
|--|------------------------|--|----------------|

| Optionals:  |                |         |               |
|-------------|----------------|---------|---------------|
|             |                | Value   | Options/notes |
| <b>ES-1</b> | Fireproof foam | + 294 € | ES-1          |

| Model   | Code       | Mod. | Frame | Seat and Backrest |         |         |         |         |         |         |         |         | Optional               | Q.ty | boxes | Kg | M³    |
|---|------------|------|-------|-------------------|---------|---------|---------|---------|---------|---------|---------|---------|------------------------|------|-------|----|-------|
|   |            |      |       | TA                | TB      | TC      | TD      | TE      | SF      | SV      | COM     | COL     |                        |      |       |    |       |
|  <b>Sofa AREA DV3 M TS</b> | S2090DV300 | DV3  | MI    | 2.612 €           | 2.758 € | 3.126 € | 3.392 € | 3.903 € | 4.028 € | 4.619 € | 3.126 € | 3.126 € | FM-M2<br>ES-1<br>PD-FO | 1    | 1     | 64 | 1.296 |

**Note:**  
For COM. Min. Qty 5 Pc.

|  |                        |  |                |
|--|------------------------|--|----------------|
|  <b>COM</b> | Mtl. 6.54 h. 1.40 Each |  <b>COL</b> | Mq. 11.10 Each |
|--|------------------------|--|----------------|

| Optionals:  |                |         |               |
|-------------|----------------|---------|---------------|
|             |                | Value   | Options/notes |
| <b>ES-1</b> | Fireproof foam | + 392 € | ES-1          |

| Model  | Code       | Mod.   | Frame | Seat and Backrest |         |         |         |         |         |         |         |         | Optional               | Q.ty | boxes | Kg | M³    |
|--|------------|--------|-------|-------------------|---------|---------|---------|---------|---------|---------|---------|---------|------------------------|------|-------|----|-------|
|  |            |        |       | TA                | TB      | TC      | TD      | TE      | SF      | SV      | COM     | COL     |                        |      |       |    |       |
|  <b>Sofa AREA DV3_BR M TS</b> | S2090DV3B2 | DV3 BR | MI    | 3.377 €           | 3.565 € | 4.037 € | 4.377 € | 5.032 € | 5.163 € | 5.927 € | 4.037 € | 4.037 € | FM-M2<br>ES-1<br>PD-FO | 1    | 1     | 72 | 1.403 |

**Note:**  
For COM. Min. Qty 5 Pc.

|  |                        |  |                |
|--|------------------------|--|----------------|
|  <b>COM</b> | Mtl. 8.40 h. 1.40 Each |  <b>COL</b> | Mq. 14.70 Each |
|--|------------------------|--|----------------|

| Optionals:  |                |         |               |
|-------------|----------------|---------|---------------|
|             |                | Value   | Options/notes |
| <b>ES-1</b> | Fireproof foam | + 478 € | ES-1          |

**Frame finishes**

| Metal     |   |
|-----------|---|
| <b>MI</b> | WHITE <b>BB</b> , BROWN <b>E6</b> , SAND <b>EC</b> , WHITE PEARL <b>EF</b> , GRAPHITE <b>EG</b> , BLACK <b>EN</b> |

**Seat and Back finishes**

| Upholstery |   |           |  |
|------------|---|-----------|--|
| <b>TA</b>  | FAUX LEATHER <b>Secret</b> , FABRIC <b>Mirage</b> , FABRIC <b>Cotton Club</b> , FABRIC <b>Renewed Loop</b>  | <b>TB</b> | FAUX LEATHER <b>Vintage</b> , FABRIC <b>Fenix Wool</b> , FABRIC <b>Visual</b> , FABRIC <b>Manhattan</b> , FABRIC <b>Novabuk</b> , FABRIC <b>Network</b> , FABRIC <b>Gyre</b> |
| <b>TC</b>  | VELVET <b>SUPERB</b> , FABRIC <b>Second</b> , FABRIC <b>Main Line Flax</b> , FABRIC <b>Oceanic</b> , FABRIC <b>Jumper</b> , FABRIC <b>Flame</b> , FABRIC <b>Ouche</b> , FABRIC <b>Plain</b> , FABRIC <b>Gemma</b> , FABRIC <b>Callagirone 114</b> | <b>TD</b> | FABRIC <b>Yoredate</b> , FABRIC <b>Remix 3</b>   |
| <b>TE</b>  | FABRIC <b>Uniform Melange</b>   | <b>SF</b> | LEATHER <b>Fiore</b>   |
| <b>SV</b>  | LEATHER <b>Vintage</b>  |           |  |

| Optionals:   |                      |        |  |
|--------------|----------------------|--------|--|
|              |                      | Value  | Options/notes  |
| <b>FM-M2</b> | Indoor matt metal M2 | + 58 € | ASH GREY <b>ES</b> , BLUE SAPPHIRE <b>EE</b> , BLUE TURQUOISE <b>EH</b> , BRONZE <b>E2</b> , BULGARO RED <b>FP</b> , CHERRY RED <b>EQ</b> , DARK GREEN <b>EL</b> , FACEPOWDER PINK <b>E8</b> , FANGO <b>E3</b> , GOLDEN YELLOW <b>EO</b> , LIGHT BLUE <b>EO</b> , LIGHT GREY <b>ET</b> , OCEAN BLUE <b>E1</b> , OCHER YELLOW <b>E7</b> , PAPAYA ORANGE <b>EA</b> , PASTEL YELLOW <b>E4</b> , PINE GREEN <b>EJ</b> , RED <b>ER</b> , SAGE GREEN <b>EN</b> |
| <b>PD-F0</b> | Felt pad feet        | + 6 €  | PD-F0  |

**Area B1**

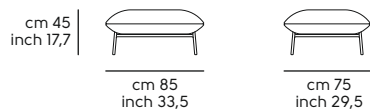

**Area B2**

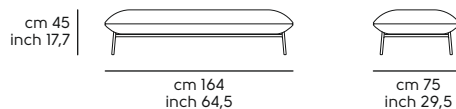

**Area P**

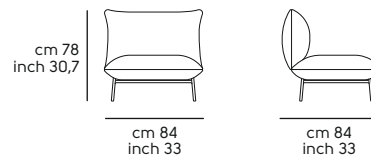

**Area P BR**

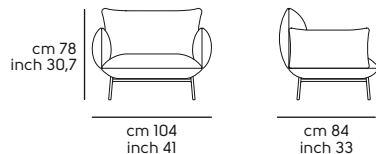

**Area DV2**

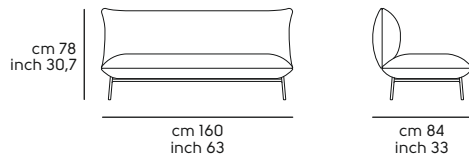

**Area DV2 DRM**

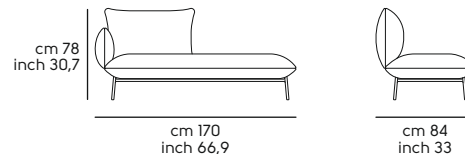

**Area DV2 BR**

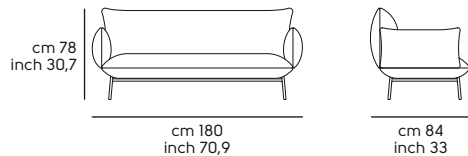

**Area DV3**

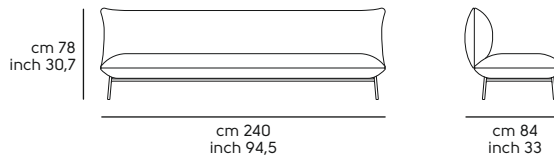

**Area DV3 BR**

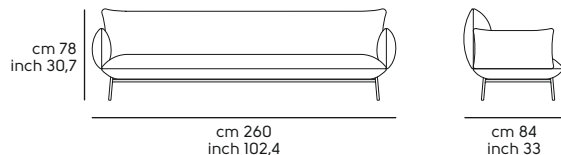

# Bolle design Paola Navone

## Bolle INDOOR - P, AP, DV - Seat and cushion in fabric

Frame in: metal

| Model  | Code    | Mod. | Frame and Backrest | Seat and cushions |       |       |       |         |       | Optional               | Q.ty | boxes | Kg   | M <sup>3</sup> |
|--|---------|------|--------------------|-------------------|-------|-------|-------|---------|-------|------------------------|------|-------|------|----------------|
|  |         |      |                    | TA                | TB    | TC    | TD    | TE      | COM   |                        |      |       |      |                |
| <br><b>Armchair BOLLE P M TS IN</b> | S2200PT | P    | MI                 | 768 €             | 803 € | 853 € | 890 € | 1.010 € | 768 € | FM-M2<br>ES-1<br>PD-F0 | 1    | 1     | 11.5 | 0.29           |

**Note:**

CUSHION INCLUDED - 1 SMALL

**COM/COL - Minimum Q.ty 6 pc. for each material. For weft or patterned fabrics see specific pages**

|   |                                  |
|---|----------------------------------|
|  | Mtl. 0.68 h. 1.40 Each ONLY SEAT |
|---|----------------------------------|

**Optionals:**

|              |                      | Value  | Options/notes  |
|--------------|----------------------|--------|--|
| <b>FM-M2</b> | Indoor matt metal M2 | + 67 € | ASH GREY <b>ES</b> , BLUE SAPPHIRE <b>EE</b> , BLUE TURQUOISE <b>EH</b> , BRONZE <b>E2</b> , BULGARO RED <b>FP</b> , CHERRY RED <b>EQ</b> , DARK GREEN <b>EL</b> , FACEPOWDER PINK <b>E8</b> , FANGO <b>E3</b> , GOLDEN YELLOW <b>EO</b> , LIGHT BLUE <b>EO</b> , LIGHT GREY <b>ET</b> , OCEAN BLUE <b>E1</b> , OCHER YELLOW <b>E7</b> , PAPAYA ORANGE <b>EA</b> , PASTEL YELLOW <b>E4</b> , PINE GREEN <b>EJ</b> , RED <b>ER</b> , SAGE GREEN <b>E9</b> |
| <b>ES-1</b>  | Fireproof foam       | + 22 € | ES-1   |
| <b>PD-F0</b> | Felt pad feet        | + 6 €  | PD-F0  |

| Model  | Code    | Mod. | Frame and Backrest | Seat and cushions |         |         |         |         |         | Optional               | Q.ty | boxes | Kg | M <sup>3</sup> |
|--|---------|------|--------------------|-------------------|---------|---------|---------|---------|---------|------------------------|------|-------|----|----------------|
|  |         |      |                    | TA                | TB      | TC      | TD      | TE      | COM     |                        |      |       |    |                |
| <br><b>Waiting Chair BOLLE AP M TS IN</b> | S2200AT | AP   | MI                 | 1.311 €           | 1.395 € | 1.530 € | 1.620 € | 1.874 € | 1.311 € | FM-M2<br>ES-1<br>PD-F0 | 1    | 1     | 20 | 0.50           |

**Note:**

CUSHIONS INCLUDED - 1 SMALL + 1 BIG

**COM/COL - Minimum Q.ty 6 pc. for each material. For weft or patterned fabrics see specific pages**

|   |                                  |
|---|----------------------------------|
|  | Mtl. 1.21 h. 1.40 Each ONLY SEAT |
|---|----------------------------------|

**Optionals:**

|              |                      | Value  | Options/notes  |
|--------------|----------------------|--------|--|
| <b>FM-M2</b> | Indoor matt metal M2 | + 88 € | ASH GREY <b>ES</b> , BLUE SAPPHIRE <b>EE</b> , BLUE TURQUOISE <b>EH</b> , BRONZE <b>E2</b> , BULGARO RED <b>FP</b> , CHERRY RED <b>EQ</b> , DARK GREEN <b>EL</b> , FACEPOWDER PINK <b>E8</b> , FANGO <b>E3</b> , GOLDEN YELLOW <b>EO</b> , LIGHT BLUE <b>EO</b> , LIGHT GREY <b>ET</b> , OCEAN BLUE <b>E1</b> , OCHER YELLOW <b>E7</b> , PAPAYA ORANGE <b>EA</b> , PASTEL YELLOW <b>E4</b> , PINE GREEN <b>EJ</b> , RED <b>ER</b> , SAGE GREEN <b>E9</b> |
| <b>ES-1</b>  | Fireproof foam       | + 33 € | ES-1   |
| <b>PD-F0</b> | Felt pad feet        | + 6 €  | PD-F0  |

| Model   | Code    | Mod. | Frame and Backrest | Seat and cushions |         |         |         |         |         | Optional               | Q.ty | boxes | Kg | M³   |
|---|---------|------|--------------------|-------------------|---------|---------|---------|---------|---------|------------------------|------|-------|----|------|
|   |         |      |                    | TA                | TB      | TC      | TD      | TE      | COM     |                        |      |       |    |      |
|  Sofa <b>BOLLE DV M TS IN</b> | S2200LT | DV   | MI                 | 2.649 €           | 2.854 € | 3.188 € | 3.404 € | 4.017 € | 2.649 € | FM-M2<br>ES-1<br>PD-F0 | 1    | 1     | 37 | 0.88 |

**Note:**  
CUSHIONS INCLUDED - 2 SMALL + 2 MEDIUM + 2 BIG

**COM/COL - Minimum Q.ty 6 pc. for each material. For weft or patterned fabrics see specific pages**

|   |
|---|
|  Mtl. 2.02 h. 1.40 Each ONLY SEAT |
|---|

**Optionals:**

|              |                      | Value   | Options/notes  |
|--------------|----------------------|---------|--|
| <b>FM-M2</b> | Indoor matt metal M2 | + 173 € | ASH GREY <b>ES</b> , BLUE SAPPHIRE <b>EE</b> , BLUE TURQUOISE <b>EH</b> , BRONZE <b>E2</b> , BULGARO RED <b>FP</b> , CHERRY RED <b>EQ</b> , DARK GREEN <b>EL</b> , FACEPOWDER PINK <b>E8</b> , FANGO <b>E3</b> , GOLDEN YELLOW <b>EO</b> , LIGHT BLUE <b>EO</b> , LIGHT GREY <b>ET</b> , OCEAN BLUE <b>EI</b> , OCHER YELLOW <b>E7</b> , PAPAYA ORANGE <b>EA</b> , PASTEL YELLOW <b>E4</b> , PINE GREEN <b>EJ</b> , RED <b>ER</b> , SAGE GREEN <b>E9</b> |
| <b>ES-1</b>  | Fireproof foam       | + 65 €  | ES-1   |
| <b>PD-F0</b> | Felt pad feet        | + 6 €   | PD-F0  |

**Note:**  
--

**Frame and Back finishes**

**Metal**

|           |   |
|-----------|---|
| <b>MI</b> | WHITE <b>BB</b> , BROWN <b>E6</b> , SAND <b>EC</b> , WHITE PEARL <b>EF</b> , GRAPHITE <b>EG</b> , BLACK <b>EN</b> |
|-----------|---|



**Finishes Seat and Cushions**

**Upholstery**

|           |   |           |  |
|-----------|---|-----------|--|
| <b>TA</b> | FAUX LEATHER <b>Secret</b> , FABRIC <b>Mirage</b> , FABRIC <b>Cotton Club</b> , FABRIC <b>Renewed Loop</b>  | <b>TB</b> | FAUX LEATHER <b>Vintage</b> , FABRIC <b>Fenix Wool</b> , FABRIC <b>Visual</b> , FABRIC <b>Manhattan</b> , FABRIC <b>Novabuk</b> , FABRIC <b>Network</b> , FABRIC <b>Gyre</b> |
| <b>TC</b> | VELVET SUPERB, FABRIC <b>Second</b> , FABRIC <b>Main Line Flax</b> , FABRIC <b>Oceanic</b> , FABRIC <b>Jumper</b> , FABRIC <b>Flame</b> , FABRIC <b>Ouche</b> , FABRIC <b>Plain</b> , FABRIC <b>Gemma</b> , FABRIC <b>Caltagirone 114</b> | <b>TD</b> | FABRIC <b>Yoredale</b> , FABRIC <b>Remix 3</b>   |
| <b>TE</b> | FABRIC <b>Uniform Melange</b>   |           |  |

**Bolle INOX OUTDOOR - P, AP, DV - Seat and cushion in fabric**

Frame with bases in: Inox and shell in alluminium

| Model   | Code    | Mod. | Frame and Backrest | Seat and cushions |         | Optional               | Q.ty | boxes | Kg   | M³   |
|---|---------|------|--------------------|-------------------|---------|------------------------|------|-------|------|------|
|   |         |      |                    | TC                | COM     |                        |      |       |      |      |
| <b>Armchair BOLLE P M TS OUT</b><br>  | S220IPT | P    | M1                 | 1.460 €           | 1.460 € | FM-M2<br>FM-M2<br>ES-1 | 1    | 1     | 11.5 | 0.29 |



**Note:**  
CUSHION INCLUDED - 1 SMALL

**COM/COL - Minimum Q.ty 6 pc. for each material. For weft or patterned fabrics see specific pages**

|   |                                  |
|---|----------------------------------|
|  | Mtl. 0.68 h. 1.40 Each ONLY SEAT |
|---|----------------------------------|

**Optionals:**

|              |                      | Value  | Options/notes  |
|--------------|----------------------|--------|--|
| <b>FM-M2</b> | Indoor matt metal M2 | + 65 € | ASH GREY <b>ES</b> , BLUE SAPPHIRE <b>EE</b> , BLUE TURQUOISE <b>EH</b> , BRONZE <b>E2</b> , BULGARO RED <b>FP</b> , CHERRY RED <b>EQ</b> , DARK GREEN <b>EL</b> , FACEPOWDER PINK <b>E8</b> , FANGO <b>E3</b> , GOLDEN YELLOW <b>EO</b> , LIGHT BLUE <b>EO</b> , LIGHT GREY <b>ET</b> , OCEAN BLUE <b>E1</b> , OCHER YELLOW <b>E7</b> , PAPAYA ORANGE <b>EA</b> , PASTEL YELLOW <b>E4</b> , PINE GREEN <b>EJ</b> , RED <b>ER</b> , SAGE GREEN <b>E9</b> |
| <b>ES-1</b>  | Fireproof foam       | + 28 € | ES-1   |

| Model   | Code    | Mod. | Frame and Backrest | Seat and cushions |         | Optional               | Q.ty | boxes | Kg | M³   |
|---|---------|------|--------------------|-------------------|---------|------------------------|------|-------|----|------|
|   |         |      |                    | TC                | COM     |                        |      |       |    |      |
| <b>Waiting Chair BOLLE AP M TS OUT</b><br>  | S220IAT | AP   | M1                 | 2.141 €           | 2.141 € | FM-M2<br>FM-M2<br>ES-1 | 1    | 1     | 20 | 0.50 |



**Note:**  
CUSHIONS INCLUDED - 1 SMALL + 1 BIG

**COM/COL - Minimum Q.ty 6 pc. for each material. For weft or patterned fabrics see specific pages**

|   |                                  |
|---|----------------------------------|
|  | Mtl. 1.21 h. 1.40 Each ONLY SEAT |
|---|----------------------------------|

**Optionals:**

|              |                      | Value  | Options/notes  |
|--------------|----------------------|--------|--|
| <b>FM-M2</b> | Indoor matt metal M2 | + 87 € | ASH GREY <b>ES</b> , BLUE SAPPHIRE <b>EE</b> , BLUE TURQUOISE <b>EH</b> , BRONZE <b>E2</b> , BULGARO RED <b>FP</b> , CHERRY RED <b>EQ</b> , DARK GREEN <b>EL</b> , FACEPOWDER PINK <b>E8</b> , FANGO <b>E3</b> , GOLDEN YELLOW <b>EO</b> , LIGHT BLUE <b>EO</b> , LIGHT GREY <b>ET</b> , OCEAN BLUE <b>E1</b> , OCHER YELLOW <b>E7</b> , PAPAYA ORANGE <b>EA</b> , PASTEL YELLOW <b>E4</b> , PINE GREEN <b>EJ</b> , RED <b>ER</b> , SAGE GREEN <b>E9</b> |
| <b>ES-1</b>  | Fireproof foam       | + 38 € | ES-1   |

| Model   | Code    | Mod. | Frame and Backrest | Seat and cushions |         | Optional               | Q.ty | boxes | Kg | M <sup>3</sup> |
|---|---------|------|--------------------|-------------------|---------|------------------------|------|-------|----|----------------|
| <br> | S2201LT | DV   | M1                 | TC                | COM     | FM-M2<br>FM-M2<br>ES-1 | 1    | 1     | 37 | 0.88           |
|   |         |      |                    | 4.087 €           | 4.087 € |                        |      |       |    |                |

**Note:**  
CUSHIONS INCLUDED - 2 SMALL + 2 MEDIUM + 2 BIG

**COM/COL - Minimum Q.ty 6 pc. for each material. For weft or patterned fabrics see specific pages**

|  |                                  |
|--|----------------------------------|
|  | Mtl. 2.02 h. 1.40 Each ONLY SEAT |
|--|----------------------------------|

**Optionals:**

|              | Value   | Options/notes  |
|--------------|---------|--|
| <b>FM-M2</b> | + 173 € | Indoor matt metal M2<br>ASH GREY <b>ES</b> , BLUE SAPPHIRE <b>EE</b> , BLUE TURQUOISE <b>EH</b> , BRONZE <b>E2</b> , BULGARO RED <b>FP</b> , CHERRY RED <b>EQ</b> , DARK GREEN <b>EL</b> , FACEPOWDER PINK <b>E8</b> , FANGO <b>E3</b> , GOLDEN YELLOW <b>EO</b> , LIGHT BLUE <b>EO</b> , LIGHT GREY <b>ET</b> , OCEAN BLUE <b>EI</b> , OCHER YELLOW <b>E7</b> , PAPAYA ORANGE <b>EA</b> , PASTEL YELLOW <b>E4</b> , PINE GREEN <b>EJ</b> , RED <b>ER</b> , SAGE GREEN <b>E9</b> |
| <b>ES-1</b>  | + 70 €  | Fireproof foam<br>ES-1   |

**Note:**  
--

**Frame and Back finishes**

|              |   |
|--------------|---|
| <b>Metal</b> |   |
| <b>M1</b>    | WHITE <b>BB</b> , BROWN <b>E6</b> , SAND <b>EC</b> , WHITE PEARL <b>EF</b> , GRAPHITE <b>EG</b> , BLACK <b>EN</b> |

**Finishes Seat and Cushions**

|                   |   |
|-------------------|---|
| <b>Upholstery</b> |   |
| <b>TC</b>         | FABRIC <b>Flame</b> , FABRIC <b>Ouche</b> , FABRIC <b>Plain</b> |

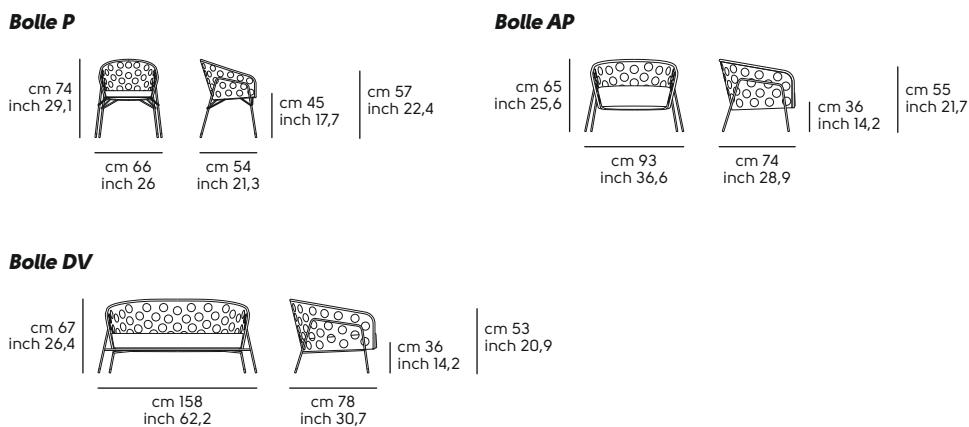

**Bolle INDOOR Cushion - Cushion in fabric**

--

| Model   | Code    | Mod. | -- | Upholstery |       |       |       |       |       | Optional | Q.ty | boxes | Kg  | M <sup>3</sup> |
|---|---------|------|----|------------|-------|-------|-------|-------|-------|----------|------|-------|-----|----------------|
|   |         |      |    | TA         | TB    | TC    | TD    | TE    | COM   |          |      |       |     |                |
|  <b>Cushion BOLLE Small IN</b> | A2200Q0 | S    |    | 101 €      | 116 € | 142 € | 160 € | 219 € | 101 € | ES-1     | 1    | 1     | 0.9 | 0.01           |

**COM/COL - Minimum Q.ty 6 pc. for each material. For weft or patterned fabrics see specific pages**

|  |                        |
|--|------------------------|
|  <b>COM</b> | Mtl. 0.63 h. 1.40 Each |
|--|------------------------|

| Model  | Code    | Mod. | -- | Upholstery |       |       |       |       |       | Optional | Q.ty | boxes | Kg  | M <sup>3</sup> |
|--|---------|------|----|------------|-------|-------|-------|-------|-------|----------|------|-------|-----|----------------|
|  |         |      |    | TA         | TB    | TC    | TD    | TE    | COM   |          |      |       |     |                |
|  <b>Cushion BOLLE Medium IN</b> | A2200Q1 | M    |    | 124 €      | 143 € | 170 € | 192 € | 249 € | 124 € | ES-1     | 1    | 1     | 1.1 | 0.04           |

**COM/COL - Minimum Q.ty 6 pc. for each material. For weft or patterned fabrics see specific pages**

|  |                        |
|--|------------------------|
|  <b>COM</b> | Mtl. 0.73 h. 1.40 Each |
|--|------------------------|

| Model   | Code    | Mod. | -- | Upholstery |       |       |       |       |       | Optional | Q.ty | boxes | Kg | M <sup>3</sup> |
|---|---------|------|----|------------|-------|-------|-------|-------|-------|----------|------|-------|----|----------------|
|   |         |      |    | TA         | TB    | TC    | TD    | TE    | COM   |          |      |       |    |                |
|  <b>Cushion BOLLE Large IN</b> | A2200Q2 | L    |    | 200 €      | 223 € | 263 € | 289 € | 360 € | 200 € | ES-1     | 1    | 1     | 2  | 0.09           |

**COM/COL - Minimum Q.ty 6 pc. for each material. For weft or patterned fabrics see specific pages**

|  |                        |
|--|------------------------|
|  <b>COM</b> | Mtl. 1.00 h. 1.40 Each |
|--|------------------------|

**Cushion finishes**

**Upholstery**



|           |   |           |  |
|-----------|---|-----------|--|
| <b>TA</b> | FAUX LEATHER <b>Secret</b> , FABRIC <b>Mirage</b> , FABRIC <b>Cotton Club</b> , FABRIC <b>Renewed Loop</b>  | <b>TB</b> | FAUX LEATHER <b>Vintage</b> , FABRIC <b>Fenix Wool</b> , FABRIC <b>Visual</b> , FABRIC <b>Manhattan</b> , FABRIC <b>Novabuk</b> , FABRIC <b>Network</b> , FABRIC <b>Gyre</b> |
| <b>TC</b> | VELVET SUPERB, FABRIC <b>Second</b> , FABRIC <b>Main Line Flax</b> , FABRIC <b>Oceanic</b> , FABRIC <b>Jumper</b> , FABRIC <b>Flame</b> , FABRIC <b>Ouche</b> , FABRIC <b>Plain</b> , FABRIC <b>Gemma</b> , FABRIC <b>Caltagirone 114</b> | <b>TD</b> | FABRIC <b>Yoredale</b> , FABRIC <b>Remix 3</b>   |
| <b>TE</b> | FABRIC <b>Uniform Melange</b>   |           |  |

**Optionals:**

|             | Value          | Options/notes |
|-------------|----------------|---------------|
| <b>ES-1</b> | Fireproof foam | + 11 € ES-1   |



## Bolle OUTDOOR Cushion - Cushion in fabric

--

| Model   | Code  | Mod. | -- | Upholstery |       | Optional | Q.ty | boxes | Kg  | M³   |
|---|---|------|----|------------|-------|----------|------|-------|-----|------|
|   |   |      |    | TC         | COM   |          |      |       |     |      |
| <b>Cushion BOLLE Small OUT</b>  |   |      |    |            |       |          |      |       |     |      |
|  | A2201Q0   | S    |    | 163 €      | 163 € | ES-1     | 1    | 1     | 0.9 | 0.01 |
|   |  |      |    |            |       |          |      |       |     |      |



COM/COL - Minimum Q.ty 6 pc. for each material. For weft or patterned fabrics see specific pages

|  |                        |
|--|------------------------|
|  | Mtl. 0.63 h. 1.40 Each |
|--|------------------------|

| Model  | Code  | Mod. | -- | Upholstery |       | Optional | Q.ty | boxes | Kg  | M³   |
|--|---|------|----|------------|-------|----------|------|-------|-----|------|
|  |   |      |    | TC         | COM   |          |      |       |     |      |
| <b>Cushion BOLLE Medium OUT</b>  |   |      |    |            |       |          |      |       |     |      |
|  | A2201Q1   | M    |    | 203 €      | 203 € | ES-1     | 1    | 1     | 1.1 | 0.04 |
|  |  |      |    |            |       |          |      |       |     |      |

COM/COL - Minimum Q.ty 6 pc. for each material. For weft or patterned fabrics see specific pages

|  |                        |
|--|------------------------|
|  | Mtl. 0.73 h. 1.40 Each |
|--|------------------------|

| Model  | Code  | Mod. | -- | Upholstery |       | Optional | Q.ty | boxes | Kg | M³   |
|--|---|------|----|------------|-------|----------|------|-------|----|------|
|  |   |      |    | TC         | COM   |          |      |       |    |      |
| <b>Cushion BOLLE Large OUT</b>   |   |      |    |            |       |          |      |       |    |      |
|  | A2201Q2   | L    |    | 295 €      | 295 € | ES-1     | 1    | 1     | 2  | 0.09 |
|  |  |      |    |            |       |          |      |       |    |      |

COM/COL - Minimum Q.ty 6 pc. for each material. For weft or patterned fabrics see specific pages

|  |                        |
|--|------------------------|
|  | Mtl. 1.00 h. 1.40 Each |
|--|------------------------|

### Cushion finishes

#### Upholstery

|           |  |
|-----------|--|
| <b>TC</b> | FABRIC Flame, FABRIC Ouche, FABRIC Plain |
|-----------|--|

#### Optionals:

|             |                | Value  | Options/notes |
|-------------|----------------|--------|---------------|
| <b>ES-1</b> | Fireproof foam | + 16 € | ES-1          |

#### Bolle Cushion S

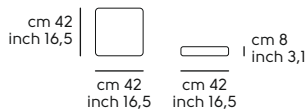

#### Bolle Cushion M

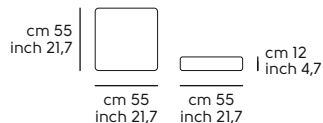



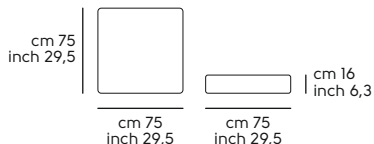









#### Bolle Cushion L



# Calla design Fabrizio Batoni

## Calla S, DS - Shell in polypropylene

Frame in: metal or wood

| Model  | Code      | Base type | Frame | Shell | Optional   | Q.ty   | boxes  | Kg         | M <sup>3</sup> |
|--|-----------|-----------|-------|-------|--|--------|--------|------------|----------------|
| PP1  |           |           |       |       |  |        |        |            |                |
| <b>Chair CALLA S M_M PP</b><br>          | S1920SP_M | _M        | M1    | 164 € | FM-M2<br>FM-M3<br>FM-M4<br>FM-O1<br>FM-O2<br>PD-F0 | 2<br>4 | 1<br>1 | 12<br>23.0 | 0.30<br>0.45   |
| <b>Chair CALLA S M_T PP</b><br>          | S1920SP_T | _T        | M1    | 187 € | FM-M2<br>FM-O1<br>FM-O2                            | 2<br>4 | 1<br>1 | 12<br>23.0 | 0.30<br>0.45   |
| <b>Chair CALLA S M_Q PP</b><br>        | S1920SP_Q | _Q        | M1    | 202 € | FM-M2<br>FM-O1<br>FM-O2<br>PD-F0                   | 2      | 1      | 12         | 0.30           |
| <b>Chair CALLA S M_X PP</b><br>      | S1920SP_X | _X        | M1    | 184 € | FM-M2<br>FM-M3<br>FM-M4<br>FM-O1<br>FM-O2<br>PD-F0 | 2      | 1      | 12         | 0.30           |
| <b>Chair CALLA S L_C PP</b><br>   | S1925WP_C | _C        | LF1   | 249 € | PD-F0  | 2      | 1      | 12         | 0.35           |
| <b>Chair CALLA S L_N PP</b><br>      | S1925WP_N | _N        | LII   | 344 € | FL-I2<br>PD-F0                                     | 2      | 1      | 12         | 0.35           |
| <b>Office Chair CALLA DS PP</b><br>  | S1920DP   | DS        | M1    | 337 € | FM-M2<br>FM-M3                                     | 1      | 2      | 9.5        | 0.27           |

**Note:**

Linking device available for T base. See Accessories section

**Frame finishes**

**Metal**

|           |   |
|-----------|---|
| <b>MI</b> | WHITE <b>BB</b> , BROWN <b>E6</b> , SAND <b>EC</b> , WHITE PEARL <b>EF</b> , GRAPHITE <b>EG</b> , BLACK <b>EN</b> |
|-----------|---|

**Wood**

|            |  |
|------------|--|
| <b>LFI</b> | Ash wood stained BLACK <b>F04</b> , Ash wood stained WHITE <b>F05</b> , Ash wood stained CHERRY RED <b>F09</b> , Ash wood stained FLAMED WALNUT <b>F24</b> , Ash wood stained DARK BROWN <b>F26</b> , Ash wood stained NATURAL <b>F40</b> , Ash wood stained NATURAL OAK <b>F52</b> , Ash wood stained WHITENED <b>F60</b> , Ash wood stained DESERT <b>F61</b> , Ash wood stained LIGHT GREY <b>F62</b> , Ash wood stained DARK GREY <b>F63</b>       |
| <b>LII</b> | Veneered wood painted BLACK <b>I04</b> , Veneered wood painted WHITE <b>I05</b> , Veneered wood painted CHERRY RED <b>I09</b> , Veneered wood painted DARK BROWN <b>I26</b> , Veneered wood painted NATURAL <b>I40</b> , Veneered wood painted NATURAL OAK <b>I52</b> , Veneered wood painted WHITENED <b>I60</b> , Veneered wood painted DESERT <b>I61</b> , Veneered wood painted LIGHT GREY <b>I62</b> , Veneered wood painted DARK GREY <b>I63</b> |

**Shell finishes**

**Polypropylene**

|            |  |
|------------|--|
| <b>PPI</b> | WHITE <b>PB4</b> , GRAFITE GREY <b>PGD</b> , SKY GREY <b>PGU</b> , BROWN <b>PM2</b> , BLACK <b>PN4</b> , OCHER YELLOW <b>PO2</b> , RED <b>PRR</b> , RED BULGARO <b>PRS</b> , SAND <b>PS2</b> , TERRACOTTA <b>PT2</b> , DARK GREEN <b>PVL</b> |
|------------|--|





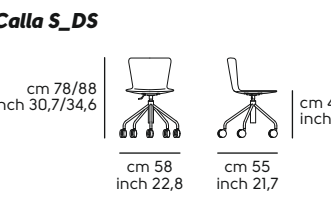
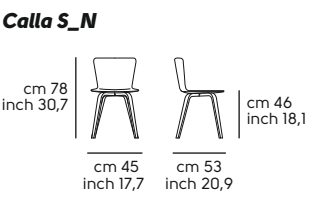
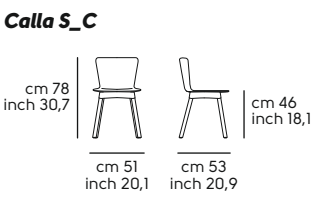
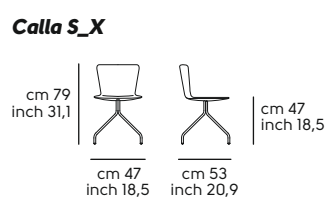
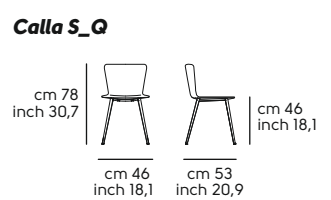
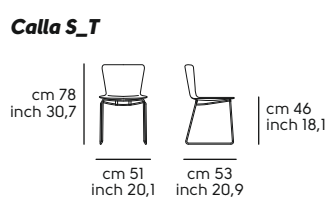
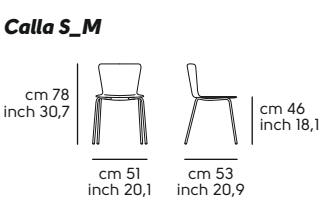



**Optionals:**

|              |                          | Value   | Options/notes  |
|--------------|--------------------------|---------|--|
| <b>FM-M2</b> | Indoor matt metal M2     | + 48 €  | ASH GREY <b>ES</b> , BLUE SAPPHIRE <b>EE</b> , BLUE TURQUOISE <b>EH</b> , BRONZE <b>E2</b> , BULGARO RED <b>FP</b> , CHERRY RED <b>EQ</b> , DARK GREEN <b>EL</b> , FACEPOWDER PINK <b>E8</b> , FANGO <b>E3</b> , GOLDEN YELLOW <b>EO</b> , LIGHT BLUE <b>EO</b> , LIGHT GREY <b>ET</b> , OCEAN BLUE <b>E1</b> , OCHER YELLOW <b>E7</b> , PAPAYA ORANGE <b>EA</b> , PASTEL YELLOW <b>E4</b> , PINE GREEN <b>EJ</b> , RED <b>ER</b> , SAGE GREEN <b>E9</b>   |
| <b>FM-M3</b> | Indoor glossy metal M3   | + 26 €  | CHROME <b>CC</b>   |
| <b>FM-M4</b> | Indoor glossy Metal M4   | + 123 € | BLACK NICKEL <b>DZ</b> , CHAMPAGNE GOLD <b>DG</b> , GOLDEN BRONZE <b>DB</b> , MATT BLACK NICKEL <b>DY</b> , MATT GOLDEN BRONZE <b>DC</b> , PINK GOLD <b>DR</b>   |
| <b>FM-O1</b> | Outdoor metal O1         | + 42 €  | Outdoor BLACK <b>EN</b> , Outdoor BROWN <b>E6</b> , Outdoor GRAFITE <b>EG</b> , Outdoor SAND <b>EC</b> , Outdoor WHITE PEARL <b>EF</b> , Outdoor WHITE <b>BB</b>   |
| <b>FM-O2</b> | Outdoor metal O2         | + 96 €  | Outdoor ASH GREY <b>ES</b> , Outdoor BLUE SAPPHIRE <b>EE</b> , Outdoor BLUE TURQUOISE <b>EH</b> , Outdoor BRONZE <b>E2</b> , Outdoor CHERRY RED <b>EQ</b> , Outdoor DARK GREEN <b>EL</b> , Outdoor FACEPOWDER PINK <b>E8</b> , Outdoor FANGO <b>E3</b> , Outdoor GOLD YELLOW <b>EO</b> , Outdoor LIGHT BLUE <b>EO</b> , Outdoor LIGHT GREY <b>ET</b> , Outdoor OCEAN BLUE <b>E1</b> , Outdoor OCHER YELLOW <b>E7</b> , Outdoor PAPAYA ORANGE <b>EA</b> , Outdoor PASTEL YELLOW <b>E4</b> , Outdoor PINE GREEN <b>EJ</b> , Outdoor RED BULGARO <b>FP</b> , Outdoor RED <b>ER</b> , Outdoor SAGE GREEN <b>E9</b> |
| <b>FL-I2</b> | Veneered wood finish LI2 | + 6 €   | Veneered wood FLAMED WALNUT <b>I24</b> , Veneered wood NATURAL OAK <b>I22</b>  |
| <b>PD-F0</b> | Felt pad feet            | + 6 €   | PD-F0  |



**Calla S, DS - Shell in polypropylene, seat in fabric or leather**

Frame in: metal or wood

| Model  | Code      | Base type | Frame | Shell PPI / Seat |       |       |       |       |       |       |       |       | Optional                                 | Q.ty   | boxes  | Kg         | M³           |
|--|-----------|-----------|-------|------------------|-------|-------|-------|-------|-------|-------|-------|-------|--|--------|--------|------------|--------------|
|  |           |           |       | TA               | TB    | TC    | TD    | TE    | SF    | SV    | COM   | COL   |  |        |        |            |              |
| <b>Chair CALLA S M_M PP_TS</b><br>            | S1920SS_M | _M        | MI    | 220 €            | 233 € | 246 € | 284 € | 393 € | 260 € | 269 € | 225 € | 246 € | FM-M2<br>FM-M3<br>FM-M4<br>ES-1<br>PD-F0 | 2<br>4 | 1<br>1 | 12<br>23.0 | 0.30<br>0.45 |
| <b>Stackable Chair CALLA S M_M PP_TS</b><br>  | S1929SS_M | _M        | MI    | 237 €            | 251 € | 263 € | 302 € | 411 € | 278 € | 287 € | 241 € | 263 € | FM-M2<br>FM-M3<br>FM-M4<br>ES-1<br>PD-F0 | 2<br>4 | 1<br>1 | 12<br>23.0 | 0.30<br>0.45 |
| <b>Chair CALLA S M_T PP_TS</b><br>            | S1920SS_T | _T        | MI    | 245 €            | 258 € | 271 € | 309 € | 418 € | 285 € | 294 € | 250 € | 271 € | FM-M2<br>ES-1                            | 2<br>4 | 1<br>1 | 12<br>23.0 | 0.30<br>0.45 |
| <b>Stackable Chair CALLA S M_T PP_TS</b><br> | S1929SS_T | _T        | MI    | 262 €            | 276 € | 288 € | 327 € | 436 € | 303 € | 312 € | 266 € | 288 € | FM-M2<br>ES-1                            | 2<br>4 | 1<br>1 | 12<br>23.0 | 0.30<br>0.45 |
| <b>Chair CALLA S M_Q PP_TS</b><br>          | S1920SS_Q | _Q        | MI    | 258 €            | 271 € | 284 € | 322 € | 431 € | 298 € | 307 € | 263 € | 284 € | FM-M2<br>ES-1<br>PD-F0                   | 2      | 1      | 12         | 0.30         |
| <b>Chair CALLA S M_X PP_TS</b><br>          | S1920SS_X | _X        | MI    | 245 €            | 258 € | 271 € | 309 € | 418 € | 285 € | 294 € | 250 € | 271 € | FM-M2<br>FM-M3<br>FM-M4<br>ES-1<br>PD-F0 | 2      | 1      | 12         | 0.30         |
| <b>Chair CALLA S L_C PP_TS</b><br>          | S1925WS_C | _C        | LF1   | 303 €            | 318 € | 331 € | 369 € | 478 € | 345 € | 354 € | 309 € | 331 € | ES-1<br>PD-F0                            | 2      | 1      | 12         | 0.35         |
| <b>Chair CALLA S L_N PP_TS</b><br>          | S1925WS_N | _N        | LII   | 391 €            | 406 € | 419 € | 457 € | 566 € | 433 € | 442 € | 397 € | 419 € | FL-I2<br>ES-1<br>PD-F0                   | 2      | 1      | 12         | 0.35         |
| <b>Office Chair CALLA DS PP_TS</b><br>      | S1920DS   | DS        | MI    | 394 €            | 409 € | 422 € | 462 € | 571 € | 436 € | 444 € | 401 € | 422 € | FM-M2<br>FM-M3<br>ES-1                   | 1      | 2      | 9.5        | 0.27         |

**Note:**

Linking device available for T base. See Accessories section

**Frame finishes**

|              |   |
|--------------|---|
| <b>Metal</b> |   |
| <b>MI</b>    | WHITE <b>BB</b> , BROWN <b>E6</b> , SAND <b>EC</b> , WHITE PEARL <b>EF</b> , GRAPHITE <b>EG</b> , BLACK <b>EN</b> |

|             |  |
|-------------|--|
| <b>Wood</b> |  |
| <b>LFI</b>  | Ash wood stained BLACK <b>F04</b> , Ash wood stained WHITE <b>F05</b> , Ash wood stained CHERRY RED <b>F09</b> , Ash wood stained FLAMED WALNUT <b>F24</b> , Ash wood stained DARK BROWN <b>F26</b> , Ash wood stained NATURAL <b>F40</b> , Ash wood stained NATURAL OAK <b>F52</b> , Ash wood stained WHITENED <b>F60</b> , Ash wood stained DESERT <b>F61</b> , Ash wood stained LIGHT GREY <b>F62</b> , Ash wood stained DARK GREY <b>F63</b>       |
| <b>LII</b>  | Veneered wood painted BLACK <b>I04</b> , Veneered wood painted WHITE <b>I05</b> , Veneered wood painted CHERRY RED <b>I09</b> , Veneered wood painted DARK BROWN <b>I26</b> , Veneered wood painted NATURAL <b>I40</b> , Veneered wood painted NATURAL OAK <b>I52</b> , Veneered wood painted WHITENED <b>I60</b> , Veneered wood painted DESERT <b>I61</b> , Veneered wood painted LIGHT GREY <b>I62</b> , Veneered wood painted DARK GREY <b>I63</b> |



**Shell finishes**

|                      |  |
|----------------------|--|
| <b>Polypropylene</b> |  |
| <b>PP1</b>           | WHITE <b>PB4</b> , GRAFITE GREY <b>PGD</b> , SKY GREY <b>PGU</b> , BROWN <b>PM2</b> , BLACK <b>PN4</b> , OCHER YELLOW <b>PO2</b> , RED <b>PRR</b> , RED BULGARO <b>PRS</b> , SAND <b>PS2</b> , TERRACOTTA <b>PT2</b> , DARK GREEN <b>PVL</b> |

**Seat finishes**

|                   |   |
|-------------------|---|
| <b>Upholstery</b> |   |
| <b>TA</b>         | FAUX LEATHER <b>Secret</b> , FABRIC <b>Mirage</b> , FABRIC <b>Cotton Club</b> , FABRIC <b>Renewed Loop</b>  |
| <b>TB</b>         | FAUX LEATHER <b>Vintage</b> , FABRIC <b>Fenix Wool</b> , FABRIC <b>Visual</b> , FABRIC <b>Manhattan</b> , FABRIC <b>Novabuk</b> , FABRIC <b>Network</b> , FABRIC <b>Gyre</b>  |
| <b>TC</b>         | VELVET SUPERB, FABRIC <b>Second</b> , FABRIC <b>Main Line Flax</b> , FABRIC <b>Oceanic</b> , FABRIC <b>Jumper</b> , FABRIC <b>Flame</b> , FABRIC <b>Ouche</b> , FABRIC <b>Plain</b> , FABRIC <b>Gemma</b> , FABRIC <b>Callagirone 114</b> |
| <b>TD</b>         | FABRIC <b>Yoredale</b> , FABRIC <b>Remix 3</b>  |
| <b>TE</b>         | FABRIC <b>Uniform Melange</b>   |
| <b>SF</b>         | LEATHER <b>Fiore</b>  |
| <b>SV</b>         | LEATHER <b>Vintage</b>  |

**COM/COL - Minimum Q.ty 6 pc. for each material. For weft or patterned fabrics see specific pages**

|   |                        |  |               |
|---|------------------------|--|---------------|
|  <b>COM</b> | Mtl. 0.60 h. 1.40 Each |  <b>COL</b> | Mq. 0.70 Each |
|---|------------------------|--|---------------|

**Optionals:**

|              | Value   | Options/notes  |
|--------------|---------|--|
| <b>FM-M2</b> | + 48 €  | ASH GREY <b>ES</b> , BLUE SAPPHIRE <b>EE</b> , BLUE TURQUOISE <b>EH</b> , BRONZE <b>E2</b> , BULGARO RED <b>FP</b> , CHERRY RED <b>EQ</b> , DARK GREEN <b>EL</b> , FACEPOWDER PINK <b>E8</b> , FANGO <b>E3</b> , GOLDEN YELLOW <b>EO</b> , LIGHT BLUE <b>EO</b> , LIGHT GREY <b>ET</b> , OCEAN BLUE <b>E1</b> , OCHER YELLOW <b>E7</b> , PAPAYA ORANGE <b>EA</b> , PASTEL YELLOW <b>E4</b> , PINE GREEN <b>EJ</b> , RED <b>ER</b> , SAGE GREEN <b>E9</b> |
| <b>FM-M3</b> | + 21 €  | CHROME <b>CC</b>   |
| <b>FM-M4</b> | + 123 € | BLACK NICKEL <b>DZ</b> , CHAMPAGNE GOLD <b>DG</b> , GOLDEN BRONZE <b>DB</b> , MATT BLACK NICKEL <b>DY</b> , MATT GOLDEN BRONZE <b>DC</b> , PINK GOLD <b>DR</b>   |
| <b>FL-I2</b> | + 6 €   | Veneered wood FLAMED WALNUT <b>I24</b> , Veneered wood NATURAL OAK <b>I22</b>  |
| <b>ES-1</b>  | + 5 €   | ES-1   |
| <b>PD-F0</b> | + 6 €   | PD-F0  |

**Calla S\_M**

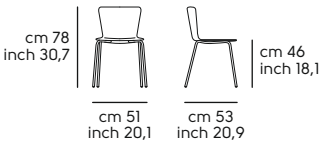

**Calla S\_T**

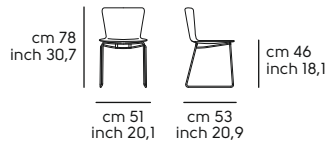

**Calla S\_Q**

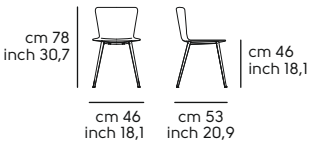

**Calla S\_X**

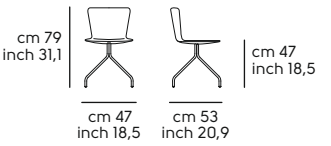

**Calla S\_C**

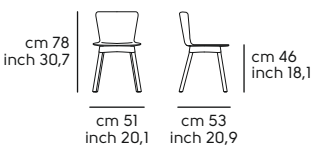

**Calla S\_N**

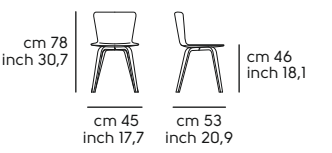



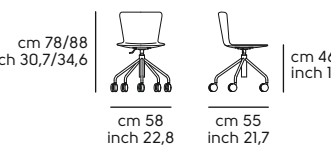





**Calla S\_DS**



**Calla S, DS - Shell in fabric or leather**

Frame in: metal or wood

| Model   | Code      | Base type | Frame | Upholstered shell |       |       |       |       |       |       |       |       | Optional                                 | Q.ty   | boxes  | Kg         | M <sup>2</sup> |
|---|-----------|-----------|-------|-------------------|-------|-------|-------|-------|-------|-------|-------|-------|--|--------|--------|------------|----------------|
|   |           |           |       | TA                | TB    | TC    | TD    | TE    | SF    | SV    | COM   | COL   |  |        |        |            |                |
| <b>Chair CALLA S M_M TS</b><br>            | S1920ST_M | _M        | M1    | 255 €             | 281 € | 324 € | 352 € | 508 € | 368 € | 434 € | 260 € | 324 € | FM-M2<br>FM-M3<br>FM-M4<br>ES-1<br>PD-FO | 2<br>4 | 1<br>1 | 13<br>25.0 | 0.30<br>0.45   |
| <b>Stackable Chair CALLA S M_M TS</b><br>  | S1929ST_M | _M        | M1    | 272 €             | 300 € | 342 € | 369 € | 525 € | 386 € | 452 € | 278 € | 342 € | FM-M2<br>FM-M3<br>FM-M4<br>ES-1<br>PD-FO | 2<br>4 | 1<br>1 | 13<br>25.0 | 0.30<br>0.45   |
| <b>Chair CALLA S M_T TS</b><br>            | S1920ST_T | _T        | M1    | 279 €             | 305 € | 348 € | 376 € | 532 € | 392 € | 458 € | 284 € | 348 € | FM-M2<br>ES-1                            | 2<br>4 | 1<br>1 | 13<br>25.0 | 0.30<br>0.45   |
| <b>Stackable Chair CALLA S M_T TS</b><br> | S1929ST_T | _T        | M1    | 296 €             | 324 € | 366 € | 393 € | 549 € | 410 € | 476 € | 302 € | 366 € | FM-M2<br>ES-1                            | 2<br>4 | 1<br>1 | 13<br>25.0 | 0.30<br>0.45   |
| <b>Chair CALLA S M_Q TS</b><br>          | S1920ST_Q | _Q        | M1    | 293 €             | 319 € | 362 € | 390 € | 546 € | 406 € | 472 € | 298 € | 362 € | FM-M2<br>ES-1<br>PD-FO                   | 2      | 1      | 13         | 0.30           |
| <b>Chair CALLA S M_X TS</b><br>          | S1920ST_X | _X        | M1    | 275 €             | 301 € | 344 € | 372 € | 528 € | 388 € | 454 € | 280 € | 344 € | FM-M2<br>FM-M3<br>FM-M4<br>ES-1<br>PD-FO | 2      | 1      | 13         | 0.30           |
| <b>Chair CALLA S L_C TS</b><br>          | S1925WT_C | _C        | LF1   | 340 €             | 368 € | 410 € | 438 € | 593 € | 456 € | 518 € | 340 € | 410 € | ES-1<br>PD-FO                            | 2      | 1      | 13         | 0.35           |
| <b>Chair CALLA S L_N TS</b><br>          | S1925WT_N | _N        | L11   | 427 €             | 455 € | 497 € | 525 € | 680 € | 543 € | 605 € | 427 € | 497 € | FL-I2<br>ES-1<br>PD-FO                   | 2      | 1      | 13         | 0.35           |
| <b>Office Chair CALLA DS TS</b><br>      | S1920DT   | DS        | M1    | 427 €             | 458 € | 498 € | 528 € | 681 € | 545 € | 609 € | 436 € | 498 € | FM-M2<br>FM-M3<br>ES-1                   | 1      | 2      | 9.5        | 0.27           |

**Note:**

TS Front and Back covering available in two-tone or bi-material. Reference price in the upper category. Linking device available for T base. See Accessories section. Class IIM certification available with Secret Faux leather fabric

**Frame finishes**

**Metal**

|           |   |
|-----------|---|
| <b>MI</b> | WHITE <b>BB</b> , BROWN <b>E6</b> , SAND <b>EC</b> , WHITE PEARL <b>EF</b> , GRAPHITE <b>EG</b> , BLACK <b>EN</b> |
|-----------|---|

**Wood**



|            |  |
|------------|--|
| <b>LFI</b> | Ash wood stained BLACK <b>F04</b> , Ash wood stained WHITE <b>F05</b> , Ash wood stained CHERRY RED <b>F09</b> , Ash wood stained FLAMED WALNUT <b>F24</b> , Ash wood stained DARK BROWN <b>F26</b> , Ash wood stained NATURAL <b>F40</b> , Ash wood stained NATURAL OAK <b>F52</b> , Ash wood stained WHITENED <b>F60</b> , Ash wood stained DESERT <b>F61</b> , Ash wood stained LIGHT GREY <b>F62</b> , Ash wood stained DARK GREY <b>F63</b>       |
| <b>LII</b> | Veneered wood painted BLACK <b>I04</b> , Veneered wood painted WHITE <b>I05</b> , Veneered wood painted CHERRY RED <b>I09</b> , Veneered wood painted DARK BROWN <b>I26</b> , Veneered wood painted NATURAL <b>I40</b> , Veneered wood painted NATURAL OAK <b>I52</b> , Veneered wood painted WHITENED <b>I60</b> , Veneered wood painted DESERT <b>I61</b> , Veneered wood painted LIGHT GREY <b>I62</b> , Veneered wood painted DARK GREY <b>I63</b> |

**Shell finishes**

**Upholstery**

|           |   |           |  |
|-----------|---|-----------|--|
| <b>TA</b> | FAUX LEATHER <b>Secret</b> , FABRIC <b>Mirage</b> , FABRIC <b>Cotton Club</b> , FABRIC <b>Renewed Loop</b>  | <b>TB</b> | FAUX LEATHER <b>Vintage</b> , FABRIC <b>Fenix Wool</b> , FABRIC <b>Visual</b> , FABRIC <b>Manhattan</b> , FABRIC <b>Novabuk</b> , FABRIC <b>Network</b> , FABRIC <b>Gyre</b> |
| <b>TC</b> | VELVET SUPERB, FABRIC <b>Second</b> , FABRIC <b>Main Line Flax</b> , FABRIC <b>Oceanic</b> , FABRIC <b>Jumper</b> , FABRIC <b>Flame</b> , FABRIC <b>Ouche</b> , FABRIC <b>Plain</b> , FABRIC <b>Gemma</b> , FABRIC <b>Callagirone 114</b> | <b>TD</b> | FABRIC <b>Yoredale</b> , FABRIC <b>Remix 3</b>   |
| <b>TE</b> | FABRIC <b>Uniform Melange</b>   | <b>SF</b> | LEATHER <b>Fiore</b>   |
| <b>SV</b> | LEATHER <b>Vintage</b>  |           |  |

**COM/COL - Minimum Q.ty 6 pc. for each material. For weft or patterned fabrics see specific pages**

|  |                        |   |               |
|--|------------------------|---|---------------|
|  <b>COM</b> | Mtl. 0.92 h. 1.40 Each |  <b>COL</b> | Mq. 1.90 Each |
|--|------------------------|---|---------------|

**Optionals:**

|              | Value   | Options/notes  |
|--------------|---------|--|
| <b>FM-M2</b> | + 48 €  | ASH GREY <b>ES</b> , BLUE SAPPHIRE <b>EE</b> , BLUE TURQUOISE <b>EH</b> , BRONZE <b>E2</b> , BULGARO RED <b>FP</b> , CHERRY RED <b>EQ</b> , DARK GREEN <b>EL</b> , FACEPOWDER PINK <b>E8</b> , FANGO <b>E3</b> , GOLDEN YELLOW <b>EO</b> , LIGHT BLUE <b>EO</b> , LIGHT GREY <b>ET</b> , OCEAN BLUE <b>E1</b> , OCHER YELLOW <b>E7</b> , PAPAYA ORANGE <b>EA</b> , PASTEL YELLOW <b>E4</b> , PINE GREEN <b>EJ</b> , RED <b>ER</b> , SAGE GREEN <b>E9</b> |
| <b>FM-M3</b> | + 21 €  | CHROME <b>CC</b>   |
| <b>FM-M4</b> | + 123 € | BLACK NICKEL <b>DZ</b> , CHAMPAGNE GOLD <b>DG</b> , GOLDEN BRONZE <b>DB</b> , MATT BLACK NICKEL <b>DY</b> , MATT GOLDEN BRONZE <b>DC</b> , PINK GOLD <b>DR</b>   |
| <b>FL-I2</b> | + 6 €   | Veneered wood FLAMED WALNUT <b>I24</b> , Veneered wood NATURAL OAK <b>I22</b>  |
| <b>ES-1</b>  | + 6 €   | ES-1   |
| <b>PD-F0</b> | + 6 €   | PD-F0  |

**Calla S\_M**

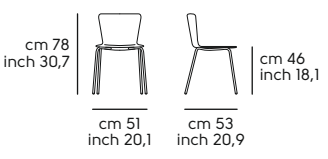

**Calla S\_T**

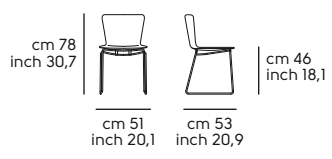

**Calla S\_G**

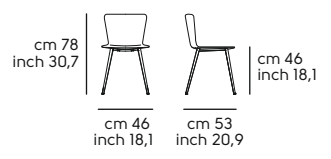

**Calla S\_X**

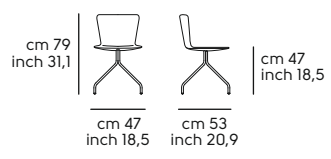

**Calla S\_C**



**Calla S\_N**

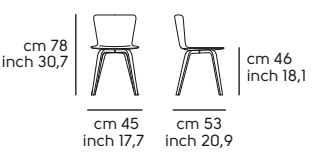



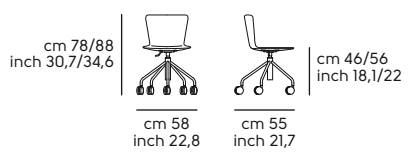



**Calla S\_DS**



**Calla P, DP - Shell in polypropylene**

Frame in: metal or wood

| Model   | Code      | Base type | Frame | Shell | Optional   | Q.ty | boxes | Kg | M <sup>3</sup> |
|---|-----------|-----------|-------|-------|--|------|-------|----|----------------|
| PP1   |           |           |       |       |  |      |       |    |                |
| <b>Armchair CALLA P M_M PP</b><br>   | S1921PP_M | _M        | M1    | 189 € | FM-M2<br>FM-M3<br>FM-M4<br>FM-O1<br>FM-O2<br>PD-F0 | 1    | 1     | 7  | 0.26           |
| <b>Armchair CALLA P M_T PP</b><br>   | S1921PP_T | _T        | M1    | 213 € | FM-M2<br>FM-O1<br>FM-O2                            | 1    | 1     | 7  | 0.26           |
| <b>Armchair CALLA P M_Q PP</b><br>   | S1921PP_Q | _Q        | M1    | 227 € | FM-M2<br>FM-O1<br>FM-O2<br>PD-F0                   | 1    | 1     | 7  | 0.26           |
| <b>Armchair CALLA P M_X PP</b><br>  | S1921PP_X | _X        | M1    | 210 € | FM-M2<br>FM-M3<br>FM-M4<br>FM-O1<br>FM-O2<br>PD-F0 | 1    | 1     | 7  | 0.26           |
| <b>Armchair CALLA P L_C PP</b><br> | S1926WP_C | _C        | LF1   | 275 € | PD-F0  | 1    | 1     | 7  | 0.26           |
| <b>Armchair CALLA P L_N PP</b><br> | S1926WP_N | _N        | L11   | 362 € | FL-I2<br>PD-F0                                     | 1    | 1     | 7  | 0.26           |
| <b>Office Arm. CALLA DP PP</b><br> | S1921DP   | DP        | M1    | 369 € | FM-M2<br>FM-M3                                     | 1    | 2     | 10 | 0.29           |

**Note:**

Linking device available for T base. See Accessories section. Available in the DISASSEMBLED version with 4 euro price reduction. Min. 20 pcs.

**Frame finishes**

**Metal**

|           |   |
|-----------|---|
| <b>MI</b> | WHITE <b>BB</b> , BROWN <b>E6</b> , SAND <b>EC</b> , WHITE PEARL <b>EF</b> , GRAPHITE <b>EG</b> , BLACK <b>EN</b> |
|-----------|---|

**Wood**

|            |  |
|------------|--|
| <b>LFI</b> | Ash wood stained BLACK <b>F04</b> , Ash wood stained WHITE <b>F05</b> , Ash wood stained CHERRY RED <b>F09</b> , Ash wood stained FLAMED WALNUT <b>F24</b> , Ash wood stained DARK BROWN <b>F26</b> , Ash wood stained NATURAL <b>F40</b> , Ash wood stained NATURAL OAK <b>F52</b> , Ash wood stained WHITENED <b>F60</b> , Ash wood stained DESERT <b>F61</b> , Ash wood stained LIGHT GREY <b>F62</b> , Ash wood stained DARK GREY <b>F63</b>       |
| <b>LII</b> | Veneered wood painted BLACK <b>I04</b> , Veneered wood painted WHITE <b>I05</b> , Veneered wood painted CHERRY RED <b>I09</b> , Veneered wood painted DARK BROWN <b>I26</b> , Veneered wood painted NATURAL <b>I40</b> , Veneered wood painted NATURAL OAK <b>I52</b> , Veneered wood painted WHITENED <b>I60</b> , Veneered wood painted DESERT <b>I61</b> , Veneered wood painted LIGHT GREY <b>I62</b> , Veneered wood painted DARK GREY <b>I63</b> |

**Shell finishes**

**Polypropylene**

|            |  |
|------------|--|
| <b>PPI</b> | WHITE <b>PB4</b> , GRAFITE GREY <b>PGD</b> , SKY GREY <b>PGU</b> , BROWN <b>PM2</b> , BLACK <b>PN4</b> , OCHER YELLOW <b>PO2</b> , RED <b>PRR</b> , RED BULGARO <b>PRS</b> , SAND <b>PS2</b> , TERRACOTTA <b>PT2</b> , DARK GREEN <b>PVL</b> |
|------------|--|

**Optionals:**

|              |                          | Value   | Options/notes  |
|--------------|--------------------------|---------|--|
| <b>FM-M2</b> | Indoor matt metal M2     | + 48 €  | ASH GREY <b>ES</b> , BLUE SAPPHIRE <b>EE</b> , BLUE TURQUOISE <b>EH</b> , BRONZE <b>E2</b> , BULGARO RED <b>FP</b> , CHERRY RED <b>EQ</b> , DARK GREEN <b>EL</b> , FACEPOWDER PINK <b>E8</b> , FANGO <b>E3</b> , GOLDEN YELLOW <b>EO</b> , LIGHT BLUE <b>EO</b> , LIGHT GREY <b>ET</b> , OCEAN BLUE <b>E1</b> , OCHER YELLOW <b>E7</b> , PAPAYA ORANGE <b>EA</b> , PASTEL YELLOW <b>E4</b> , PINE GREEN <b>EJ</b> , RED <b>ER</b> , SAGE GREEN <b>E9</b>   |
| <b>FM-M3</b> | Indoor glossy metal M3   | + 21 €  | CHROME <b>CC</b>   |
| <b>FM-M4</b> | Indoor glossy Metal M4   | + 123 € | BLACK NICKEL <b>DZ</b> , CHAMPAGNE GOLD <b>DG</b> , GOLDEN BRONZE <b>DB</b> , MATT BLACK NICKEL <b>DY</b> , MATT GOLDEN BRONZE <b>DC</b> , PINK GOLD <b>DR</b>   |
| <b>FM-O1</b> | Outdoor metal O1         | + 42 €  | Outdoor BLACK <b>EN</b> , Outdoor BROWN <b>E6</b> , Outdoor GRAFITE <b>EG</b> , Outdoor SAND <b>EC</b> , Outdoor WHITE PEARL <b>EF</b> , Outdoor WHITE <b>BB</b>   |
| <b>FM-O2</b> | Outdoor metal O2         | + 96 €  | Outdoor ASH GREY <b>ES</b> , Outdoor BLUE SAPPHIRE <b>EE</b> , Outdoor BLUE TURQUOISE <b>EH</b> , Outdoor BRONZE <b>E2</b> , Outdoor CHERRY RED <b>EQ</b> , Outdoor DARK GREEN <b>EL</b> , Outdoor FACEPOWDER PINK <b>E8</b> , Outdoor FANGO <b>E3</b> , Outdoor GOLD YELLOW <b>EO</b> , Outdoor LIGHT BLUE <b>EO</b> , Outdoor LIGHT GREY <b>ET</b> , Outdoor OCEAN BLUE <b>E1</b> , Outdoor OCHER YELLOW <b>E7</b> , Outdoor PAPAYA ORANGE <b>EA</b> , Outdoor PASTEL YELLOW <b>E4</b> , Outdoor PINE GREEN <b>EJ</b> , Outdoor RED BULGARO <b>FP</b> , Outdoor RED <b>ER</b> , Outdoor SAGE GREEN <b>E9</b> |
| <b>FL-I2</b> | Veneered wood finish LI2 | + 6 €   | Veneered wood FLAMED WALNUT <b>I24</b> , Veneered wood NATURAL OAK <b>I22</b>  |
| <b>PD-F0</b> | Felt pad feet            | + 6 €   | PD-F0  |

**Calla P\_M**

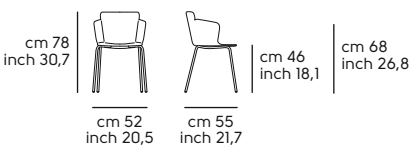

**Calla P\_T**

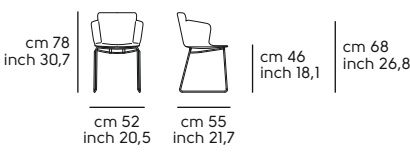

**Calla P\_Q**

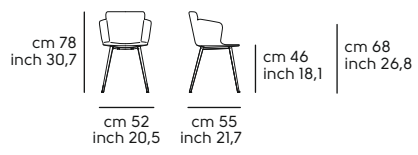

**Calla P\_X**

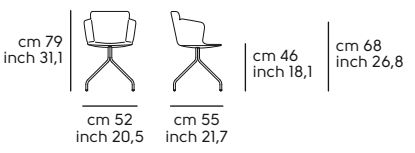

**Calla P\_C**

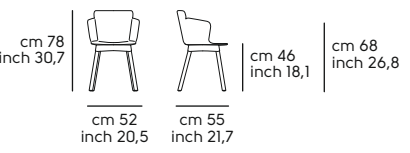

**Calla P\_N**

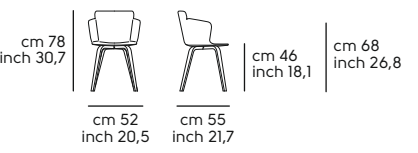



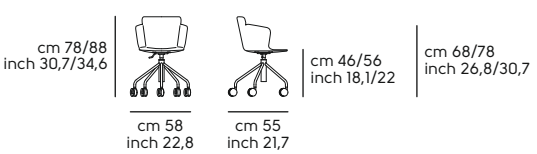



**Calla P\_DP**



**Calla P, DP - Shell in polypropylene, seat in fabric or leather**

Frame in: metal or wood

| Model  | Code      | Base type | Frame | Shell PPI / Seat |       |       |       |       |       |       |       |       | Optional                                 | Q.ty | boxes | Kg | M³   |
|--|-----------|-----------|-------|------------------|-------|-------|-------|-------|-------|-------|-------|-------|--|------|-------|----|------|
|  |           |           |       | TA               | TB    | TC    | TD    | TE    | SF    | SV    | COM   | COL   |  |      |       |    |      |
| <b>Armchair CALLA P M_M PP_TS</b><br>   | S1921PS_M | _M        | M1    | 246 €            | 258 € | 272 € | 311 € | 417 € | 286 € | 329 € | 252 € | 272 € | FM-M2<br>FM-M3<br>FM-M4<br>ES-1<br>PD-F0 | 1    | 1     | 7  | 0.26 |
| <b>Armchair CALLA P M_T PP_TS</b><br>   | S1921PS_T | _T        | M1    | 269 €            | 281 € | 295 € | 334 € | 440 € | 309 € | 352 € | 275 € | 295 € | FM-M2<br>ES-1                            | 1    | 1     | 7  | 0.26 |
| <b>Armchair CALLA P M_Q PP_TS</b><br>   | S1921PS_Q | _Q        | M1    | 283 €            | 295 € | 309 € | 348 € | 454 € | 323 € | 366 € | 289 € | 309 € | FM-M2<br>ES-1<br>PD-F0                   | 1    | 1     | 7  | 0.26 |
| <b>Armchair CALLA P M_X PP_TS</b><br>  | S1921PS_X | _X        | M1    | 266 €            | 278 € | 292 € | 331 € | 437 € | 306 € | 349 € | 272 € | 292 € | FM-M2<br>FM-M3<br>FM-M4<br>ES-1<br>PD-F0 | 1    | 1     | 7  | 0.26 |
| <b>Armchair CALLA P L_C PP_TS</b><br> | S1926WS_C | _C        | LFI   | 331 €            | 346 € | 360 € | 397 € | 502 € | 372 € | 415 € | 337 € | 360 € | ES-1<br>PD-F0                            | 1    | 1     | 7  | 0.26 |
| <b>Armchair CALLA P L_N PP_TS</b><br> | S1926WS_N | _N        | LII   | 421 €            | 436 € | 450 € | 487 € | 592 € | 462 € | 505 € | 427 € | 450 € | FL-I2<br>ES-1<br>PD-F0                   | 1    | 1     | 7  | 0.26 |
| <b>Office Arm. CALLA DP PP_TS</b><br> | S1921DS   | DP        | M1    | 426 €            | 441 € | 456 € | 494 € | 600 € | 469 € | 512 € | 435 € | 456 € | FM-M2<br>FM-M3<br>ES-1                   | 1    | 2     | 10 | 0.29 |

**Note:**

Linking device available for T base. See Accessories section. Available in the DISASSEMBLED version with 4 euro price reduction. Min. 20 pcs.

**Frame finishes**

**Metal**

|           |   |
|-----------|---|
| <b>MI</b> | WHITE <b>BB</b> , BROWN <b>E6</b> , SAND <b>EC</b> , WHITE PEARL <b>EF</b> , GRAPHITE <b>EG</b> , BLACK <b>EN</b> |
|-----------|---|

**Wood**

|            |  |
|------------|--|
| <b>LFI</b> | Ash wood stained BLACK <b>F04</b> , Ash wood stained WHITE <b>F05</b> , Ash wood stained CHERRY RED <b>F09</b> , Ash wood stained FLAMED WALNUT <b>F24</b> , Ash wood stained DARK BROWN <b>F26</b> , Ash wood stained NATURAL <b>F40</b> , Ash wood stained NATURAL OAK <b>F52</b> , Ash wood stained WHITENED <b>F60</b> , Ash wood stained DESERT <b>F61</b> , Ash wood stained LIGHT GREY <b>F62</b> , Ash wood stained DARK GREY <b>F63</b>       |
| <b>LII</b> | Veneered wood painted BLACK <b>I04</b> , Veneered wood painted WHITE <b>I05</b> , Veneered wood painted CHERRY RED <b>I09</b> , Veneered wood painted DARK BROWN <b>I26</b> , Veneered wood painted NATURAL <b>I40</b> , Veneered wood painted NATURAL OAK <b>I52</b> , Veneered wood painted WHITENED <b>I60</b> , Veneered wood painted DESERT <b>I61</b> , Veneered wood painted LIGHT GREY <b>I62</b> , Veneered wood painted DARK GREY <b>I63</b> |

**Shell finishes**

**Polypropylene**



|            |  |
|------------|--|
| <b>PPI</b> | WHITE <b>PB4</b> , GRAFITE GREY <b>PGD</b> , SKY GREY <b>PGU</b> , BROWN <b>PM2</b> , BLACK <b>PN4</b> , OCHER YELLOW <b>PO2</b> , RED <b>PRR</b> , RED BULGARO <b>PRS</b> , SAND <b>PS2</b> , TERRACOTTA <b>PT2</b> , DARK GREEN <b>PVL</b> |
|------------|--|

**Seat finishes**

**Upholstery**

|           |  |
|-----------|--|
| <b>TA</b> | FAUX LEATHER <b>Secret</b> , FABRIC <b>Mirage</b> , FABRIC <b>Cotton Club</b> , FABRIC <b>Renewed Loop</b>   |
| <b>TB</b> | FAUX LEATHER <b>Vintage</b> , FABRIC <b>Fenix Wool</b> , FABRIC <b>Visual</b> , FABRIC <b>Manhattan</b> , FABRIC <b>Novabuk</b> , FABRIC <b>Network</b> , FABRIC <b>Gyre</b>   |
| <b>TC</b> | VELVET SUPERB, FABRIC <b>Second</b> , FABRIC <b>Main Line Flax</b> , FABRIC <b>Oceanic</b> , FABRIC <b>Jumper</b> , FABRIC <b>Flame</b> , FABRIC <b>Ouche</b> , FABRIC <b>Plain</b> , FABRIC <b>Gemma</b> , FABRIC <b>Callagiron 114</b> |
| <b>TD</b> | FABRIC <b>Yoredale</b> , FABRIC <b>Remix 3</b>   |
| <b>TE</b> | FABRIC <b>Uniform Melange</b>  |
| <b>SF</b> | LEATHER <b>Fiore</b>   |
| <b>SV</b> | LEATHER <b>Vintage</b>   |

**COM/COL - Minimum Q.ty 6 pc. for each material. For weft or patterned fabrics see specific pages**

|   |                        |  |               |
|---|------------------------|--|---------------|
|  <b>COM</b> | Mtl. 0.60 h. 1.40 Each |  <b>COL</b> | Mq. 0.70 Each |
|---|------------------------|--|---------------|

**Optionals:**

|              |                          | Value   | Options/notes  |
|--------------|--------------------------|---------|--|
| <b>FM-M2</b> | Indoor matt metal M2     | + 48 €  | ASH GREY <b>ES</b> , BLUE SAPPHIRE <b>EE</b> , BLUE TURQUOISE <b>EH</b> , BRONZE <b>E2</b> , BULGARO RED <b>FP</b> , CHERRY RED <b>EQ</b> , DARK GREEN <b>EL</b> , FACEPOWDER PINK <b>E8</b> , FANGO <b>E3</b> , GOLDEN YELLOW <b>EO</b> , LIGHT BLUE <b>EO</b> , LIGHT GREY <b>ET</b> , OCEAN BLUE <b>EI</b> , OCHER YELLOW <b>E7</b> , PAPAYA ORANGE <b>EA</b> , PASTEL YELLOW <b>E4</b> , PINE GREEN <b>EJ</b> , RED <b>ER</b> , SAGE GREEN <b>E9</b> |
| <b>FM-M3</b> | Indoor glossy metal M3   | + 21 €  | CHROME <b>CC</b>   |
| <b>FM-M4</b> | Indoor glossy Metal M4   | + 123 € | BLACK NICKEL <b>DZ</b> , CHAMPAGNE GOLD <b>DG</b> , GOLDEN BRONZE <b>DB</b> , MATT BLACK NICKEL <b>DY</b> , MATT GOLDEN BRONZE <b>DC</b> , PINK GOLD <b>DR</b>   |
| <b>FL-I2</b> | Veneered wood finish LI2 | + 6 €   | Veneered wood FLAMED WALNUT <b>I24</b> , Veneered wood NATURAL OAK <b>I22</b>  |
| <b>ES-1</b>  | Fireproof foam           | + 5 €   | ES-1   |
| <b>PD-F0</b> | Felt pad feet            | + 6 €   | PD-F0  |

**Calla P\_M**

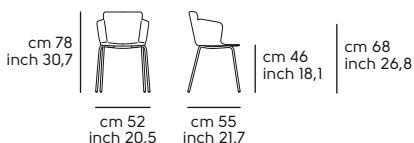

**Calla P\_T**

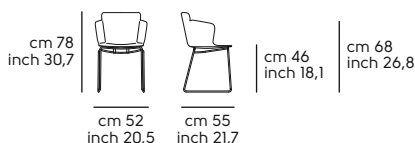

**Calla P\_Q**

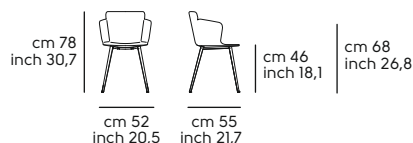

**Calla P\_X**

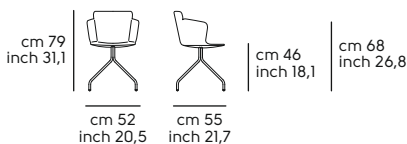

**Calla P\_C**

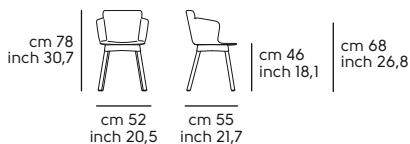

**Calla P\_N**

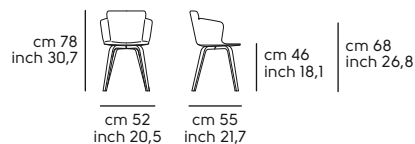



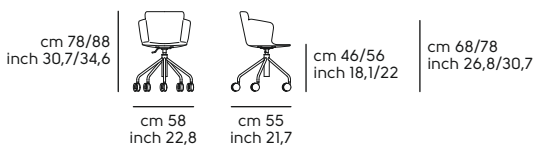





**Calla P\_DP**



**Calla P, DP - Shell in fabric or leather**

Frame in: metal or wood

| Model  | Code      | Base type | Frame | Upholstered shell |       |       |       |       |       |       |       |       | Optional                                 | Q.ty | boxes | Kg  | M <sup>3</sup> |
|--|-----------|-----------|-------|-------------------|-------|-------|-------|-------|-------|-------|-------|-------|--|------|-------|-----|----------------|
|  |           |           |       | TA                | TB    | TC    | TD    | TE    | SF    | SV    | COM   | COL   |  |      |       |     |                |
| <b>Armchair CALLA P M_M TS</b><br>  | S192IPT_M | _M        | MI    | 349 €             | 383 € | 434 € | 467 € | 626 € | 464 € | 540 € | 356 € | 434 € | FM-M2<br>FM-M3<br>FM-M4<br>ES-1<br>PD-FO | 1    | 1     | 7.5 | 0.26           |
| <b>Armchair CALLA P M_T TS</b><br>  | S192IPT_T | _T        | MI    | 374 €             | 408 € | 459 € | 492 € | 651 € | 489 € | 565 € | 381 € | 459 € | FM-M2<br>ES-1                            | 1    | 1     | 7.5 | 0.26           |
| <b>Armchair CALLA P M_Q TS</b><br>  | S192IPT_Q | _Q        | MI    | 386 €             | 420 € | 471 € | 504 € | 663 € | 501 € | 577 € | 393 € | 471 € | FM-M2<br>ES-1<br>PD-FO                   | 1    | 1     | 7.5 | 0.26           |
| <b>Armchair CALLA P M_X TS</b><br>   | S192IPT_X | _X        | MI    | 369 €             | 403 € | 454 € | 487 € | 646 € | 484 € | 560 € | 376 € | 454 € | FM-M2<br>FM-M3<br>FM-M4<br>ES-1<br>PD-FO | 1    | 1     | 7.5 | 0.26           |
| <b>Armchair CALLA P L_C TS</b><br>  | S1926WT_C | _C        | LF1   | 434 €             | 469 € | 518 € | 553 € | 713 € | 551 € | 626 € | 442 € | 518 € | ES-1<br>PD-FO                            | 1    | 1     | 7.5 | 0.26           |
| <b>Armchair CALLA P L_N TS</b><br>  | S1926WT_N | _N        | LII   | 522 €             | 557 € | 606 € | 641 € | 801 € | 639 € | 714 € | 530 € | 606 € | FL-I2<br>ES-1<br>PD-FO                   | 1    | 1     | 7.5 | 0.26           |
| <b>Office Arm. CALLA DP TS</b><br><br> | S1921DT   | DP        | MI    | 529 €             | 565 € | 617 € | 650 € | 809 € | 647 € | 723 € | 539 € | 617 € | FM-M2<br>FM-M3<br>ES-1                   | 1    | 2     | 10  | 0.29           |

**Note:**

TS Front and Back covering available in two-tone or bi-material. Reference price in the upper category. Linking device available for T base. See Accessories section



**Frame finishes**

| Metal     |   | Wood       |  |
|-----------|---|------------|--|
| <b>MI</b> | WHITE <b>BB</b> , BROWN <b>E6</b> , SAND <b>EC</b> , WHITE PEARL <b>EF</b> , GRAPHITE <b>EG</b> , BLACK <b>EN</b> | <b>LFI</b> | Ash wood stained BLACK <b>F04</b> , Ash wood stained WHITE <b>F05</b> , Ash wood stained CHERRY RED <b>F09</b> , Ash wood stained FLAMED WALNUT <b>F24</b> , Ash wood stained DARK BROWN <b>F26</b> , Ash wood stained NATURAL <b>F40</b> , Ash wood stained NATURAL OAK <b>F52</b> , Ash wood stained WHITENED <b>F60</b> , Ash wood stained DESERT <b>F61</b> , Ash wood stained LIGHT GREY <b>F62</b> , Ash wood stained DARK GREY <b>F63</b>       |
|           |   | <b>LII</b> | Veneered wood painted BLACK <b>I04</b> , Veneered wood painted WHITE <b>I05</b> , Veneered wood painted CHERRY RED <b>I09</b> , Veneered wood painted DARK BROWN <b>I26</b> , Veneered wood painted NATURAL <b>I40</b> , Veneered wood painted NATURAL OAK <b>I52</b> , Veneered wood painted WHITENED <b>I60</b> , Veneered wood painted DESERT <b>I61</b> , Veneered wood painted LIGHT GREY <b>I62</b> , Veneered wood painted DARK GREY <b>I63</b> |

**Shell finishes**

| Upholstery |   |
|------------|---|
| <b>TA</b>  | FAUX LEATHER <b>Secret</b> , FABRIC <b>Mirage</b> , FABRIC <b>Cotton Club</b> , FABRIC <b>Renewed Loop</b>  |
| <b>TC</b>  | VELVET SUPERB, FABRIC <b>Second</b> , FABRIC <b>Main Line Flax</b> , FABRIC <b>Oceanic</b> , FABRIC <b>Jumper</b> , FABRIC <b>Flame</b> , FABRIC <b>Ouche</b> , FABRIC <b>Plain</b> , FABRIC <b>Gemma</b> , FABRIC <b>Callagirone 114</b> |
| <b>TE</b>  | FABRIC <b>Uniform Melange</b>   |
| <b>SV</b>  | LEATHER <b>Vintage</b>  |
| <b>TB</b>  | FAUX LEATHER <b>Vintage</b> , FABRIC <b>Fenix Wool</b> , FABRIC <b>Visual</b> , FABRIC <b>Manhattan</b> , FABRIC <b>Novabuk</b> , FABRIC <b>Network</b> , FABRIC <b>Gyre</b>  |
| <b>TD</b>  | FABRIC <b>Yoredale</b> , FABRIC <b>Remix 3</b>  |
| <b>SF</b>  | LEATHER <b>Fiore</b>  |

**COM/COL - Minimum Q.ty 6 pc. for each material. For weft or patterned fabrics see specific pages**

|  |                        |   |               |
|--|------------------------|---|---------------|
|  <b>COM</b> | Mtl. 1.10 h. 1.40 Each |  <b>COL</b> | Mq. 2.40 Each |
|--|------------------------|---|---------------|

**Optionals:**

|              |                          | Value   | Options/notes  |
|--------------|--------------------------|---------|--|
| <b>FM-M2</b> | Indoor matt metal M2     | + 48 €  | ASH GREY <b>ES</b> , BLUE SAPPHIRE <b>EE</b> , BLUE TURQUOISE <b>EH</b> , BRONZE <b>E2</b> , BULGARO RED <b>FP</b> , CHERRY RED <b>EQ</b> , DARK GREEN <b>EL</b> , FACEPOWDER PINK <b>E8</b> , FANGO <b>E3</b> , GOLDEN YELLOW <b>EO</b> , LIGHT BLUE <b>EO</b> , LIGHT GREY <b>ET</b> , OCEAN BLUE <b>E1</b> , OCHER YELLOW <b>E7</b> , PAPAYA ORANGE <b>EA</b> , PASTEL YELLOW <b>E4</b> , PINE GREEN <b>EJ</b> , RED <b>ER</b> , SAGE GREEN <b>E9</b> |
| <b>FM-M3</b> | Indoor glossy metal M3   | + 21 €  | CHROME <b>CC</b>   |
| <b>FM-M4</b> | Indoor glossy Metal M4   | + 123 € | BLACK NICKEL <b>DZ</b> , CHAMPAGNE GOLD <b>DG</b> , GOLDEN BRONZE <b>DB</b> , MATT BLACK NICKEL <b>DY</b> , MATT GOLDEN BRONZE <b>DC</b> , PINK GOLD <b>DR</b>   |
| <b>FL-I2</b> | Veneered wood finish LI2 | + 6 €   | Veneered wood FLAMED WALNUT <b>I24</b> , Veneered wood NATURAL OAK <b>I22</b>  |
| <b>ES-1</b>  | Fireproof foam           | + 6 €   | ES-1   |
| <b>PD-F0</b> | Felt pad feet            | + 6 €   | PD-F0  |

**Calla P\_M**



**Calla P\_T**

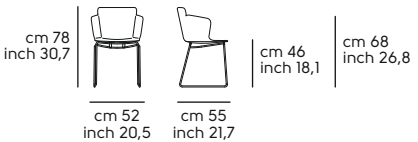

**Calla P\_Q**

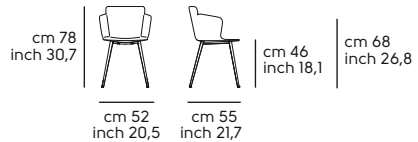

**Calla P\_X**

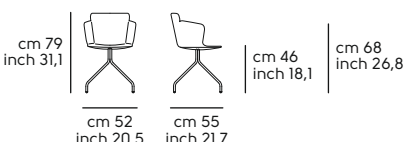

**Calla P\_C**

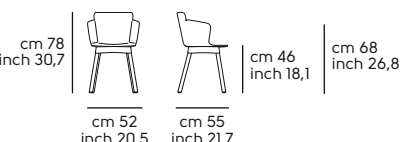

**Calla P\_N**

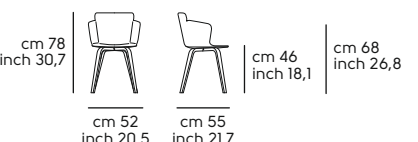



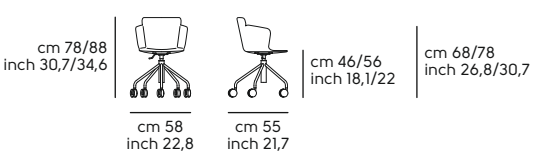

**Calla P\_DP**



**Calla S H65-S H75 - Shell in polypropylene, seat in fabric or leather, shell in fabric or leather**

Frame in: metal

| Model  | Code    | Mod. | Frame | Shell |  |  |  |  |  |  |  |  | Optional                         | Q.ty | boxes | Kg | M <sup>3</sup> |
|--|---------|------|-------|-------|--|--|--|--|--|--|--|--|----------------------------------|------|-------|----|----------------|
| PP1  |         |      |       |       |  |  |  |  |  |  |  |  |                                  |      |       |    |                |
| <b>Stool CALLA S65 M PP</b><br> | S1920HP | S65  | M1    | 277 € |  |  |  |  |  |  |  |  | FM-M2<br>FM-O1<br>FM-O2<br>PD-F0 | 1    | 1     | 7  | 0.23           |
| <b>Stool CALLA S75 M PP</b><br> | S1920JP | S75  | M1    | 292 € |  |  |  |  |  |  |  |  | FM-M2<br>FM-O1<br>FM-O2<br>PD-F0 | 1    | 1     | 7  | 0.25           |

| Model   | Code    | Mod. | Frame | Shell PP1 / Seat |       |       |       |       |       |       |       |       | Optional               | Q.ty | boxes | Kg | M <sup>3</sup> |
|---|---------|------|-------|------------------|-------|-------|-------|-------|-------|-------|-------|-------|------------------------|------|-------|----|----------------|
|   |         |      |       | TA               | TB    | TC    | TD    | TE    | SF    | SV    | COM   | COL   |                        |      |       |    |                |
| <b>Stool CALLA S65 M PP_TS</b><br>  | S1920HS | S65  | M1    | 334 €            | 348 € | 362 € | 400 € | 510 € | 374 € | 416 € | 341 € | 362 € | FM-M2<br>ES-1<br>PD-F0 | 1    | 1     | 7  | 0.23           |
| <b>Stool CALLA S75 M PP_TS</b><br> | S1920JS | S75  | M1    | 346 €            | 362 € | 374 € | 414 € | 524 € | 388 € | 431 € | 353 € | 374 € | FM-M2<br>ES-1<br>PD-F0 | 1    | 1     | 7  | 0.25           |

| Model  | Code    | Mod. | Frame | Upholstered shell |       |       |       |       |       |       |       |       | Optional               | Q.ty | boxes | Kg  | M <sup>3</sup> |
|--|---------|------|-------|-------------------|-------|-------|-------|-------|-------|-------|-------|-------|------------------------|------|-------|-----|----------------|
|  |         |      |       | TA                | TB    | TC    | TD    | TE    | SF    | SV    | COM   | COL   |                        |      |       |     |                |
| <b>Stool CALLA S65 M TS</b><br> | S1920HT | S65  | M1    | 368 €             | 396 € | 438 € | 465 € | 622 € | 484 € | 548 € | 374 € | 438 € | FM-M2<br>ES-1<br>PD-F0 | 1    | 1     | 7.5 | 0.23           |
| <b>Stool CALLA S75 M TS</b><br> | S1920JT | S75  | M1    | 381 €             | 410 € | 453 € | 477 € | 634 € | 495 € | 562 € | 388 € | 453 € | FM-M2<br>ES-1<br>PD-F0 | 1    | 1     | 7.5 | 0.25           |

**Note:**

TS Front and Back covering available in two-tone or bi-material. Reference price in the upper category

**Frame finishes**

|              |   |
|--------------|---|
| <b>Metal</b> |   |
| <b>MI</b>    | WHITE <b>BB</b> , BROWN <b>E6</b> , SAND <b>EC</b> , WHITE PEARL <b>EF</b> , GRAPHITE <b>EG</b> , BLACK <b>EN</b> |



**Shell finishes**

|                      |  |
|----------------------|--|
| <b>Polypropylene</b> |  |
| <b>PPI</b>           | WHITE <b>PB4</b> , GRAFITE GREY <b>PGD</b> , SKY GREY <b>PGU</b> , BROWN <b>PM2</b> , BLACK <b>PN4</b> , OCHER YELLOW <b>PO2</b> , RED <b>PRR</b> , RED BULGARO <b>PRS</b> , SAND <b>PS2</b> , TERRACOTTA <b>PT2</b> , DARK GREEN <b>PVL</b> |

**Seat and shell finishes**

|                   |   |           |  |
|-------------------|---|-----------|--|
| <b>Upholstery</b> |   |           |  |
| <b>TA</b>         | FAUX LEATHER <b>Secret</b> , FABRIC <b>Mirage</b> , FABRIC <b>Cotton Club</b> , FABRIC <b>Renewed Loop</b>  | <b>TB</b> | FAUX LEATHER <b>Vintage</b> , FABRIC <b>Fenix Wool</b> , FABRIC <b>Visual</b> , FABRIC <b>Manhattan</b> , FABRIC <b>Novabuk</b> , FABRIC <b>Network</b> , FABRIC <b>Gyre</b> |
| <b>TC</b>         | VELVET SUPERB, FABRIC <b>Second</b> , FABRIC <b>Main Line Flax</b> , FABRIC <b>Oceanic</b> , FABRIC <b>Jumper</b> , FABRIC <b>Flame</b> , FABRIC <b>Ouche</b> , FABRIC <b>Plain</b> , FABRIC <b>Gemma</b> , FABRIC <b>Caltagirone 114</b> | <b>TD</b> | FABRIC <b>Yoredale</b> , FABRIC <b>Remix 3</b>   |
| <b>TE</b>         | FABRIC <b>Uniform Melange</b>   | <b>SF</b> | LEATHER <b>Fiore</b>   |
| <b>SV</b>         | LEATHER <b>Vintage</b>  |           |  |

**COM/COL - Minimum Q.ty 6 pc. for each material. For weft or patterned fabrics see specific pages**

|  |  |   |  |
|--|--|---|--|
|  | M PP_TS Mtl. 0.60 h. 1.40 Each - M TS Mtl. 0.92 h. 1.40 Each |  | M PP_TS Mq. 0.70 Each - M TS Mq. 1.90 Each |
|--|--|---|--|

**Optionals:**

|              |                      | Value  | Options/notes  |
|--------------|----------------------|--------|--|
| <b>FM-M2</b> | Indoor matt metal M2 | + 48 € | ASH GREY <b>ES</b> , BLUE SAPPHIRE <b>EE</b> , BLUE TURQUOISE <b>EH</b> , BRONZE <b>E2</b> , BULGARO RED <b>FP</b> , CHERRY RED <b>EQ</b> , DARK GREEN <b>EL</b> , FACEPOWDER PINK <b>E8</b> , FANGO <b>E3</b> , GOLDEN YELLOW <b>EO</b> , LIGHT BLUE <b>EO</b> , LIGHT GREY <b>ET</b> , OCEAN BLUE <b>E1</b> , OCHER YELLOW <b>E7</b> , PAPAYA ORANGE <b>EA</b> , PASTEL YELLOW <b>E4</b> , PINE GREEN <b>EJ</b> , RED <b>ER</b> , SAGE GREEN <b>E9</b>   |
| <b>FM-O1</b> | Outdoor metal O1     | + 42 € | Outdoor BLACK <b>EN</b> , Outdoor BROWN <b>E6</b> , Outdoor GRAFITE <b>EG</b> , Outdoor SAND <b>EC</b> , Outdoor WHITE PEARL <b>EF</b> , Outdoor WHITE <b>BB</b>   |
| <b>FM-O2</b> | Outdoor metal O2     | + 96 € | Outdoor ASH GREY <b>ES</b> , Outdoor BLUE SAPPHIRE <b>EE</b> , Outdoor BLUE TURQUOISE <b>EH</b> , Outdoor BRONZE <b>E2</b> , Outdoor CHERRY RED <b>EQ</b> , Outdoor DARK GREEN <b>EL</b> , Outdoor FACEPOWDER PINK <b>E8</b> , Outdoor FANGO <b>E3</b> , Outdoor GOLD YELLOW <b>EO</b> , Outdoor LIGHT BLUE <b>EO</b> , Outdoor LIGHT GREY <b>ET</b> , Outdoor OCEAN BLUE <b>E1</b> , Outdoor OCHER YELLOW <b>E7</b> , Outdoor PAPAYA ORANGE <b>EA</b> , Outdoor PASTEL YELLOW <b>E4</b> , Outdoor PINE GREEN <b>EJ</b> , Outdoor RED BULGARO <b>FP</b> , Outdoor RED <b>ER</b> , Outdoor SAGE GREEN <b>E9</b> |
| <b>ES-1</b>  | Fireproof foam       | + 5 €  | ES-1   |
| <b>PD-F0</b> | Felt pad feet        | + 6 €  | PD-F0  |

**Calla S65**

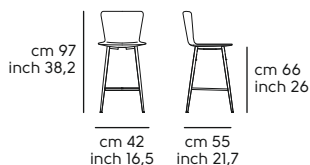



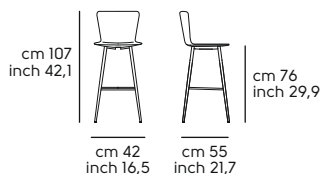

**Calla S75**





**Calla P H65-P H75 - Shell in polypropylene, seat in fabric or leather, shell in fabric or leather**

Frame in: metal

| Model  | Code    | Mod. | Frame | Shell |  |  |  |  |  |  |  |  | Optional                         | Q.ty | boxes | Kg | M <sup>3</sup> |
|--|---------|------|-------|-------|--|--|--|--|--|--|--|--|----------------------------------|------|-------|----|----------------|
| PP1  |         |      |       |       |  |  |  |  |  |  |  |  |                                  |      |       |    |                |
| <b>Stool CALLA P65 M PP</b><br> | S1921HP | P65  | M1    | 297 € |  |  |  |  |  |  |  |  | FM-M2<br>FM-O1<br>FM-O2<br>PD-F0 | 1    | 1     | 7  | 0.27           |
| <b>Stool CALLA P75 M PP</b><br> | S1921JP | P75  | M1    | 310 € |  |  |  |  |  |  |  |  | FM-M2<br>FM-O1<br>FM-O2<br>PD-F0 | 1    | 1     | 7  | 0.30           |

| Model   | Code    | Mod. | Frame | Shell PP1 / Seat |       |       |       |       |       |       |       |       | Optional               | Q.ty | boxes | Kg | M <sup>3</sup> |
|---|---------|------|-------|------------------|-------|-------|-------|-------|-------|-------|-------|-------|------------------------|------|-------|----|----------------|
|   |         |      |       | TA               | TB    | TC    | TD    | TE    | SF    | SV    | COM   | COL   |                        |      |       |    |                |
| <b>Stool CALLA P65 M PP_TS</b><br>  | S1921HS | P65  | M1    | 354 €            | 368 € | 383 € | 420 € | 526 € | 394 € | 437 € | 361 € | 383 € | FM-M2<br>ES-1<br>PD-F0 | 1    | 1     | 7  | 0.27           |
| <b>Stool CALLA P75 M PP_TS</b><br> | S1921JS | P75  | M1    | 367 €            | 383 € | 394 € | 435 € | 539 € | 409 € | 452 € | 373 € | 394 € | FM-M2<br>ES-1<br>PD-F0 | 1    | 1     | 7  | 0.30           |

| Model  | Code    | Mod. | Frame | Upholstered shell |       |       |       |       |       |       |       |       | Optional               | Q.ty | boxes | Kg  | M <sup>3</sup> |
|--|---------|------|-------|-------------------|-------|-------|-------|-------|-------|-------|-------|-------|------------------------|------|-------|-----|----------------|
|  |         |      |       | TA                | TB    | TC    | TD    | TE    | SF    | SV    | COM   | COL   |                        |      |       |     |                |
| <b>Stool CALLA P65 M TS</b><br> | S1921HT | P65  | M1    | 457 €             | 493 € | 546 € | 575 € | 735 € | 573 € | 649 € | 465 € | 546 € | FM-M2<br>ES-1<br>PD-F0 | 1    | 1     | 7.5 | 0.27           |
| <b>Stool CALLA P75 M TS</b><br> | S1921JT | P75  | M1    | 470 €             | 509 € | 558 € | 591 € | 750 € | 588 € | 664 € | 479 € | 558 € | FM-M2<br>ES-1<br>PD-F0 | 1    | 1     | 7.5 | 0.30           |

**Note:**

TS Front and Back covering available in two-tone or bi-material. Reference price in the upper category

**Frame finishes**

|              |   |
|--------------|---|
| <b>Metal</b> |   |
| <b>MI</b>    | WHITE <b>BB</b> , BROWN <b>E6</b> , SAND <b>EC</b> , WHITE PEARL <b>EF</b> , GRAPHITE <b>EG</b> , BLACK <b>EN</b> |



**Shell finishes**

|                      |  |
|----------------------|--|
| <b>Polypropylene</b> |  |
| <b>PPI</b>           | WHITE <b>PB4</b> , GRAFITE GREY <b>PGD</b> , SKY GREY <b>PGU</b> , BROWN <b>PM2</b> , BLACK <b>PN4</b> , OCHER YELLOW <b>PO2</b> , RED <b>PRR</b> , RED BULGARO <b>PRS</b> , SAND <b>PS2</b> , TERRACOTTA <b>PT2</b> , DARK GREEN <b>PVL</b> |

**Seat and shell finishes**

|                   |   |           |  |
|-------------------|---|-----------|--|
| <b>Upholstery</b> |   |           |  |
| <b>TA</b>         | FAUX LEATHER <b>Secret</b> , FABRIC <b>Mirage</b> , FABRIC <b>Cotton Club</b> , FABRIC <b>Renewed Loop</b>  | <b>TB</b> | FAUX LEATHER <b>Vintage</b> , FABRIC <b>Fenix Wool</b> , FABRIC <b>Visual</b> , FABRIC <b>Manhattan</b> , FABRIC <b>Novabuk</b> , FABRIC <b>Network</b> , FABRIC <b>Gyre</b> |
| <b>TC</b>         | VELVET SUPERB, FABRIC <b>Second</b> , FABRIC <b>Main Line Flax</b> , FABRIC <b>Oceanic</b> , FABRIC <b>Jumper</b> , FABRIC <b>Flame</b> , FABRIC <b>Ouche</b> , FABRIC <b>Plain</b> , FABRIC <b>Gemma</b> , FABRIC <b>Caltagirone 114</b> | <b>TD</b> | FABRIC <b>Yoredale</b> , FABRIC <b>Remix 3</b>   |
| <b>TE</b>         | FABRIC <b>Uniform Melange</b>   | <b>SF</b> | LEATHER <b>Fiore</b>   |
| <b>SV</b>         | LEATHER <b>Vintage</b>  |           |  |

**COM/COL - Minimum Q.ty 6 pc. for each material. For weft or patterned fabrics see specific pages**

|  |  |   |  |
|--|--|---|--|
|  | M PP_TS Mtl. 0.60 h. 1.40 Each - M TS Mtl. 1.10 h. 1.40 Each |  | M PP_TS Mq. 0.70 Each - M TS Mq. 2.40 Each |
|--|--|---|--|

**Optionals:**

|              |                      | Value  | Options/notes  |
|--------------|----------------------|--------|--|
| <b>FM-M2</b> | Indoor matt metal M2 | + 48 € | ASH GREY <b>ES</b> , BLUE SAPPHIRE <b>EE</b> , BLUE TURQUOISE <b>EH</b> , BRONZE <b>E2</b> , BULGARO RED <b>FP</b> , CHERRY RED <b>EQ</b> , DARK GREEN <b>EL</b> , FACEPOWDER PINK <b>E8</b> , FANGO <b>E3</b> , GOLDEN YELLOW <b>EO</b> , LIGHT BLUE <b>EO</b> , LIGHT GREY <b>ET</b> , OCEAN BLUE <b>E1</b> , OCHER YELLOW <b>E7</b> , PAPAYA ORANGE <b>EA</b> , PASTEL YELLOW <b>E4</b> , PINE GREEN <b>EJ</b> , RED <b>ER</b> , SAGE GREEN <b>E9</b>   |
| <b>FM-O1</b> | Outdoor metal O1     | + 42 € | Outdoor BLACK <b>EN</b> , Outdoor BROWN <b>E6</b> , Outdoor GRAFITE <b>EG</b> , Outdoor SAND <b>EC</b> , Outdoor WHITE PEARL <b>EF</b> , Outdoor WHITE <b>BB</b>   |
| <b>FM-O2</b> | Outdoor metal O2     | + 96 € | Outdoor ASH GREY <b>ES</b> , Outdoor BLUE SAPPHIRE <b>EE</b> , Outdoor BLUE TURQUOISE <b>EH</b> , Outdoor BRONZE <b>E2</b> , Outdoor CHERRY RED <b>EQ</b> , Outdoor DARK GREEN <b>EL</b> , Outdoor FACEPOWDER PINK <b>E8</b> , Outdoor FANGO <b>E3</b> , Outdoor GOLD YELLOW <b>EO</b> , Outdoor LIGHT BLUE <b>EO</b> , Outdoor LIGHT GREY <b>ET</b> , Outdoor OCEAN BLUE <b>E1</b> , Outdoor OCHER YELLOW <b>E7</b> , Outdoor PAPAYA ORANGE <b>EA</b> , Outdoor PASTEL YELLOW <b>E4</b> , Outdoor PINE GREEN <b>EJ</b> , Outdoor RED BULGARO <b>FP</b> , Outdoor RED <b>ER</b> , Outdoor SAGE GREEN <b>E9</b> |
| <b>ES-1</b>  | Fireproof foam       | + 5 €  | ES-1   |
| <b>PD-F0</b> | Felt pad feet        | + 6 €  | PD-F0  |

**Calla P65**

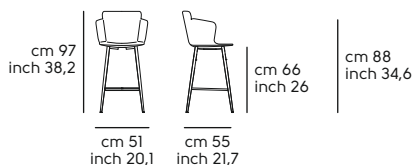



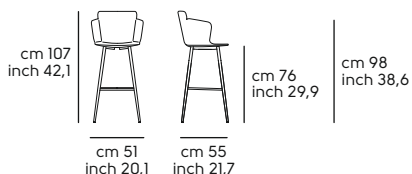

**Calla P75**





**Calla S H65-S H75 - Shell in polypropylene, seat in fabric or leather, shell in fabric or leather**

Frame in: wood

| Model   | Code    | Mod. | Frame | Shell |  |  |  |  |  |  |  | Optional | Q.ty | boxes | Kg  | M <sup>2</sup> |
|---|---------|------|-------|-------|--|--|--|--|--|--|--|----------|------|-------|-----|----------------|
|   |         |      |       | PP1   |  |  |  |  |  |  |  |          |      |       |     |                |
| <b>Stool CALLA S65 LR PP</b><br> | S1925HP | S65  | LF1   | 337 € |  |  |  |  |  |  |  | PD-F0    | 1    | 1     | 7.2 | 0.25           |
| <b>Stool CALLA S75 LR PP</b><br> | S1925JP | S75  | LF1   | 357 € |  |  |  |  |  |  |  | PD-F0    | 1    | 1     | 7.6 | 0.28           |

| Model  | Code    | Mod. | Frame | Shell PP1 / Seat |       |       |       |       |       |       |       |       | Optional      | Q.ty | boxes | Kg   | M <sup>2</sup> |
|--|---------|------|-------|------------------|-------|-------|-------|-------|-------|-------|-------|-------|---------------|------|-------|------|----------------|
|  |         |      |       | TA               | TB    | TC    | TD    | TE    | SF    | SV    | COM   | COL   |               |      |       |      |                |
| <b>Stool CALLA S65 LR PP_TS</b><br>  | S1925HS | S65  | LF1   | 394 €            | 410 € | 422 € | 462 € | 571 € | 437 € | 477 € | 401 € | 422 € | ES-1<br>PD-F0 | 1    | 1     | 8.1  | 0.25           |
| <b>Stool CALLA S75 LR PP_TS</b><br> | S1925JS | S75  | LF1   | 412 €            | 426 € | 442 € | 479 € | 589 € | 454 € | 496 € | 420 € | 442 € | ES-1<br>PD-F0 | 1    | 1     | 8.35 | 0.28           |

| Model   | Code    | Mod. | Frame | Upholstered shell |       |       |       |       |       |       |       |       | Optional      | Q.ty | boxes | Kg  | M <sup>2</sup> |
|---|---------|------|-------|-------------------|-------|-------|-------|-------|-------|-------|-------|-------|---------------|------|-------|-----|----------------|
|   |         |      |       | TA                | TB    | TC    | TD    | TE    | SF    | SV    | COM   | COL   |               |      |       |     |                |
| <b>Stool CALLA S65 LR TS</b><br> | S1925HT | S65  | LF1   | 428 €             | 458 € | 499 € | 527 € | 683 € | 546 € | 608 € | 437 € | 499 € | ES-1<br>PD-F0 | 1    | 1     | 8.6 | 0.25           |
| <b>Stool CALLA S75 LR TS</b><br> | S1925JT | S75  | LF1   | 445 €             | 476 € | 518 € | 545 € | 700 € | 562 € | 628 € | 454 € | 518 € | ES-1<br>PD-F0 | 1    | 1     | 8.8 | 0.28           |

**Note:**

TS Front and Back covering available in two-tone or bi-material. Reference price in the upper category

**Frame finishes**

**Wood**

|            |  |
|------------|--|
| <b>LFI</b> | Ash wood stained BLACK <b>F04</b> , Ash wood stained WHITE <b>F05</b> , Ash wood stained CHERRY RED <b>F09</b> , Ash wood stained FLAMED WALNUT <b>F24</b> , Ash wood stained DARK BROWN <b>F26</b> , Ash wood stained NATURAL <b>F40</b> , Ash wood stained NATURAL OAK <b>F52</b> , Ash wood stained WHITENED <b>F60</b> , Ash wood stained DESERT <b>F61</b> , Ash wood stained LIGHT GREY <b>F62</b> , Ash wood stained DARK GREY <b>F63</b> |
|------------|--|

**Shell finishes**

**Polypropylene**



|            |  |
|------------|--|
| <b>PPI</b> | WHITE <b>PB4</b> , GRAFITE GREY <b>PGD</b> , SKY GREY <b>PGU</b> , BROWN <b>PM2</b> , BLACK <b>PN4</b> , OCHER YELLOW <b>PO2</b> , RED <b>PRR</b> , RED BULGARO <b>PRS</b> , SAND <b>PS2</b> , TERRACOTTA <b>PT2</b> , DARK GREEN <b>PVL</b> |
|------------|--|

**Seat and shell finishes**

**Upholstery**

|           |   |           |  |
|-----------|---|-----------|--|
| <b>TA</b> | FAUX LEATHER <b>Secret</b> , FABRIC <b>Mirage</b> , FABRIC <b>Cotton Club</b> , FABRIC <b>Renewed Loop</b>  | <b>TB</b> | FAUX LEATHER <b>Vintage</b> , FABRIC <b>Fenix Wool</b> , FABRIC <b>Visual</b> , FABRIC <b>Manhattan</b> , FABRIC <b>Novabuk</b> , FABRIC <b>Network</b> , FABRIC <b>Gyre</b> |
| <b>TC</b> | VELVET SUPERB, FABRIC <b>Second</b> , FABRIC <b>Main Line Flax</b> , FABRIC <b>Oceanic</b> , FABRIC <b>Jumper</b> , FABRIC <b>Flame</b> , FABRIC <b>Ouche</b> , FABRIC <b>Plain</b> , FABRIC <b>Gemma</b> , FABRIC <b>Caltagirone 114</b> | <b>TD</b> | FABRIC <b>Yoredale</b> , FABRIC <b>Remix 3</b>   |
| <b>TE</b> | FABRIC <b>Uniform Melange</b>   | <b>SF</b> | LEATHER <b>Fiore</b>   |
| <b>SV</b> | LEATHER <b>Vintage</b>  |           |  |

**COM/COL - Minimum Q.ty 6 pc. for each material. For weft or patterned fabrics see specific pages**

|  |  |   |  |
|--|--|---|--|
|  | M PP_TS Mtl. 0.60 h. 1.40 Each - M TS Mtl. 0.92 h. 1.40 Each |  | M PP_TS Mq. 0.70 Each - M TS Mq. 1.90 Each |
|--|--|---|--|

**Optionals:**

|              |                | Value | Options/notes |
|--------------|----------------|-------|---------------|
| <b>ES-1</b>  | Fireproof foam | + 6 € | ES-1          |
| <b>PD-F0</b> | Felt pad feet  | + 6 € | PD-F0         |

**Calla S65 LR PP**

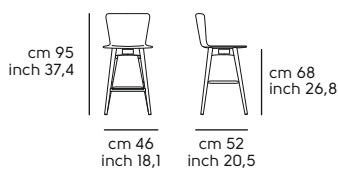

**Calla S75 LR PP**

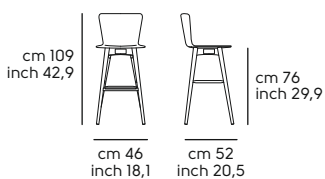

**Calla S65 LR PP\_TS**

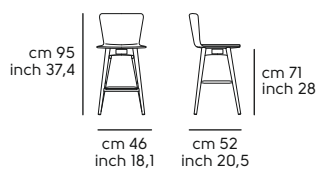

**Calla S75 LR PP\_TS**

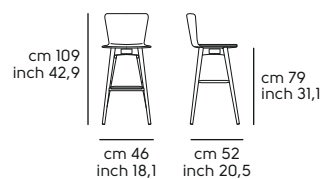

**Calla S65 LR TS**

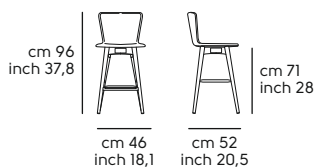



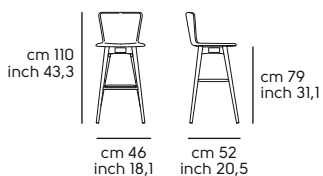

**Calla S75 LR TS**





**Calla P H65-P H75 - Shell in polypropylene, seat in fabric or leather, shell in fabric or leather**

Frame in: wood

| Model   | Code    | Mod. | Frame | Shell |  |  |  |  |  |  |  | Optional | Q.ty | boxes | Kg  | M <sup>3</sup> |
|---|---------|------|-------|-------|--|--|--|--|--|--|--|----------|------|-------|-----|----------------|
| PP1   |         |      |       |       |  |  |  |  |  |  |  |          |      |       |     |                |
| <b>Stool CALLA P65 LR PP</b><br> | S1926HP | P65  | LF1   | 358 € |  |  |  |  |  |  |  | PD-F0    | 1    | 1     | 7.6 | 0.31           |
| <b>Stool CALLA P75 LR PP</b><br> | S1926JP | P75  | LF1   | 376 € |  |  |  |  |  |  |  | PD-F0    | 1    | 1     | 7.9 | 0.33           |

| Model  | Code    | Mod. | Frame | Shell PP1 / Seat |       |       |       |       |       |       |       |       |               | Optional | Q.ty | boxes | Kg   | M <sup>3</sup> |
|--|---------|------|-------|------------------|-------|-------|-------|-------|-------|-------|-------|-------|---------------|----------|------|-------|------|----------------|
|  |         |      |       | TA               | TB    | TC    | TD    | TE    | SF    | SV    | COM   | COL   |               |          |      |       |      |                |
| <b>Stool CALLA P65 LR PP_TS</b><br>  | S1926HS | P65  | LF1   | 413 €            | 430 € | 443 € | 482 € | 587 € | 457 € | 498 € | 421 € | 443 € | ES-1<br>PD-F0 | 1        | 1    | 8     | 0.31 |                |
| <b>Stool CALLA P75 LR PP_TS</b><br> | S1926JS | P75  | LF1   | 433 €            | 447 € | 462 € | 500 € | 606 € | 475 € | 517 € | 441 € | 462 € | ES-1<br>PD-F0 | 1        | 1    | 8.4   | 0.33 |                |

| Model   | Code    | Mod. | Frame | Upholstered shell |       |       |       |       |       |       |       |       |               | Optional | Q.ty | boxes | Kg   | M <sup>3</sup> |
|---|---------|------|-------|-------------------|-------|-------|-------|-------|-------|-------|-------|-------|---------------|----------|------|-------|------|----------------|
|   |         |      |       | TA                | TB    | TC    | TD    | TE    | SF    | SV    | COM   | COL   |               |          |      |       |      |                |
| <b>Stool CALLA P65 LR TS</b><br> | S1926HT | P65  | LF1   | 517 €             | 554 € | 606 € | 638 € | 796 € | 634 € | 711 € | 527 € | 606 € | ES-1<br>PD-F0 | 1        | 1    | 8.45  | 0.31 |                |
| <b>Stool CALLA P75 LR TS</b><br> | S1926JT | P75  | LF1   | 537 €             | 574 € | 626 € | 656 € | 815 € | 654 € | 731 € | 547 € | 626 € | ES-1<br>PD-F0 | 1        | 1    | 8.8   | 0.33 |                |

**Note:**

TS Front and Back covering available in two-tone or bi-material. Reference price in the upper category

**Frame finishes**

**Wood**

**LFI**

Ash wood stained BLACK **F04**, Ash wood stained WHITE **F05**, Ash wood stained CHERRY RED **F09**, Ash wood stained FLAMED WALNUT **F24**, Ash wood stained DARK BROWN **F26**, Ash wood stained NATURAL **F40**, Ash wood stained NATURAL OAK **F52**, Ash wood stained WHITENED **F60**, Ash wood stained DESERT **F61**, Ash wood stained LIGHT GREY **F62**, Ash wood stained DARK GREY **F63**

**Shell finishes**

**Polypropylene**

**PPI**



WHITE **PB4**, GRAFITE GREY **PGD**, SKY GREY **PGU**, BROWN **PM2**, BLACK **PN4**, OCHER YELLOW **PO2**, RED **PRR**, RED BULGARO **PRS**, SAND **PS2**, TERRACOTTA **PT2**, DARK GREEN **PVL**

**Seat and shell finishes**

**Upholstery**

|           |   |           |  |
|-----------|---|-----------|--|
| <b>TA</b> | FAUX LEATHER <b>Secret</b> , FABRIC <b>Mirage</b> , FABRIC <b>Cotton Club</b> , FABRIC <b>Renewed Loop</b>  | <b>TB</b> | FAUX LEATHER <b>Vintage</b> , FABRIC <b>Fenix Wool</b> , FABRIC <b>Visual</b> , FABRIC <b>Manhattan</b> , FABRIC <b>Novabuk</b> , FABRIC <b>Network</b> , FABRIC <b>Gyre</b> |
| <b>TC</b> | VELVET SUPERB, FABRIC <b>Second</b> , FABRIC <b>Main Line Flax</b> , FABRIC <b>Oceanic</b> , FABRIC <b>Jumper</b> , FABRIC <b>Flame</b> , FABRIC <b>Ouche</b> , FABRIC <b>Plain</b> , FABRIC <b>Gemma</b> , FABRIC <b>Caltagirone 114</b> | <b>TD</b> | FABRIC <b>Yoredale</b> , FABRIC <b>Remix 3</b>   |
| <b>TE</b> | FABRIC <b>Uniform Melange</b>   | <b>SF</b> | LEATHER <b>Fiore</b>   |
| <b>SV</b> | LEATHER <b>Vintage</b>  |           |  |

**COM/COL - Minimum Q.ty 6 pc. for each material. For weft or patterned fabrics see specific pages**

|  |  |   |  |
|--|--|---|--|
|  | M PP_TS Mtl. 0.60 h. 1.40 Each - M TS Mtl. 1.10 h. 1.40 Each |  | M PP_TS Mq. 0.70 Each - M TS Mq. 2.40 Each |
|--|--|---|--|

**Optionals:**

|              | Value          | Options/notes |
|--------------|----------------|---------------|
| <b>ES-1</b>  | Fireproof foam | + 6 € ES-1    |
| <b>PD-F0</b> | Felt pad feet  | + 6 € PD-F0   |

**Calla P65 LR PP**

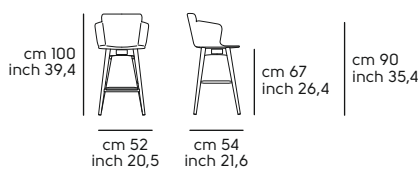

**Calla P75 LR PP**

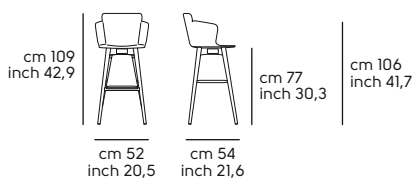

**Calla P65 LR PP\_TS**

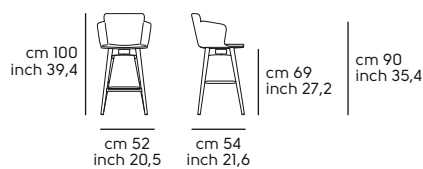

**Calla P75 LR PP\_TS**

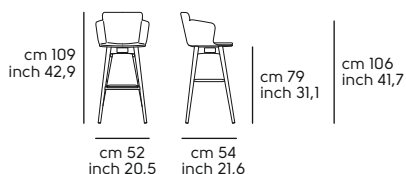

**Calla P65 LR TS**

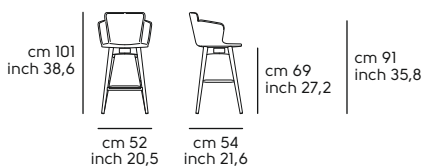



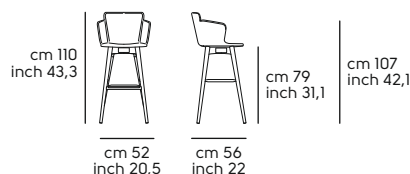

**Calla P75 LR TS**





**Calla SG - Shell in polypropylene, seat in fabric or leather, shell in fabric or leather**

Frame in: metal

| Model   | Code    | Mod. | Frame | Shell |  |  |  |  |  |  |  | Optional | Q.ty | boxes | Kg   | M <sup>3</sup> |
|---|---------|------|-------|-------|--|--|--|--|--|--|--|----------|------|-------|------|----------------|
| PPI   |         |      |       |       |  |  |  |  |  |  |  |          |      |       |      |                |
| <b>Stool CALLA S SG PP</b><br> | S1920ZP | S    | M1    | 506 € |  |  |  |  |  |  |  | FM-M2    | 1    | 1     | 16.6 | 0.26           |
| <b>Stool CALLA P SG PP</b><br> | S1921ZP | P    | M1    | 537 € |  |  |  |  |  |  |  | FM-M2    | 1    | 1     | 17   | 0.30           |

| Model  | Code    | Mod. | Frame | Shell PPI / Seat |       |       |       |       |       |       |       | Optional | Q.ty          | boxes | Kg | M <sup>3</sup> |      |
|--|---------|------|-------|------------------|-------|-------|-------|-------|-------|-------|-------|----------|---------------|-------|----|----------------|------|
|  |         |      |       | TA               | TB    | TC    | TD    | TE    | SF    | SV    | COM   | COL      |               |       |    |                |      |
| <b>Stool CALLA S SG PP_TS</b><br>  | S1920ZS | S    | M1    | 564 €            | 582 € | 595 € | 634 € | 743 € | 608 € | 649 € | 574 € | 595 €    | FM-M2<br>ES-1 | 1     | 1  | 17             | 0.26 |
| <b>Stool CALLA P SG PP_TS</b><br> | S1921ZS | P    | M1    | 583 €            | 602 € | 617 € | 654 € | 759 € | 628 € | 670 € | 594 € | 617 €    | FM-M2<br>ES-1 | 1     | 1  | 17.4           | 0.30 |

| Model   | Code    | Mod. | Frame | Upholstered shell |       |       |       |       |       |       |       | Optional | Q.ty          | boxes | Kg | M <sup>3</sup> |      |
|---|---------|------|-------|-------------------|-------|-------|-------|-------|-------|-------|-------|----------|---------------|-------|----|----------------|------|
|   |         |      |       | TA                | TB    | TC    | TD    | TE    | SF    | SV    | COM   | COL      |               |       |    |                |      |
| <b>Stool CALLA S SG TS</b><br> | S1920ZT | S    | M1    | 597 €             | 629 € | 672 € | 699 € | 856 € | 718 € | 782 € | 608 € | 672 €    | FM-M2<br>ES-1 | 1     | 1  | 17.5           | 0.26 |
| <b>Stool CALLA P SG TS</b><br> | S1921ZT | P    | M1    | 685 €             | 727 € | 779 € | 809 € | 969 € | 807 € | 883 € | 699 € | 779 €    | FM-M2<br>ES-1 | 1     | 1  | 17.9           | 0.30 |

**Note:**

TS Front and Back covering available in two-tone or bi-material. Reference price in the upper category

**Frame finishes**

|              |   |
|--------------|---|
| <b>Metal</b> |   |
| <b>MI</b>    | WHITE <b>BB</b> , BROWN <b>E6</b> , SAND <b>EC</b> , WHITE PEARL <b>EF</b> , GRAPHITE <b>EG</b> , BLACK <b>EN</b> |



**Shell finishes**

|                      |  |
|----------------------|--|
| <b>Polypropylene</b> |  |
| <b>PPI</b>           | WHITE <b>PB4</b> , GRAFITE GREY <b>PGD</b> , SKY GREY <b>PGU</b> , BROWN <b>PM2</b> , BLACK <b>PN4</b> , OCHER YELLOW <b>PO2</b> , RED <b>PRR</b> , RED BULGARO <b>PRS</b> , SAND <b>PS2</b> , TERRACOTTA <b>PT2</b> , DARK GREEN <b>PVL</b> |



**Seat and shell finishes**

|                   |   |
|-------------------|---|
| <b>Upholstery</b> |   |
| <b>TA</b>         | FAUX LEATHER <b>Secret</b> , FABRIC <b>Mirage</b> , FABRIC <b>Cotton Club</b> , FABRIC <b>Renewed Loop</b>  |
| <b>TC</b>         | VELVET SUPERB, FABRIC <b>Second</b> , FABRIC <b>Main Line Flax</b> , FABRIC <b>Oceanic</b> , FABRIC <b>Jumper</b> , FABRIC <b>Flame</b> , FABRIC <b>Ouche</b> , FABRIC <b>Plain</b> , FABRIC <b>Gemma</b> , FABRIC <b>Caltagirone 114</b> |
| <b>TE</b>         | FABRIC <b>Uniform Melange</b>   |
| <b>SV</b>         | LEATHER <b>Vintage</b>  |
| <b>TB</b>         | FAUX LEATHER <b>Vintage</b> , FABRIC <b>Fenix Wool</b> , FABRIC <b>Visual</b> , FABRIC <b>Manhattan</b> , FABRIC <b>Novabuk</b> , FABRIC <b>Network</b> , FABRIC <b>Gyre</b>  |
| <b>TD</b>         | FABRIC <b>Yoredale</b> , FABRIC <b>Remix 3</b>  |
| <b>SF</b>         | LEATHER <b>Fiore</b>  |

**COM/COL - Minimum Q.ty 6 pc. for each material. For weft or patterned fabrics see specific pages**

|  |  |   |  |
|--|--|---|--|
|  | S SG PP_TS Mtl. 0.60 h. 1.40 Each - S SG TS Mtl. 0.92 h. 1.40 Each |  | S SG PP_TS Mq. 0.70 Each - S SG TS Mq. 1.90 Each |
|--|--|---|--|

**COM/COL - Minimum Q.ty 6 pc. for each material. For weft or patterned fabrics see specific pages**

|  |  |   |  |
|--|--|---|--|
|  | P SG PP_TS Mtl. 0.60 h. 1.40 Each - P SG TS Mtl. 1.10 h. 1.40 Each |  | P SG PP_TS Mq. 0.70 Each - P SG TS Mq. 2.40 Each |
|--|--|---|--|

**Optionals:**

|              | Value  | Options/notes  |
|--------------|--------|--|
| <b>FM-M2</b> | + 48 € | ASH GREY <b>ES</b> , BLUE SAPPHIRE <b>EE</b> , BLUE TURQUOISE <b>EH</b> , BRONZE <b>E2</b> , BULGARO RED <b>FP</b> , CHERRY RED <b>EQ</b> , DARK GREEN <b>EL</b> , FACEPOWDER PINK <b>E8</b> , FANGO <b>E3</b> , GOLDEN YELLOW <b>EO</b> , LIGHT BLUE <b>EO</b> , LIGHT GREY <b>ET</b> , OCEAN BLUE <b>EI</b> , OCHER YELLOW <b>E7</b> , PAPAYA ORANGE <b>EA</b> , PASTEL YELLOW <b>E4</b> , PINE GREEN <b>EJ</b> , RED <b>ER</b> , SAGE GREEN <b>E9</b> |
| <b>ES-1</b>  | + 6 €  | ES-1   |

**Calla S SG PP**

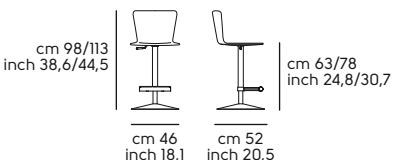

**Calla P SG PP**

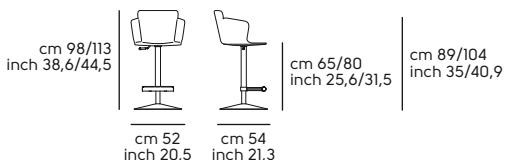

**Calla S SG PP\_TS**

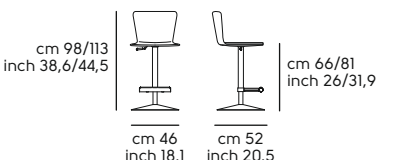

**Calla P SG PP\_TS**

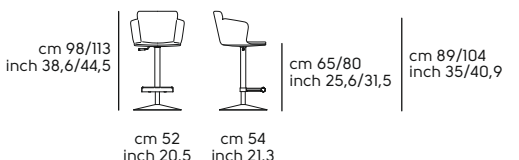

**Calla S SG TS**

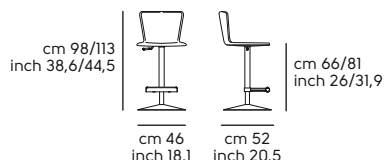



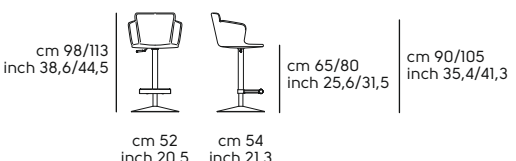

**Calla P SG TS**



# Cover design Officina delle Idee

## Cover S - Shell in fabric or leather

Frame in: metal or wood

| Model  | Code      | Base type | Frame | Shell |       |       |       |       |       |       |       |       | Optional                        | G.ty   | boxes  | Kg         | M <sup>3</sup> |
|--|-----------|-----------|-------|-------|-------|-------|-------|-------|-------|-------|-------|-------|---------------------------------|--------|--------|------------|----------------|
|  |           |           |       | TA    | TB    | TC    | TD    | TE    | SF    | SV    | COM   | COL   |                                 |        |        |            |                |
| <b>Chair COVER S M_M TS</b><br>  | S1071MT_M | _M        | M1    | 236 € | 249 € | 287 € | 315 € | 430 € | 337 € | 401 € | 236 € | 287 € | FM-M2<br>FM-M3<br>ES-1<br>PD-F0 | 2<br>4 | 1<br>1 | 16<br>30.0 | 0.35<br>0.45   |
| <b>Chair COVER S M_T TS</b><br>   | S1071MT_T | _T        | M1    | 257 € | 270 € | 308 € | 336 € | 451 € | 358 € | 422 € | 257 € | 308 € | FM-M2<br>FM-M3<br>ES-1          | 2      | 1      | 16         | 0.38           |
| <b>Chair COVER S M_Q TS</b><br>  | S1071MT_Q | _Q        | M1    | 270 € | 283 € | 321 € | 349 € | 464 € | 371 € | 435 € | 270 € | 321 € | FM-M2<br>ES-1<br>PD-F0          | 2      | 1      | 16         | 0.26           |
| <b>Chair COVER S L_R TS</b><br>   | S1071WO_R | _R        | LF1   | 330 € | 344 € | 380 € | 408 € | 523 € | 430 € | 495 € | 330 € | 380 € | ES-1<br>PD-F0                   | 2      | 1      | 14.5       | 0.46           |

**Frame finishes**

| Metal     |   | Wood       |  |
|-----------|---|------------|--|
| <b>MI</b> | WHITE <b>BB</b> , BROWN <b>E6</b> , SAND <b>EC</b> , WHITE PEARL <b>EF</b> , GRAPHITE <b>EG</b> , BLACK <b>EN</b> | <b>LFI</b> | Ash wood stained BLACK <b>F04</b> , Ash wood stained WHITE <b>F05</b> , Ash wood stained CHERRY RED <b>F09</b> , Ash wood stained FLAMED WALNUT <b>F24</b> , Ash wood stained DARK BROWN <b>F26</b> , Ash wood stained NATURAL <b>F40</b> , Ash wood stained NATURAL OAK <b>F52</b> , Ash wood stained WHITENED <b>F60</b> , Ash wood stained DESERT <b>F61</b> , Ash wood stained LIGHT GREY <b>F62</b> , Ash wood stained DARK GREY <b>F63</b> |

**Shell finishes**

| Upholstery |   |
|------------|---|
| <b>TA</b>  | FAUX LEATHER <b>Secret</b> , FABRIC <b>Mirage</b> , FABRIC <b>Cotton Club</b> , FABRIC <b>Renewed Loop</b>  |
| <b>TC</b>  | VELVET SUPERB, FABRIC <b>Second</b> , FABRIC <b>Main Line Flax</b> , FABRIC <b>Oceanic</b> , FABRIC <b>Jumper</b> , FABRIC <b>Flame</b> , FABRIC <b>Ouche</b> , FABRIC <b>Plain</b> , FABRIC <b>Gemma</b> , FABRIC <b>Caltagirone 114</b> |
| <b>TE</b>  | FABRIC <b>Uniform Melange</b>   |
| <b>SV</b>  | LEATHER <b>Vintage</b>  |
| <b>TB</b>  | FAUX LEATHER <b>Vintage</b> , FABRIC <b>Fenix Wool</b> , FABRIC <b>Visual</b> , FABRIC <b>Manhattan</b> , FABRIC <b>Novabuk</b> , FABRIC <b>Network</b> , FABRIC <b>Gyre</b>  |
| <b>TD</b>  | FABRIC <b>Yoredale</b> , FABRIC <b>Remix 3</b>  |
| <b>SF</b>  | LEATHER <b>Fiore</b>  |

**COM/COL - Minimum Q.ty 6 pc. for each material. For weft or patterned fabrics see specific pages**

|  |                        |   |               |
|--|------------------------|---|---------------|
| <b>COM</b><br> | Mtl. 0.80 h. 1.40 Each | <b>COL</b><br> | Mq. 1.43 Each |
|--|------------------------|---|---------------|

**Optionals:**

|              | Value  | Options/notes  |
|--------------|--------|--|
| <b>FM-M2</b> | + 48 € | ASH GREY <b>ES</b> , BLUE SAPPHIRE <b>EE</b> , BLUE TURQUOISE <b>EH</b> , BRONZE <b>E2</b> , BULGARO RED <b>FP</b> , CHERRY RED <b>EQ</b> , DARK GREEN <b>EL</b> , FACEPOWDER PINK <b>E8</b> , FANGO <b>E3</b> , GOLDEN YELLOW <b>EO</b> , LIGHT BLUE <b>EO</b> , LIGHT GREY <b>ET</b> , OCEAN BLUE <b>EI</b> , OCHER YELLOW <b>E7</b> , PAPAYA ORANGE <b>EA</b> , PASTEL YELLOW <b>E4</b> , PINE GREEN <b>EJ</b> , RED <b>ER</b> , SAGE GREEN <b>E9</b> |
| <b>FM-M3</b> | + 21 € | CHROME <b>CC</b>   |
| <b>ES-1</b>  | + 6 €  | ES-1   |
| <b>PD-F0</b> | + 6 €  | PD-F0  |

**Cover S\_M**

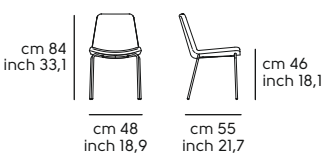

**Cover S\_T**

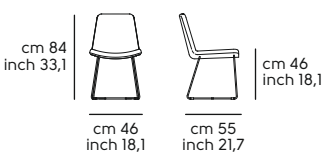

**Cover S\_Q**

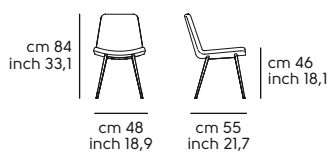

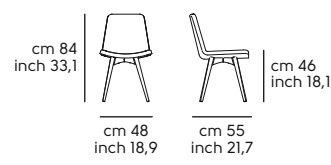

**Cover S\_R**





**Cover P, AT, H65-75-SG - Shell in fabric or leather**

Frame in: metal or wood



| Model  | Code    | Mod. | Frame | Shell |       |       |       |       |       |       |       |       | Optional               | Q.ty | boxes | Kg   | M <sup>2</sup> |
|--|---------|------|-------|-------|-------|-------|-------|-------|-------|-------|-------|-------|------------------------|------|-------|------|----------------|
|  |         |      |       | TA    | TB    | TC    | TD    | TE    | SF    | SV    | COM   | COL   |                        |      |       |      |                |
| <b>Armchair COVER P M TS</b><br>    | S1070PT | P    | M1    | 266 € | 279 € | 317 € | 344 € | 460 € | 367 € | 428 € | 266 € | 317 € | FM-M2<br>FM-M3<br>ES-1 | 2    | 1     | 18.5 | 0.35           |
| <b>Armchair COVER P M TV TS</b><br> | S1070P9 | P-TV | M1    | 315 € | 327 € | 364 € | 393 € | 508 € | 415 € | 479 € | 315 € | 364 € | FM-M2<br>FM-M3<br>ES-1 | 2    | 1     | 18.5 | 0.35           |





**COM/COL - Minimum Q.ty 6 pc. for each material. For weft or patterned fabrics see specific pages**

|  |   |
|--|---|
|  Mtl. 0.80 h. 1.40 Each |  Mq. 1.43 Each |
|--|---|



| Model   | Code    | Mod. | Frame | Shell |       |       |       |       |       |       |       |       | Optional               | Q.ty | boxes | Kg   | M <sup>2</sup> |
|---|---------|------|-------|-------|-------|-------|-------|-------|-------|-------|-------|-------|------------------------|------|-------|------|----------------|
|   |         |      |       | TA    | TB    | TC    | TD    | TE    | SF    | SV    | COM   | COL   |                        |      |       |      |                |
| <b>Waiting Chair COVER AT M TS</b><br> | S1070LT | AT   | M1    | 445 € | 491 € | 525 € | 543 € | 649 € | 558 € | 679 € | 445 € | 525 € | FM-M2<br>FM-M3<br>ES-1 | 1    | 1     | 11.5 | 0.35           |

**COM/COL - Minimum Q.ty 6 pc. for each material. For weft or patterned fabrics see specific pages**

|  |   |
|--|---|
|  Mtl. 1.05 h. 1.40 Each |  Mq. 2.09 Each |
|--|---|

| Model  | Code    | Mod.   | Frame | Shell |       |       |       |       |       |       |       |       | Optional                        | Q.ty | boxes | Kg  | M³           |
|--|---------|--------|-------|-------|-------|-------|-------|-------|-------|-------|-------|-------|---------------------------------|------|-------|-----|--------------|
|  |         |        |       | TA    | TB    | TC    | TD    | TE    | SF    | SV    | COM   | COL   |                                 |      |       |     |              |
| <b>Stool COVER H65 M TS</b><br>  | S1070H0 | H65    | MI    | 250 € | 264 € | 286 € | 294 € | 359 € | 345 € | 373 € | 250 € | 286 € | FM-M2<br>FM-M3<br>ES-1<br>PD-FO | 2    | 1     | 14  | 0.23<br>0.27 |
| <b>Stool COVER H75 M TS</b><br>  | S1070J0 | H75    | MI    | 264 € | 277 € | 297 € | 307 € | 372 € | 359 € | 386 € | 264 € | 297 € | FM-M2<br>FM-M3<br>ES-1<br>PD-FO | 2    | 1     | 15  | 0.25<br>0.32 |
| <b>Stool COVER H65 LR TS</b><br> | S1070HW | H65 LR | LFI   | 310 € | 323 € | 345 € | 355 € | 418 € | 406 € | 434 € | 310 € | 345 € | ES-1<br>PD-FO                   | 1    | 1     | 6.7 | 0.18         |
| <b>Stool COVER H75 LR TS</b><br> | S1070JW | H75 LR | LFI   | 314 € | 326 € | 347 € | 357 € | 422 € | 408 € | 436 € | 314 € | 347 € | ES-1<br>PD-FO                   | 1    | 1     | 7   | 0.22         |
| <b>Stool COVER SG TS</b><br>   | S1070ZT | SG     | MI    | 521 € | 535 € | 555 € | 565 € | 629 € | 617 € | 644 € | 521 € | 555 € | FM-M2<br>ES-1                   | 1    | 1     | 17  | 0.20         |

**COM/COL - Minimum Q.ty 6 pc. for each material. For weft or patterned fabrics see specific pages**

|  |                        |   |               |
|--|------------------------|---|---------------|
|  | Mtl. 0.45 h. 1.40 Each |  | Mq. 1.01 Each |
|--|------------------------|---|---------------|

**Frame finishes**

**Metal**

|           |   |
|-----------|---|
| <b>MI</b> | WHITE <b>BB</b> , BROWN <b>E6</b> , SAND <b>EC</b> , WHITE PEARL <b>EF</b> , GRAPHITE <b>EG</b> , BLACK <b>EN</b> |
|-----------|---|

**Wood**

|            |  |
|------------|--|
| <b>LFI</b> | Ash wood stained BLACK <b>F04</b> , Ash wood stained WHITE <b>F05</b> , Ash wood stained CHERRY RED <b>F09</b> , Ash wood stained FLAMED WALNUT <b>F24</b> , Ash wood stained DARK BROWN <b>F26</b> , Ash wood stained NATURAL <b>F40</b> , Ash wood stained NATURAL OAK <b>F52</b> , Ash wood stained WHITENED <b>F60</b> , Ash wood stained DESERT <b>F61</b> , Ash wood stained LIGHT GREY <b>F62</b> , Ash wood stained DARK GREY <b>F63</b> |
|------------|--|

**Shell finishes**

**Upholstery**

|           |   |           |  |
|-----------|---|-----------|--|
| <b>TA</b> | FAUX LEATHER <b>Secret</b> , FABRIC <b>Mirage</b> , FABRIC <b>Cotton Club</b> , FABRIC <b>Renewed Loop</b>  | <b>TB</b> | FAUX LEATHER <b>Vintage</b> , FABRIC <b>Fenix Wool</b> , FABRIC <b>Visual</b> , FABRIC <b>Manhattan</b> , FABRIC <b>Novabuk</b> , FABRIC <b>Network</b> , FABRIC <b>Gyre</b> |
| <b>TC</b> | VELVET SUPERB, FABRIC <b>Second</b> , FABRIC <b>Main Line Flax</b> , FABRIC <b>Oceanic</b> , FABRIC <b>Jumper</b> , FABRIC <b>Flame</b> , FABRIC <b>Ouche</b> , FABRIC <b>Plain</b> , FABRIC <b>Gemma</b> , FABRIC <b>Caltagirone 114</b> | <b>TD</b> | FABRIC <b>Yoredale</b> , FABRIC <b>Remix 3</b>   |
| <b>TE</b> | FABRIC <b>Uniform Melange</b>   | <b>SF</b> | LEATHER <b>Fiore</b>   |
| <b>SV</b> | LEATHER <b>Vintage</b>  |           |  |

**Optionals:**

|              | Value  | Options/notes  |
|--------------|--------|--|
| <b>FM-M2</b> | + 48 € | INDOOR MATT METAL M2<br>ASH GREY <b>ES</b> , BLUE SAPPHIRE <b>EE</b> , BLUE TURQUOISE <b>EH</b> , BRONZE <b>E2</b> , BULGARO RED <b>FP</b> , CHERRY RED <b>EQ</b> , DARK GREEN <b>EL</b> , FACEPOWDER PINK <b>E8</b> , FANGO <b>E3</b> , GOLDEN YELLOW <b>EO</b> , LIGHT BLUE <b>EO</b> , LIGHT GREY <b>ET</b> , OCEAN BLUE <b>EI</b> , OCHER YELLOW <b>E7</b> , PAPAYA ORANGE <b>EA</b> , PASTEL YELLOW <b>E4</b> , PINE GREEN <b>EJ</b> , RED <b>ER</b> , SAGE GREEN <b>E9</b> |
| <b>FM-M3</b> | + 21 € | INDOOR GLOSSY METAL M3<br>CHROME <b>CC</b>   |
| <b>ES-1</b>  | + 6 €  | FIREPROOF FOAM<br>ES-1   |
| <b>PD-F0</b> | + 6 €  | FELT PAD FEET<br>PD-F0   |

**Cover P**

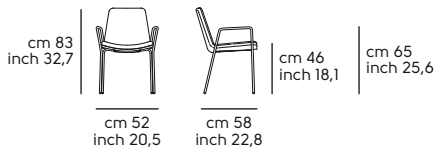

**Cover P-TV**

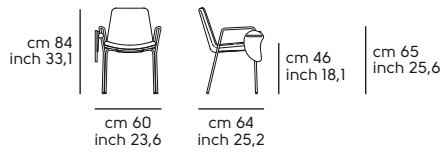

**Cover AT**

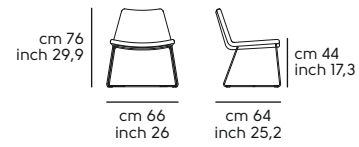

**Cover H65**

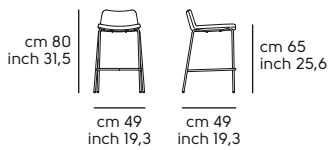

**Cover H75**

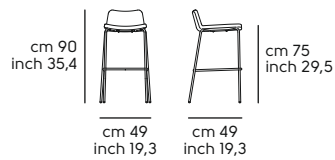

**Cover H65 LR**

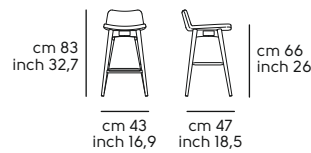

**Cover H75 LR**

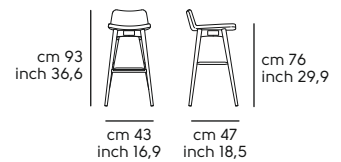



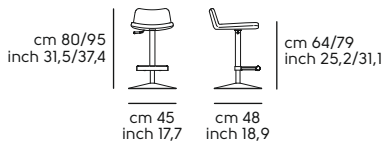





**Cover SG**



# Dalia design Beatriz Sempere

## Dalia S, DS - Shell in fabric or leather

Frame in: metal or wood

| Model  | Code      | Base type | Frame | Shell |       |       |       |       |       |       |       |       | Optional                        | G.ty | boxes | Kg   | M <sup>3</sup> |
|--|-----------|-----------|-------|-------|-------|-------|-------|-------|-------|-------|-------|-------|---------------------------------|------|-------|------|----------------|
|  |           |           |       | TA    | TB    | TC    | TD    | TE    | SF    | SV    | COM   | COL   |                                 |      |       |      |                |
| <b>Chair DALIA S M_M TS</b><br>                    | S185ISM_M | _M        | MI    | 300 € | 345 € | 393 € | 406 € | 499 € | 486 € | 593 € | 300 € | 393 € | FM-M2<br>FM-M3<br>ES-1<br>PD-FO | 2    | 1     | 18.5 | 0.51           |
| <b>Chair DALIA S M_T TS</b><br>                    | S185ISM_T | _T        | MI    | 326 € | 371 € | 419 € | 432 € | 525 € | 512 € | 619 € | 326 € | 419 € | FM-M2<br>FM-M3                  | 2    | 1     | 19.2 | 0.44           |
| <b>Chair DALIA S M_Q TS</b><br>                   | S185ISM_Q | _Q        | MI    | 349 € | 394 € | 442 € | 455 € | 548 € | 535 € | 642 € | 349 € | 442 € | FM-M2<br>PD-FO                  | 2    | 1     | 19.3 | 0.47           |
| <b>Chair DALIA S L_R TS</b><br>                  | S185ISL_R | _R        | LFI   | 392 € | 441 € | 490 € | 501 € | 594 € | 580 € | 687 € | 392 € | 490 € | FL-I2<br>ES-1<br>PD-FO          | 2    | 1     | 18   | 0.47           |
| <b>Chair DALIA S L_N TS</b><br>                  | S185ISL_N | _N        | LII   | 496 € | 545 € | 594 € | 605 € | 698 € | 684 € | 791 € | 496 € | 594 € | FL-I2<br>PD-FO                  | 2    | 1     | 18   | 0.47           |
| <b>Chair DALIA S X47 TS</b><br>                  | S185ISX   | X47       | MI    | 496 € | 545 € | 593 € | 604 € | 698 € | 684 € | 791 € | 500 € | 593 € | FM-M2                           | 1    | 1     | 11.4 | 0.32           |
| <b>Chair with self-return DALIA S X47 TS</b><br> | S185ISY   | X47       | MI    | 529 € | 579 € | 627 € | 640 € | 733 € | 719 € | 826 € | 529 € | 627 € | FM-M2                           | 1    | 1     | 11.4 | 0.32           |
| <b>Office Chair DALIA DS TS</b><br>              | S1850DS   | DS        | MI    | 541 € | 588 € | 639 € | 649 € | 742 € | 730 € | 835 € | 541 € | 639 € | FM-M2<br>ES-1                   | 1    | 2     | 13.7 | 0.29           |
| <b>Office Chair DALIA DS 47 TS</b><br>           | S1850DS   | DS 47     | MI    | 541 € | 588 € | 639 € | 649 € | 742 € | 730 € | 835 € | 541 € | 639 € | FM-M2                           | 1    | 2     | 13.7 | 0.29           |

**Note:**

TS Front and Back covering available in two-tone or bi-material. Reference price in the upper category

**Frame finishes**

**Metal**

|           |   |
|-----------|---|
| <b>MI</b> | WHITE <b>BB</b> , BROWN <b>E6</b> , SAND <b>EC</b> , WHITE PEARL <b>EF</b> , GRAPHITE <b>EG</b> , BLACK <b>EN</b> |
|-----------|---|

**Wood**



|            |  |
|------------|--|
| <b>LFI</b> | Ash wood stained BLACK <b>F04</b> , Ash wood stained WHITE <b>F05</b> , Ash wood stained CHERRY RED <b>F09</b> , Ash wood stained FLAMED WALNUT <b>F24</b> , Ash wood stained DARK BROWN <b>F26</b> , Ash wood stained NATURAL <b>F40</b> , Ash wood stained NATURAL OAK <b>F52</b> , Ash wood stained WHITENED <b>F60</b> , Ash wood stained DESERT <b>F61</b> , Ash wood stained LIGHT GREY <b>F62</b> , Ash wood stained DARK GREY <b>F63</b>       |
| <b>LII</b> | Veneered wood painted BLACK <b>I04</b> , Veneered wood painted WHITE <b>I05</b> , Veneered wood painted CHERRY RED <b>I09</b> , Veneered wood painted DARK BROWN <b>I26</b> , Veneered wood painted NATURAL <b>I40</b> , Veneered wood painted NATURAL OAK <b>I52</b> , Veneered wood painted WHITENED <b>I60</b> , Veneered wood painted DESERT <b>I61</b> , Veneered wood painted LIGHT GREY <b>I62</b> , Veneered wood painted DARK GREY <b>I63</b> |

**Shell finishes**

**Upholstery**

|           |   |           |  |
|-----------|---|-----------|--|
| <b>TA</b> | FAUX LEATHER <b>Secret</b> , FABRIC <b>Mirage</b> , FABRIC <b>Cotton Club</b> , FABRIC <b>Renewed Loop</b>  | <b>TB</b> | FAUX LEATHER <b>Vintage</b> , FABRIC <b>Fenix Wool</b> , FABRIC <b>Visual</b> , FABRIC <b>Manhattan</b> , FABRIC <b>Novabuk</b> , FABRIC <b>Network</b> , FABRIC <b>Gyre</b> |
| <b>TC</b> | VELVET SUPERB, FABRIC <b>Second</b> , FABRIC <b>Main Line Flax</b> , FABRIC <b>Oceanic</b> , FABRIC <b>Jumper</b> , FABRIC <b>Flame</b> , FABRIC <b>Ouche</b> , FABRIC <b>Plain</b> , FABRIC <b>Gemma</b> , FABRIC <b>Caltagirone I14</b> | <b>TD</b> | FABRIC <b>Yoredale</b> , FABRIC <b>Remix 3</b>   |
| <b>TE</b> | FABRIC <b>Uniform Melange</b>   | <b>SF</b> | LEATHER <b>Fiore</b>   |
| <b>SV</b> | LEATHER <b>Vintage</b>  |           |  |

**COM/COL - Minimum Q.ty 6 pc. for each material. For weft or patterned fabrics see specific pages**

|  |                        |  |               |
|--|------------------------|--|---------------|
| <b>COM</b><br> | Mtl. 0.80 h. 1.40 Each | <b>COL</b><br> | Mq. 1.73 Each |
|--|------------------------|--|---------------|

**Optionals:**

|              |                          | Value  | Options/notes  |
|--------------|--------------------------|--------|--|
| <b>FM-M2</b> | Indoor matt metal M2     | + 48 € | ASH GREY <b>ES</b> , BLUE SAPPHIRE <b>EE</b> , BLUE TURQUOISE <b>EH</b> , BRONZE <b>E2</b> , BULGARO RED <b>FP</b> , CHERRY RED <b>EQ</b> , DARK GREEN <b>EL</b> , FACEPOWDER PINK <b>E8</b> , FANGO <b>E3</b> , GOLDEN YELLOW <b>EO</b> , LIGHT BLUE <b>EO</b> , LIGHT GREY <b>ET</b> , OCEAN BLUE <b>EI</b> , OCHER YELLOW <b>E7</b> , PAPAYA ORANGE <b>EA</b> , PASTEL YELLOW <b>E4</b> , PINE GREEN <b>EJ</b> , RED <b>ER</b> , SAGE GREEN <b>E9</b> |
| <b>FM-M3</b> | Indoor glossy metal M3   | + 21 € | CHROME <b>CC</b>   |
| <b>FL-I2</b> | Veneered wood finish LI2 | + 8 €  | Veneered wood FLAMED WALNUT <b>I24</b> , Veneered wood NATURAL OAK <b>I22</b>  |
| <b>PD-F0</b> | Felt pad feet            | + 6 €  | PD-F0  |

**Dalia S\_M**

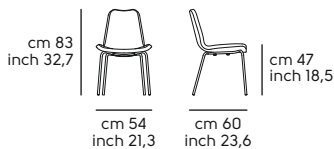

**Dalia S\_T**

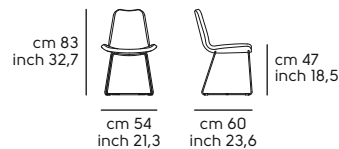

**Dalia S\_Q**



**Dalia S\_R**

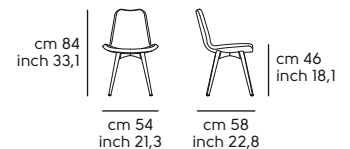

**Dalia S\_N**

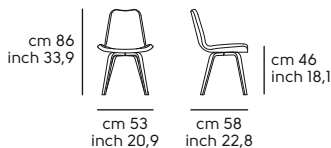

**Dalia S\_X47**





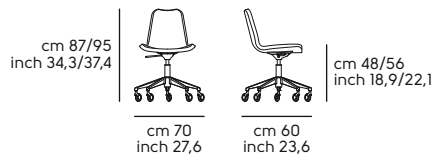





**Dalia S\_DS**



**Dalia PB, DPB - Shell in fabric or leather**

Frame in: metal or wood

| Model  | Code      | Base type | Frame | Shell |       |       |       |       |       |       |       |       | Optional                        | Q.ty | boxes | Kg   | M³   |
|--|-----------|-----------|-------|-------|-------|-------|-------|-------|-------|-------|-------|-------|---------------------------------|------|-------|------|------|
|  |           |           |       | TA    | TB    | TC    | TD    | TE    | SF    | SV    | COM   | COL   |                                 |      |       |      |      |
| <b>Armchair DALIA PB M_M TS</b><br>                  | S1851PB_M | _M        | MI    | 386 € | 433 € | 493 € | 498 € | 631 € | 614 € | 737 € | 386 € | 493 € | FM-M2<br>FM-M3<br>ES-1<br>PD-FO | 1    | 1     | 11.1 | 0.35 |
| <b>Armchair DALIA PB M_T TS</b><br>                  | S1851PB_T | _T        | MI    | 410 € | 457 € | 517 € | 522 € | 655 € | 638 € | 761 € | 410 € | 517 € | FM-M2<br>FM-M3                  | 1    | 1     | 11.4 | 0.35 |
| <b>Armchair DALIA PB M_Q TS</b><br>                  | S1851PB_Q | _Q        | MI    | 433 € | 480 € | 540 € | 545 € | 678 € | 661 € | 784 € | 433 € | 540 € | FM-M2<br>PD-FO                  | 1    | 1     | 11.5 | 0.34 |
| <b>Armchair DALIA PB L_R TS</b><br>                 | S1851LB_R | _R        | LFI   | 480 € | 527 € | 588 € | 592 € | 723 € | 708 € | 832 € | 480 € | 588 € | FL-I2<br>ES-1<br>PD-FO          | 1    | 1     | 10.8 | 0.35 |
| <b>Armchair DALIA PB L_N TS</b><br>                | S1851LB_N | _N        | LII   | 583 € | 630 € | 691 € | 695 € | 826 € | 811 € | 935 € | 583 € | 691 € | FL-I2<br>PD-FO                  | 1    | 1     | 10.8 | 0.35 |
| <b>Armchair DALIA PB X47 TS</b><br>                | S1851BX   | X47       | MI    | 582 € | 629 € | 692 € | 700 € | 831 € | 805 € | 936 € | 582 € | 692 € | FM-M2                           | 1    | 1     | 11.7 | 0.31 |
| <b>Armch. with self-return DALIA PB X47 TS</b><br> | S1851BY   | X47       | MI    | 616 € | 665 € | 725 € | 735 € | 865 € | 838 € | 970 € | 616 € | 725 € | FM-M2                           | 1    | 1     | 11.7 | 0.31 |
| <b>Office Arm. DALIA DPB TS</b><br>                | S1850EB   | DPB       | MI    | 627 € | 676 € | 737 € | 718 € | 875 € | 816 € | 980 € | 627 € | 737 € | FM-M2<br>ES-1                   | 1    | 2     | 15   | 0.30 |
| <b>Office Arm. DALIA DPB 47 TS</b><br>             | S1850EB   | DPB 47    | MI    | 627 € | 676 € | 737 € | 747 € | 875 € | 849 € | 980 € | 627 € | 737 € | FM-M2                           | 1    | 2     | 15   | 0.30 |

**Note:**  
TS Front and Back covering available in two-tone or bi-material. Reference price in the upper category

**Frame finishes**

**Metal**

|           |   |
|-----------|---|
| <b>MI</b> | WHITE <b>BB</b> , BROWN <b>E6</b> , SAND <b>EC</b> , WHITE PEARL <b>EF</b> , GRAPHITE <b>EG</b> , BLACK <b>EN</b> |
|-----------|---|

**Wood**

|            |  |
|------------|--|
| <b>LFI</b> | Ash wood stained BLACK <b>F04</b> , Ash wood stained WHITE <b>F05</b> , Ash wood stained CHERRY RED <b>F09</b> , Ash wood stained FLAMED WALNUT <b>F24</b> , Ash wood stained DARK BROWN <b>F26</b> , Ash wood stained NATURAL <b>F40</b> , Ash wood stained NATURAL OAK <b>F52</b> , Ash wood stained WHITENED <b>F60</b> , Ash wood stained DESERT <b>F61</b> , Ash wood stained LIGHT GREY <b>F62</b> , Ash wood stained DARK GREY <b>F63</b>       |
| <b>LII</b> | Veneered wood painted BLACK <b>I04</b> , Veneered wood painted WHITE <b>I05</b> , Veneered wood painted CHERRY RED <b>I09</b> , Veneered wood painted DARK BROWN <b>I26</b> , Veneered wood painted NATURAL <b>I40</b> , Veneered wood painted NATURAL OAK <b>I52</b> , Veneered wood painted WHITENED <b>I60</b> , Veneered wood painted DESERT <b>I61</b> , Veneered wood painted LIGHT GREY <b>I62</b> , Veneered wood painted DARK GREY <b>I63</b> |

**Shell finishes**

**Upholstery**

|           |   |           |  |
|-----------|---|-----------|--|
| <b>TA</b> | FAUX LEATHER <b>Secret</b> , FABRIC <b>Mirage</b> , FABRIC <b>Cotton Club</b> , FABRIC <b>Renewed Loop</b>  | <b>TB</b> | FAUX LEATHER <b>Vintage</b> , FABRIC <b>Fenix Wool</b> , FABRIC <b>Visual</b> , FABRIC <b>Manhattan</b> , FABRIC <b>Novabuk</b> , FABRIC <b>Network</b> , FABRIC <b>Gyre</b> |
| <b>TC</b> | VELVET SUPERB, FABRIC <b>Second</b> , FABRIC <b>Main Line Flax</b> , FABRIC <b>Oceanic</b> , FABRIC <b>Jumper</b> , FABRIC <b>Flame</b> , FABRIC <b>Ouche</b> , FABRIC <b>Plain</b> , FABRIC <b>Gemma</b> , FABRIC <b>Caltagirone I14</b> | <b>TD</b> | FABRIC <b>Yoredale</b> , FABRIC <b>Remix 3</b>   |
| <b>TE</b> | FABRIC <b>Uniform Melange</b>   | <b>SF</b> | LEATHER <b>Fiore</b>   |
| <b>SV</b> | LEATHER <b>Vintage</b>  |           |  |

**COM/COL - Minimum Q.ty 6 pc. for each material. For weft or patterned fabrics see specific pages**

|            |                        |            |               |
|------------|------------------------|------------|---------------|
| <b>COM</b> | Mtl. 1.10 h. 1.40 Each | <b>COL</b> | Mq. 2.35 Each |
|------------|------------------------|------------|---------------|

**Optionals:**

|              |                          | Value  | Options/notes  |
|--------------|--------------------------|--------|--|
| <b>FM-M2</b> | Indoor matt metal M2     | + 48 € | ASH GREY <b>ES</b> , BLUE SAPPHIRE <b>EE</b> , BLUE TURQUOISE <b>EH</b> , BRONZE <b>E2</b> , BULGARO RED <b>FP</b> , CHERRY RED <b>EQ</b> , DARK GREEN <b>EL</b> , FACEPOWDER PINK <b>E8</b> , FANGO <b>E3</b> , GOLDEN YELLOW <b>EO</b> , LIGHT BLUE <b>EO</b> , LIGHT GREY <b>ET</b> , OCEAN BLUE <b>EI</b> , OCHER YELLOW <b>E7</b> , PAPAYA ORANGE <b>EA</b> , PASTEL YELLOW <b>E4</b> , PINE GREEN <b>EJ</b> , RED <b>ER</b> , SAGE GREEN <b>E9</b> |
| <b>FM-M3</b> | Indoor glossy metal M3   | + 21 € | CHROME <b>CC</b>   |
| <b>FL-I2</b> | Veneered wood finish I12 | + 8 €  | Veneered wood FLAMED WALNUT <b>I24</b> , Veneered wood NATURAL OAK <b>I22</b>  |
| <b>PD-F0</b> | Felt pad feet            | + 6 €  | PD-F0  |

**Dalia PB\_M**

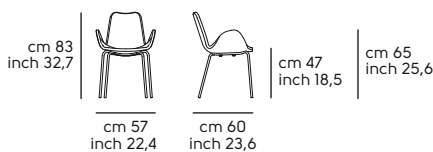

**Dalia PB\_T**

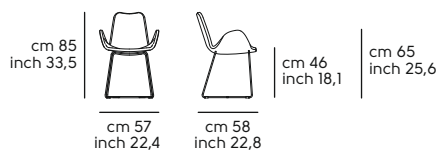

**Dalia PB\_Q**

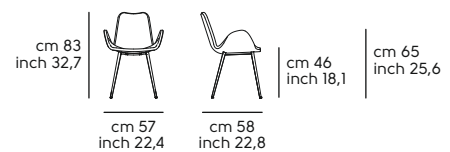

**Dalia PB\_R**

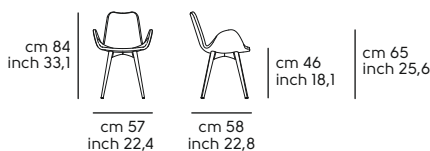

**Dalia PB\_N**

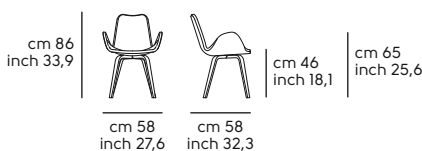

**Dalia PB\_X47**

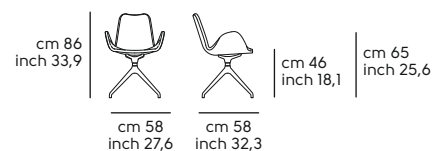



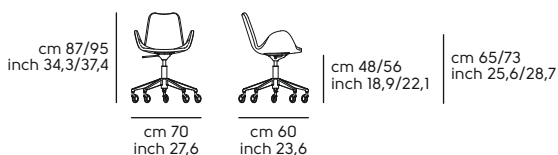









**Dalia PB\_DPB**



### Dalia PA, DPA - Shell in fabric or leather

Frame in: metal or wood

| Model   | Code      | Base type | Frame | Shell |       |       |       |       |       |         |       |       | Optional                        | Q.ty | boxes | Kg    | M³   |
|---|-----------|-----------|-------|-------|-------|-------|-------|-------|-------|---------|-------|-------|---------------------------------|------|-------|-------|------|
|   |           |           |       | TA    | TB    | TC    | TD    | TE    | SF    | SV      | COM   | COL   |                                 |      |       |       |      |
| <b>Armchair DALIA PA M_M TS</b><br>   | S1851PA_M | _M        | MI    | 422 € | 484 € | 538 € | 554 € | 690 € | 668 € | 792 €   | 422 € | 538 € | FM-M2<br>FM-M3<br>ES-1<br>PD-FO | 1    | 1     | 11.4  | 0.48 |
| <b>Armchair DALIA PA M_T TS</b><br>   | S1851PA_T | _T        | MI    | 447 € | 509 € | 563 € | 579 € | 715 € | 693 € | 817 €   | 447 € | 563 € | FM-M2<br>FM-M3                  | 1    | 1     | 11.8  | 0.41 |
| <b>Armchair DALIA PA M_Q TS</b><br>   | S1851PA_Q | _Q        | MI    | 468 € | 530 € | 584 € | 600 € | 736 € | 714 € | 838 €   | 468 € | 584 € | FM-M2<br>PD-FO                  | 1    | 1     | 11.8  | 0.41 |
| <b>Armchair DALIA PA L_R TS</b><br>  | S1851LA_R | _R        | LFI   | 515 € | 576 € | 630 € | 647 € | 785 € | 761 € | 886 €   | 515 € | 630 € | FL-I2<br>ES-1<br>PD-FO          | 1    | 1     | 11.2  | 0.41 |
| <b>Armchair DALIA PA L_N TS</b><br>   | S1851LA_N | _N        | LII   | 619 € | 680 € | 734 € | 751 € | 889 € | 865 € | 990 €   | 619 € | 734 € | FL-I2<br>PD-FO                  | 1    | 1     | 11.2  | 0.41 |
| <b>Armchair DALIA PA X47 TS</b><br><br>                | S1851AX   | X47       | MI    | 620 € | 683 € | 737 € | 759 € | 892 € | 867 € | 992 €   | 620 € | 737 € | FM-M2                           | 1    | 1     | 12.25 | 0.40 |
| <b>Armch. with self-return DALIA PA X47 TS</b><br><br> | S1851AY   | X47       | MI    | 654 € | 717 € | 771 € | 792 € | 920 € | 901 € | 1.025 € | 654 € | 771 € | FM-M2                           | 1    | 1     | 12.25 | 0.40 |
| <b>Office Arm. DALIA DPA TS</b><br><br>                | S1850EA   | DPA       | MI    | 664 € | 727 € | 780 € | 772 € | 932 € | 911 € | 1.036 € | 664 € | 780 € | FM-M2<br>ES-1                   | 1    | 2     | 15.8  | 0.36 |
| <b>Office Arm. DALIA DPA 47 TS</b><br><br>             | S1850EA   | DPA 47    | MI    | 664 € | 727 € | 780 € | 803 € | 932 € | 911 € | 1.036 € | 664 € | 780 € | FM-M2                           | 1    | 2     | 15.8  | 0.36 |

**Note:**  
TS Front and Back covering available in two-tone or bi-material. Reference price in the upper category

**Frame finishes**

**Metal**

|           |   |
|-----------|---|
| <b>MI</b> | WHITE <b>BB</b> , BROWN <b>E6</b> , SAND <b>EC</b> , WHITE PEARL <b>EF</b> , GRAPHITE <b>EG</b> , BLACK <b>EN</b> |
|-----------|---|

**Wood**



|            |  |
|------------|--|
| <b>LFI</b> | Ash wood stained BLACK <b>F04</b> , Ash wood stained WHITE <b>F05</b> , Ash wood stained CHERRY RED <b>F09</b> , Ash wood stained FLAMED WALNUT <b>F24</b> , Ash wood stained DARK BROWN <b>F26</b> , Ash wood stained NATURAL <b>F40</b> , Ash wood stained NATURAL OAK <b>F52</b> , Ash wood stained WHITENED <b>F60</b> , Ash wood stained DESERT <b>F61</b> , Ash wood stained LIGHT GREY <b>F62</b> , Ash wood stained DARK GREY <b>F63</b> |
| <b>LII</b> | Veneered wood painted BLACK <b>I04</b> , Veneered wood painted WHITE <b>I05</b> , Veneered wood painted CHERRY RED <b>I09</b> , Veneered wood painted DARK BROWN <b>I26</b> , Veneered wood painted NATURAL <b>I40</b> , Veneered wood painted NATURAL OAK <b>I52</b>  |

**Shell finishes**

**Upholstery**

|           |   |           |  |
|-----------|---|-----------|--|
| <b>TA</b> | FAUX LEATHER <b>Secret</b> , FABRIC <b>Mirage</b> , FABRIC <b>Cotton Club</b> , FABRIC <b>Renewed Loop</b>  | <b>TB</b> | FAUX LEATHER <b>Vintage</b> , FABRIC <b>Fenix Wool</b> , FABRIC <b>Visual</b> , FABRIC <b>Manhattan</b> , FABRIC <b>Novabuk</b> , FABRIC <b>Network</b> , FABRIC <b>Gyre</b> |
| <b>TC</b> | VELVET SUPERB, FABRIC <b>Second</b> , FABRIC <b>Main Line Flax</b> , FABRIC <b>Oceanic</b> , FABRIC <b>Jumper</b> , FABRIC <b>Flame</b> , FABRIC <b>Ouche</b> , FABRIC <b>Plain</b> , FABRIC <b>Gemma</b> , FABRIC <b>Caltagirone 114</b> | <b>TD</b> | FABRIC <b>Yoredale</b> , FABRIC <b>Remix 3</b>   |
| <b>TE</b> | FABRIC <b>Uniform Melange</b>   | <b>SF</b> | LEATHER <b>Fiore</b>   |
| <b>SV</b> | LEATHER <b>Vintage</b>  |           |  |

**COM/COL - Minimum Q.ty 6 pc. for each material. For weft or patterned fabrics see specific pages**

|   |                        |   |               |
|---|------------------------|---|---------------|
| <b>COM</b><br> | Mtl. 1.10 h. 1.40 Each | <b>COL</b><br> | Mq. 2.89 Each |
|---|------------------------|---|---------------|

**Optionals:**

|              | Value  | Options/notes  |
|--------------|--------|--|
| <b>FM-M2</b> | + 48 € | ASH GREY <b>ES</b> , BLUE SAPPHIRE <b>EE</b> , BLUE TURQUOISE <b>EH</b> , BRONZE <b>E2</b> , BULGARO RED <b>FP</b> , CHERRY RED <b>EQ</b> , DARK GREEN <b>EL</b> , FACEPOWDER PINK <b>E8</b> , FANGO <b>E3</b> , GOLDEN YELLOW <b>EO</b> , LIGHT BLUE <b>EO</b> , LIGHT GREY <b>ET</b> , OCEAN BLUE <b>EI</b> , OCHER YELLOW <b>E7</b> , PAPAYA ORANGE <b>EA</b> , PASTEL YELLOW <b>E4</b> , PINE GREEN <b>EJ</b> , RED <b>ER</b> , SAGE GREEN <b>E9</b> |
| <b>FM-M3</b> | + 21 € | CHROME <b>CC</b>   |
| <b>FL-I2</b> | + 8 €  | Veneered wood FLAMED WALNUT <b>I24</b> , Veneered wood NATURAL OAK <b>I22</b>  |
| <b>PD-F0</b> | + 6 €  | PD-F0  |

**Dalia PA\_M**

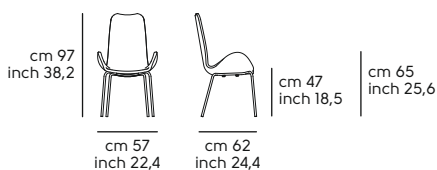

**Dalia PA\_T**

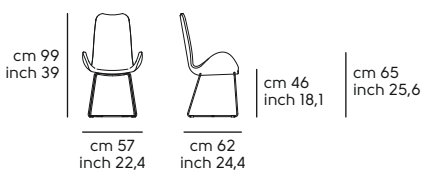

**Dalia PA\_Q**

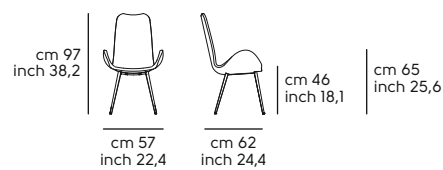

**Dalia PA\_R**

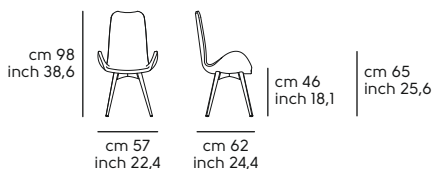

**Dalia PA\_N**

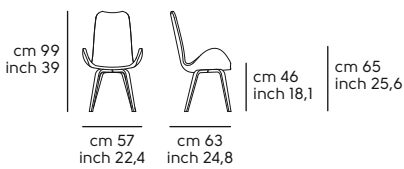

**Dalia PA\_X47**

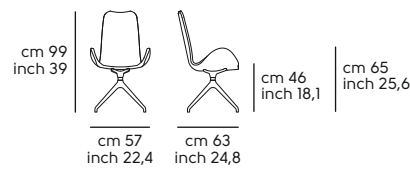

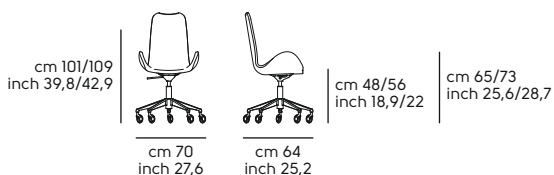

**Dalia PA\_DPA**



## Dalia AP - Shell in fabric or leather

Frame in: metal or wood

| Model  | Code       | Base type | Frame | Shell |       |       |       |         |       |         |       |       | Optional               | G.ty | boxes | Kg   | M³   |
|--|------------|-----------|-------|-------|-------|-------|-------|---------|-------|---------|-------|-------|------------------------|------|-------|------|------|
|  |            |           |       | TA    | TB    | TC    | TD    | TE      | SF    | SV      | COM   | COL   |                        |      |       |      |      |
| <br>Waiting Chair DALIA AP MTS   | S1850APO_T | _T        | MI    | 522 € | 568 € | 628 € | 669 € | 820 €   | 766 € | 905 €   | 522 € | 628 € | FM-M2<br>ES-1<br>PD-FO | 1    | 1     | 14.5 | 0.45 |
| <br>Waiting Chair DALIA AP LN TS | S1850APL   | _N        | LII   | 717 € | 764 € | 826 € | 865 € | 1.016 € | 963 € | 1.102 € | 717 € | 826 € | ES-1<br>PD-FO          | 1    | 1     | 14   | 0.45 |
| <br>Waiting Chair DALIA AP GX TS | S1850APY   | GX        | MI    | 670 € | 717 € | 778 € | 818 € | 969 €   | 916 € | 1.055 € | 670 € | 778 € | FM-M2<br>ES-1          | 1    | 1     | 16   | 0.44 |

**Note:**  
TS Front and Back covering available in two-tone or bi-material. Reference price in the upper category

### Frame finishes

#### Metal

|           |   |
|-----------|---|
| <b>MI</b> | WHITE <b>BB</b> , BROWN <b>E6</b> , SAND <b>EC</b> , WHITE PEARL <b>EF</b> , GRAPHITE <b>EG</b> , BLACK <b>EN</b> |
|-----------|---|

#### Wood

|            |  |
|------------|--|
| <b>LII</b> | Veneered wood painted BLACK <b>I04</b> , Veneered wood painted WHITE <b>I05</b> , Veneered wood painted CHERRY RED <b>I09</b> , Veneered wood painted DARK BROWN <b>I26</b> , Veneered wood painted NATURAL <b>I40</b> , Veneered wood painted NATURAL OAK <b>I52</b> , Veneered wood painted WHITENED <b>I60</b> , Veneered wood painted DESERT <b>I61</b> , Veneered wood painted LIGHT GREY <b>I62</b> , Veneered wood painted DARK GREY <b>I63</b> |
|------------|--|

### Shell finishes

#### Upholstery

|           |   |           |  |
|-----------|---|-----------|--|
| <b>TA</b> | FAUX LEATHER <b>Secret</b> , FABRIC <b>Mirage</b> , FABRIC <b>Cotton Club</b> , FABRIC <b>Renewed Loop</b>  | <b>TB</b> | FAUX LEATHER <b>Vintage</b> , FABRIC <b>Fenix Wool</b> , FABRIC <b>Visual</b> , FABRIC <b>Manhattan</b> , FABRIC <b>Novabuk</b> , FABRIC <b>Network</b> , FABRIC <b>Gyre</b> |
| <b>TC</b> | VELVET SUPERB, FABRIC <b>Second</b> , FABRIC <b>Main Line Flax</b> , FABRIC <b>Oceanic</b> , FABRIC <b>Jumper</b> , FABRIC <b>Flame</b> , FABRIC <b>Ouche</b> , FABRIC <b>Plain</b> , FABRIC <b>Gemma</b> , FABRIC <b>Caltagirone 114</b> | <b>TD</b> | FABRIC <b>Yoredale</b> , FABRIC <b>Remix 3</b>   |
| <b>TE</b> | FABRIC <b>Uniform Melange</b>   | <b>SF</b> | LEATHER <b>Fiore</b>   |
| <b>SV</b> | LEATHER <b>Vintage</b>  |           |  |

**COM/COL - Minimum Q.ty 6 pc. for each material. For weft or patterned fabrics see specific pages**

|            |                        |            |               |
|------------|------------------------|------------|---------------|
| <b>COM</b> | Mtl. 1.85 h. 1.40 Each | <b>COL</b> | Mq. 2.60 Each |
|------------|------------------------|------------|---------------|

### Optionals:

|              | Value  | Options/notes  |
|--------------|--------|--|
| <b>FM-M2</b> | + 52 € | ASH GREY <b>ES</b> , BLUE SAPPHIRE <b>EE</b> , BLUE TURQUOISE <b>EH</b> , BRONZE <b>E2</b> , BULGARO RED <b>FP</b> , CHERRY RED <b>EQ</b> , DARK GREEN <b>EL</b> , FACEPOWDER PINK <b>E8</b> , FANGO <b>E3</b> , GOLDEN YELLOW <b>EO</b> , LIGHT BLUE <b>EO</b> , LIGHT GREY <b>ET</b> , OCEAN BLUE <b>E1</b> , OCHER YELLOW <b>E7</b> , PAPAYA ORANGE <b>EA</b> , PASTEL YELLOW <b>E4</b> , PINE GREEN <b>EJ</b> , RED <b>ER</b> , SAGE GREEN <b>E9</b> |
| <b>ES-1</b>  | + 18 € | ES-1   |
| <b>PD-FO</b> | + 6 €  | PD-FO  |

#### Dalia AP\_T

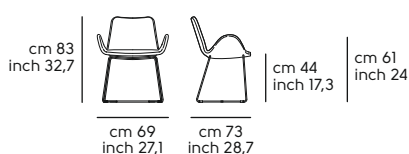

#### Dalia AP\_N

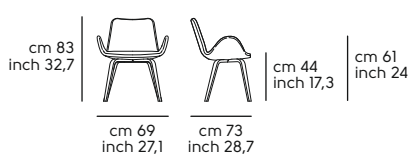

#### Dalia AP\_GX

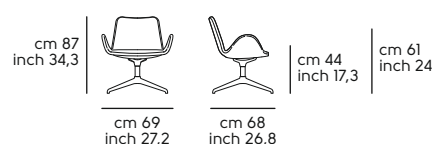

**Dalia DV - Shell in fabric or leather**

Frame in: metal or wood

| Model   | Code       | Base type | Frame | Shell   |         |         |         |         |         |         |         |         | Optional               | Q.ty | boxes | Kg   | M²   |
|---|------------|-----------|-------|---------|---------|---------|---------|---------|---------|---------|---------|---------|------------------------|------|-------|------|------|
|   |            |           |       | TA      | TB      | TC      | TD      | TE      | SF      | SV      | COM     | COL     |                        |      |       |      |      |
| <br><b>Sofa DALIA DV M TS</b>  | S1850D00_T | _T        | MI    | 1.012 € | 1.086 € | 1.190 € | 1.259 € | 1.452 € | 1.276 € | 1.464 € | 1.012 € | 1.190 € | FM-M2<br>ES-1<br>PD-F0 | 1    | 1     | 26   | 0.84 |
| <br><b>Sofa DALIA DV LN TS</b> | S1850D0L_N | _N        | LII   | 1.414 € | 1.490 € | 1.595 € | 1.665 € | 1.856 € | 1.683 € | 1.870 € | 1.414 € | 1.595 € | ES-1<br>PD-F0          | 1    | 1     | 27.8 | 0.84 |

**Note:**

TS Front and Back covering available in two-tone or bi-material. Reference price in the upper category

**Frame finishes**

**Metal**

|           |   |
|-----------|---|
| <b>MI</b> | WHITE <b>BB</b> , BROWN <b>E6</b> , SAND <b>EC</b> , WHITE PEARL <b>EF</b> , GRAPHITE <b>EG</b> , BLACK <b>EN</b> |
|-----------|---|

**Wood**



|            |  |
|------------|--|
| <b>LII</b> | Veneered wood painted BLACK <b>I04</b> , Veneered wood painted WHITE <b>I05</b> , Veneered wood painted CHERRY RED <b>I09</b> , Veneered wood painted DARK BROWN <b>I26</b> , Veneered wood painted NATURAL <b>I40</b> , Veneered wood painted NATURAL OAK <b>I52</b> , Veneered wood painted WHITENED <b>I60</b> , Veneered wood painted DESERT <b>I61</b> , Veneered wood painted LIGHT GREY <b>I62</b> , Veneered wood painted DARK GREY <b>I63</b> |
|------------|--|

**Shell finishes**

**Upholstery**

|           |   |           |  |
|-----------|---|-----------|--|
| <b>TA</b> | FAUX LEATHER <b>Secret</b> , FABRIC <b>Mirage</b> , FABRIC <b>Cotton Club</b> , FABRIC <b>Renewed Loop</b>  | <b>TB</b> | FAUX LEATHER <b>Vintage</b> , FABRIC <b>Fenix Wool</b> , FABRIC <b>Visual</b> , FABRIC <b>Manhattan</b> , FABRIC <b>Novabuk</b> , FABRIC <b>Network</b> , FABRIC <b>Gyre</b> |
| <b>TC</b> | VELVET SUPERB, FABRIC <b>Second</b> , FABRIC <b>Main Line Flax</b> , FABRIC <b>Oceanic</b> , FABRIC <b>Jumper</b> , FABRIC <b>Flame</b> , FABRIC <b>Ouche</b> , FABRIC <b>Plain</b> , FABRIC <b>Gemma</b> , FABRIC <b>Caltagirone II4</b> | <b>TD</b> | FABRIC <b>Yoredale</b> , FABRIC <b>Remix 3</b>   |
| <b>TE</b> | FABRIC <b>Uniform Melange</b>   | <b>SF</b> | LEATHER <b>Fiore</b>   |
| <b>SV</b> | LEATHER <b>Vintage</b>  |           |  |

**COM/COL - Minimum Q.ty 6 pc. for each material. For weft or patterned fabrics see specific pages**

|   |                        |   |               |
|---|------------------------|---|---------------|
| <b>COM</b><br> | Mtl. 2.85 h. 1.40 Each | <b>COL</b><br> | Mq. 3.95 Each |
|---|------------------------|---|---------------|

**Optionals:**

|              | Value  | Options/notes  |
|--------------|--------|--|
| <b>FM-M2</b> | + 52 € | ASH GREY <b>ES</b> , BLUE SAPPHIRE <b>EE</b> , BLUE TURQUOISE <b>EH</b> , BRONZE <b>E2</b> , BULGARO RED <b>FP</b> , CHERRY RED <b>EQ</b> , DARK GREEN <b>EL</b> , FACEPOWDER PINK <b>E8</b> , FANGO <b>E3</b> , GOLDEN YELLOW <b>EO</b> , LIGHT BLUE <b>EO</b> , LIGHT GREY <b>ET</b> , OCEAN BLUE <b>E1</b> , OCHER YELLOW <b>E7</b> , PAPAYA ORANGE <b>EA</b> , PASTEL YELLOW <b>E4</b> , PINE GREEN <b>EJ</b> , RED <b>ER</b> , SAGE GREEN <b>E9</b> |
| <b>ES-1</b>  | + 18 € | ES-1   |
| <b>PD-F0</b> | + 6 €  | PD-F0  |

**Dalia DV\_T**

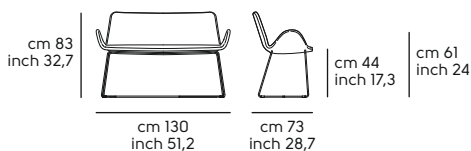

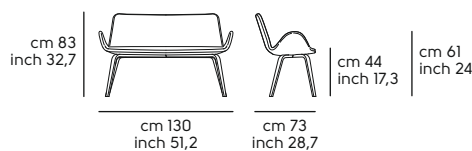

**Dalia DV\_N**



## Dalia PE - Shell in fabric or leather

Frame in: metal or wood

| Model  | Code       | Base type | Frame | Shell |         |         |         |         |         |         |       |         | Optional               | Q.ty | boxes | Kg    | M³   |
|--|------------|-----------|-------|-------|---------|---------|---------|---------|---------|---------|-------|---------|------------------------|------|-------|-------|------|
|  |            |           |       | TA    | TB      | TC      | TD      | TE      | SF      | SV      | COM   | COL     |                        |      |       |       |      |
| <br>Waiting Chair DALIA PE MTS   | S1850PEO_T | _T        | MI    | 788 € | 855 €   | 941 €   | 1.000 € | 1.166 € | 1.037 € | 1.208 € | 788 € | 941 €   | FM-M2<br>ES-1<br>PD-FO | 1    | 1     | 19.35 | 0.74 |
| <br>Waiting Chair DALIA PE LN TS | S1850PEL   | _N        | LII   | 984 € | 1.050 € | 1.138 € | 1.198 € | 1.363 € | 1.233 € | 1.406 € | 984 € | 1.138 € | ES-1<br>PD-FO          | 1    | 1     | 18.75 | 0.74 |
| <br>Waiting Chair DALIA PE GX TS | S1850PEY   | GX        | MI    | 937 € | 1.004 € | 1.090 € | 1.151 € | 1.317 € | 1.187 € | 1.358 € | 937 € | 1.090 € | FM-M2<br>ES-1          | 1    | 1     | 21.1  | 0.7  |

**Note:**  
TS Front and Back covering available in two-tone or bi-material. Reference price in the upper category

### Frame finishes

#### Metal

|           |   |
|-----------|---|
| <b>MI</b> | WHITE <b>BB</b> , BROWN <b>E6</b> , SAND <b>EC</b> , WHITE PEARL <b>EF</b> , GRAPHITE <b>EG</b> , BLACK <b>EN</b> |
|-----------|---|

#### Wood

|            |  |
|------------|--|
| <b>LII</b> | Veneered wood painted BLACK <b>I04</b> , Veneered wood painted WHITE <b>I05</b> , Veneered wood painted CHERRY RED <b>I09</b> , Veneered wood painted DARK BROWN <b>I26</b> , Veneered wood painted NATURAL <b>I40</b> , Veneered wood painted NATURAL OAK <b>I52</b> , Veneered wood painted WHITENED <b>I60</b> , Veneered wood painted DESERT <b>I61</b> , Veneered wood painted LIGHT GREY <b>I62</b> , Veneered wood painted DARK GREY <b>I63</b> |
|------------|--|

### Shell finishes

#### Upholstery

|           |   |           |  |
|-----------|---|-----------|--|
| <b>TA</b> | FAUX LEATHER <b>Secret</b> , FABRIC <b>Mirage</b> , FABRIC <b>Cotton Club</b> , FABRIC <b>Renewed Loop</b>  | <b>TB</b> | FAUX LEATHER <b>Vintage</b> , FABRIC <b>Fenix Wool</b> , FABRIC <b>Visual</b> , FABRIC <b>Manhattan</b> , FABRIC <b>Novabuk</b> , FABRIC <b>Network</b> , FABRIC <b>Gyre</b> |
| <b>TC</b> | VELVET SUPERB, FABRIC <b>Second</b> , FABRIC <b>Main Line Flax</b> , FABRIC <b>Oceanic</b> , FABRIC <b>Jumper</b> , FABRIC <b>Flame</b> , FABRIC <b>Ouche</b> , FABRIC <b>Plain</b> , FABRIC <b>Gemma</b> , FABRIC <b>Caltagirone 114</b> | <b>TD</b> | FABRIC <b>Yoredale</b> , FABRIC <b>Remix 3</b>   |
| <b>TE</b> | FABRIC <b>Uniform Melange</b>   | <b>SF</b> | LEATHER <b>Fiore</b>   |
| <b>SV</b> | LEATHER <b>Vintage</b>  |           |  |

**COM/COL - Minimum Q.ty 6 pc. for each material. For weft or patterned fabrics see specific pages**

|            |                        |            |               |
|------------|------------------------|------------|---------------|
| <b>COM</b> | Mtl. 2.50 h. 1.40 Each | <b>COL</b> | Mq. 3.50 Each |
|------------|------------------------|------------|---------------|

### Optionals:

|              | Value                | Options/notes  |
|--------------|----------------------|--|
| <b>FM-M2</b> | Indoor matt metal M2 | + 52 €<br>ASH GREY <b>ES</b> , BLUE SAPPHIRE <b>EE</b> , BLUE TURQUOISE <b>EH</b> , BRONZE <b>E2</b> , BULGARO RED <b>FP</b> , CHERRY RED <b>EQ</b> , DARK GREEN <b>EL</b> , FACEPOWDER PINK <b>E8</b> , FANGO <b>E3</b> , GOLDEN YELLOW <b>EO</b> , LIGHT BLUE <b>EO</b> , LIGHT GREY <b>ET</b> , OCEAN BLUE <b>E1</b> , OCHER YELLOW <b>E7</b> , PAPAYA ORANGE <b>EA</b> , PASTEL YELLOW <b>E4</b> , PINE GREEN <b>EJ</b> , RED <b>ER</b> , SAGE GREEN <b>E9</b> |
| <b>ES-1</b>  | Fireproof foam       | + 29 €<br>ES-1   |
| <b>PD-FO</b> | Felt pad feet        | + 6 €<br>PD-FO   |

**Dalia PE\_T**

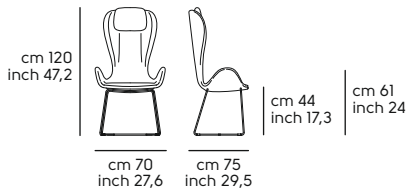

**Dalia PE\_N**

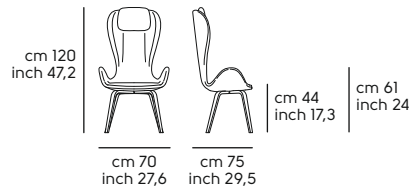

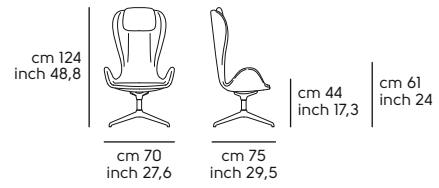

**Dalia PE\_GX**



**Dalia DVE - Shell in fabric or leather**

Frame in: metal or wood

| Model   | Code       | Base type | Frame | Shell   |         |         |         |         |         |         |         | Optional | Q.ty                   | boxes | Kg | M³ |      |
|---|------------|-----------|-------|---------|---------|---------|---------|---------|---------|---------|---------|----------|------------------------|-------|----|----|------|
|   |            |           |       | TA      | TB      | TC      | TD      | TE      | SF      | SV      | COM     |          |                        |       |    |    | COL  |
| <b>Sofa DALIA DVE M TS</b><br>   | S1850DE0_T | _T        | MI    | 1.445 € | 1.560 € | 1.727 € | 1.841 € | 2.146 € | 2.029 € | 2.406 € | 1.445 € | 1.727 €  | FM-M2<br>ES-1<br>PD-F0 | 1     | 1  | 36 | 1.36 |
| <b>Sofa DALIA DVE LN TS</b><br> | S1850DEL   | _N        | LII   | 1.847 € | 1.966 € | 2.132 € | 2.245 € | 2.550 € | 2.434 € | 2.810 € | 1.847 € | 2.132 €  | ES-1<br>PD-F0          | 1     | 1  | 38 | 1.36 |

**Note:**

TS Front and Back covering available in two-tone or bi-material. Reference price in the upper category

**Frame finishes**

**Metal**

|           |   |
|-----------|---|
| <b>MI</b> | WHITE <b>BB</b> , BROWN <b>E6</b> , SAND <b>EC</b> , WHITE PEARL <b>EF</b> , GRAPHITE <b>EG</b> , BLACK <b>EN</b> |
|-----------|---|

**Wood**

|            |  |
|------------|--|
| <b>LII</b> | Veneered wood painted BLACK <b>I04</b> , Veneered wood painted WHITE <b>I05</b> , Veneered wood painted CHERRY RED <b>I09</b> , Veneered wood painted DARK BROWN <b>I26</b> , Veneered wood painted NATURAL <b>I40</b> , Veneered wood painted NATURAL OAK <b>I52</b> , Veneered wood painted WHITENED <b>I60</b> , Veneered wood painted DESERT <b>I61</b> , Veneered wood painted LIGHT GREY <b>I62</b> , Veneered wood painted DARK GREY <b>I63</b> |
|------------|--|

**Shell finishes**

**Upholstery**

|           |   |           |  |
|-----------|---|-----------|--|
| <b>TA</b> | FAUX LEATHER <b>Secret</b> , FABRIC <b>Mirage</b> , FABRIC <b>Cotton Club</b> , FABRIC <b>Renewed Loop</b>  | <b>TB</b> | FAUX LEATHER <b>Vintage</b> , FABRIC <b>Fenix Wool</b> , FABRIC <b>Visual</b> , FABRIC <b>Manhattan</b> , FABRIC <b>Novabuk</b> , FABRIC <b>Network</b> , FABRIC <b>Gyre</b> |
| <b>TC</b> | VELVET SUPERB, FABRIC <b>Second</b> , FABRIC <b>Main Line Flax</b> , FABRIC <b>Oceanic</b> , FABRIC <b>Jumper</b> , FABRIC <b>Flame</b> , FABRIC <b>Ouche</b> , FABRIC <b>Plain</b> , FABRIC <b>Gemma</b> , FABRIC <b>Caltagirone II4</b> | <b>TD</b> | FABRIC <b>Yoredale</b> , FABRIC <b>Remix 3</b>   |
| <b>TE</b> | FABRIC <b>Uniform Melange</b>   | <b>SF</b> | LEATHER <b>Fiore</b>   |
| <b>SV</b> | LEATHER <b>Vintage</b>  |           |  |

**COM/COL - Minimum Q.ty 6 pc. for each material. For weft or patterned fabrics see specific pages**

|   |                        |   |               |
|---|------------------------|---|---------------|
| <b>COM</b><br> | Mtl. 3.70 h. 1.40 Each | <b>COL</b><br> | Mq. 5.20 Each |
|---|------------------------|---|---------------|

**Optionals:**

|              | Value                | Options/notes  |
|--------------|----------------------|--|
| <b>FM-M2</b> | Indoor matt metal M2 | + 63 €<br>ASH GREY <b>ES</b> , BLUE SAPPHIRE <b>EE</b> , BLUE TURQUOISE <b>EH</b> , BRONZE <b>E2</b> , BULGARO RED <b>FP</b> , CHERRY RED <b>EQ</b> , DARK GREEN <b>EL</b> , FACEPOWDER PINK <b>E8</b> , FANGO <b>E3</b> , GOLDEN YELLOW <b>EO</b> , LIGHT BLUE <b>EO</b> , LIGHT GREY <b>ET</b> , OCEAN BLUE <b>EI</b> , OCHER YELLOW <b>E7</b> , PAPAYA ORANGE <b>EA</b> , PASTEL YELLOW <b>E4</b> , PINE GREEN <b>EJ</b> , RED <b>ER</b> , SAGE GREEN <b>E9</b> |
| <b>ES-1</b>  | Fireproof foam       | + 41 €<br>ES-1   |
| <b>PD-F0</b> | Felt pad feet        | + 6 €<br>PD-F0   |

**Dalia DVE\_T**

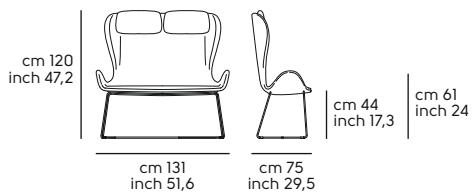

**Dalia DVE\_N**

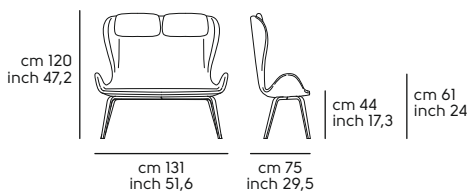

**Dalia Cushion DVE-PE - Upholstered in fabric or leather**

| Model  | Code    | -- | -- | Upholstery |      |      |       |       |      |       |      | Optional | Q.ty | boxes | Kg | M³ |      |
|--|---------|----|----|------------|------|------|-------|-------|------|-------|------|----------|------|-------|----|----|------|
|  |         |    |    | TA         | TB   | TC   | TD    | TE    | SF   | SV    | COM  |          |      |       |    |    | COL  |
|  | A1850Q0 |    |    | 86 €       | 92 € | 96 € | 100 € | 110 € | 98 € | 103 € | 86 € | 96 €     | ES-1 | 1     | 1  | 1  | 0.01 |



**Note:**  
Sold per unit

**Cushion finishes**

**Upholstery**

|           |   |           |  |
|-----------|---|-----------|--|
| <b>TA</b> | FAUX LEATHER <b>Secret</b> , FABRIC <b>Mirage</b> , FABRIC <b>Cotton Club</b> , FABRIC <b>Renewed Loop</b>  | <b>TB</b> | FAUX LEATHER <b>Vintage</b> , FABRIC <b>Fenix Wool</b> , FABRIC <b>Visual</b> , FABRIC <b>Manhattan</b> , FABRIC <b>Novabuk</b> , FABRIC <b>Network</b> , FABRIC <b>Gyre</b> |
| <b>TC</b> | VELVET SUPERB, FABRIC <b>Second</b> , FABRIC <b>Main Line Flax</b> , FABRIC <b>Oceanic</b> , FABRIC <b>Jumper</b> , FABRIC <b>Flame</b> , FABRIC <b>Ouche</b> , FABRIC <b>Plain</b> , FABRIC <b>Gemma</b> , FABRIC <b>Caltagirone 114</b> | <b>TD</b> | FABRIC <b>Yoredale</b> , FABRIC <b>Remix 3</b>   |
| <b>TE</b> | FABRIC <b>Uniform Melange</b>   | <b>SF</b> | LEATHER <b>Fiore</b>   |
| <b>SV</b> | LEATHER <b>Vintage</b>  |           |  |

**COM/COL - Minimum Q.ty 6 pc. for each material. For weft or patterned fabrics see specific pages**

|  |                        |   |               |
|--|------------------------|---|---------------|
|  | Mtl. 0.45 h. 1.40 Each |  | Mq. 0.65 Each |
|--|------------------------|---|---------------|

**Optionals:**





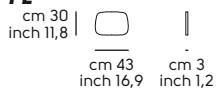

|             | Value          | Options/notes |
|-------------|----------------|---------------|
| <b>ES-1</b> | Fireproof foam | + 5 € ES-1    |

**Dalia Cushion DVE-PE**



**Dalia H65-75-SG - Shell in fabric or leather**

Frame in: metal or wood

| Model   | Code    | Mod.   | Frame | Shell |       |       |       |       |       |       |       |       | Optional               | Q.ty | boxes | Kg    | M <sup>2</sup> |
|---|---------|--------|-------|-------|-------|-------|-------|-------|-------|-------|-------|-------|------------------------|------|-------|-------|----------------|
|   |         |        |       | TA    | TB    | TC    | TD    | TE    | SF    | SV    | COM   | COL   |                        |      |       |       |                |
| <b>Stool DALIA H65 M TS</b><br>  | S1850IQ | H65    | M1    | 428 € | 467 € | 499 € | 515 € | 599 € | 572 € | 631 € | 433 € | 499 € | FM-M2<br>ES-1<br>PD-F0 | 1    | 1     | 8     | 0.29           |
| <b>Stool DALIA H75 M TS</b><br>  | S1850KQ | H75    | M1    | 440 € | 483 € | 513 € | 531 € | 610 € | 587 € | 646 € | 440 € | 513 € | FM-M2<br>ES-1<br>PD-F0 | 1    | 1     | 8     | 0.31           |
| <b>Stool DALIA H65 LR TS</b><br>   | S1850IW | LR H65 | LF1   | 501 € | 540 € | 572 € | 593 € | 673 € | 640 € | 706 € | 501 € | 572 € | ES-1<br>PD-F0          | 1    | 1     | 8     | 0.29           |
| <b>Stool DALIA H75 LR TS</b><br>  | S1850KW | LR H75 | LF1   | 519 € | 560 € | 592 € | 612 € | 691 € | 659 € | 723 € | 519 € | 592 € | ES-1<br>PD-F0          | 1    | 1     | 8     | 0.31           |
| <b>Stool DALIA SG TS</b><br>  | S1850ZT | SG     | M1    | 703 € | 746 € | 777 € | 797 € | 877 € | 842 € | 910 € | 703 € | 777 € | FM-M2<br>ES-1          | 1    | 1     | 16.35 | 0.25           |

**Note:**

TS Front and Back covering available in two-tone or bi-material. Reference price in the upper category

**Frame finishes**

| Metal     |   | Wood       |  |
|-----------|---|------------|--|
| <b>MI</b> | WHITE <b>BB</b> , BROWN <b>E6</b> , SAND <b>EC</b> , WHITE PEARL <b>EF</b> , GRAPHITE <b>EG</b> , BLACK <b>EN</b> | <b>LFI</b> | Ash wood stained BLACK <b>F04</b> , Ash wood stained WHITE <b>F05</b> , Ash wood stained CHERRY RED <b>F09</b> , Ash wood stained FLAMED WALNUT <b>F24</b> , Ash wood stained DARK BROWN <b>F26</b> , Ash wood stained NATURAL <b>F40</b> , Ash wood stained NATURAL OAK <b>F52</b> , Ash wood stained WHITENED <b>F60</b> , Ash wood stained DESERT <b>F61</b> , Ash wood stained LIGHT GREY <b>F62</b> , Ash wood stained DARK GREY <b>F63</b> |

**Shell finishes**

| Upholstery |   |
|------------|---|
| <b>TA</b>  | FAUX LEATHER <b>Secret</b> , FABRIC <b>Mirage</b> , FABRIC <b>Cotton Club</b> , FABRIC <b>Renewed Loop</b>  |
| <b>TC</b>  | VELVET SUPERB, FABRIC <b>Second</b> , FABRIC <b>Main Line Flax</b> , FABRIC <b>Oceanic</b> , FABRIC <b>Jumper</b> , FABRIC <b>Flame</b> , FABRIC <b>Ouche</b> , FABRIC <b>Plain</b> , FABRIC <b>Gemma</b> , FABRIC <b>Caltagirone 114</b> |
| <b>TE</b>  | FABRIC <b>Uniform Melange</b>   |
| <b>SV</b>  | LEATHER <b>Vintage</b>  |
| <b>TB</b>  | FAUX LEATHER <b>Vintage</b> , FABRIC <b>Fenix Wool</b> , FABRIC <b>Visual</b> , FABRIC <b>Manhattan</b> , FABRIC <b>Novabuk</b> , FABRIC <b>Network</b> , FABRIC <b>Gyre</b>  |
| <b>TD</b>  | FABRIC <b>Yoredale</b> , FABRIC <b>Remix 3</b>  |
| <b>SF</b>  | LEATHER <b>Fiore</b>  |

**COM/COL - Minimum Q.ty 6 pc. for each material. For weft or patterned fabrics see specific pages**

|            |                        |            |               |
|------------|------------------------|------------|---------------|
| <b>COM</b> | Mtl. 0.80 h. 1.40 Each | <b>COL</b> | Mq. 1.20 Each |
|------------|------------------------|------------|---------------|

**Optionals:**

|              | Value  | Options/notes  |
|--------------|--------|--|
| <b>FM-M2</b> | + 61 € | ASH GREY <b>ES</b> , BLUE SAPPHIRE <b>EE</b> , BLUE TURQUOISE <b>EH</b> , BRONZE <b>E2</b> , BULGARO RED <b>FP</b> , CHERRY RED <b>EQ</b> , DARK GREEN <b>EL</b> , FACEPOWDER PINK <b>E8</b> , FANGO <b>E3</b> , GOLDEN YELLOW <b>EO</b> , LIGHT BLUE <b>EO</b> , LIGHT GREY <b>ET</b> , OCEAN BLUE <b>E1</b> , OCHER YELLOW <b>E7</b> , PAPAYA ORANGE <b>EA</b> , PASTEL YELLOW <b>E4</b> , PINE GREEN <b>EJ</b> , RED <b>ER</b> , SAGE GREEN <b>E9</b> |
| <b>ES-1</b>  | + 5 €  | ES-1   |
| <b>PD-F0</b> | + 6 €  | PD-F0  |

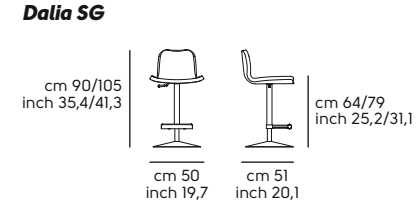
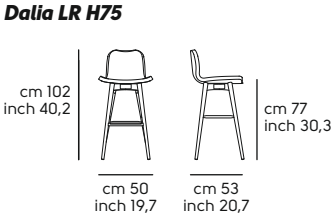
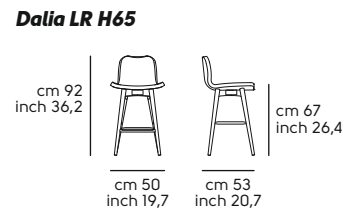
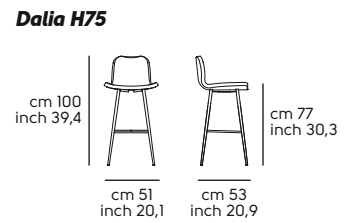
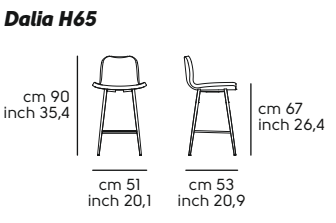

**Pouf DALIA B2 - Cushion in fabric or leather**

Frame in: metal

| Model  | Code     | Mod. | Frame | Cushion |       |       |       |       |       |       |       |       | Optional | Q.ty | boxes | Kg | M <sup>2</sup> |
|--|----------|------|-------|---------|-------|-------|-------|-------|-------|-------|-------|-------|----------|------|-------|----|----------------|
|  |          |      |       | TA      | TB    | TC    | TD    | TE    | SF    | SV    | COM   | COL   |          |      |       |    |                |
| <br><b>Pouf DALIA B2 M TS</b> | S1850B20 | B2   | M1    | 432 €   | 479 € | 552 € | 601 € | 778 € | 542 € | 625 € | 432 € | 552 € | FM-M2    | 1    | 1     | 9  | 0.19           |

Note:

**Frame finishes**

**Metal**



|           |   |
|-----------|---|
| <b>M1</b> | WHITE <b>BB</b> , BROWN <b>E6</b> , SAND <b>EC</b> , WHITE PEARL <b>EF</b> , GRAPHITE <b>EG</b> , BLACK <b>EN</b> |
|-----------|---|

**Seat finishes**

**Upholstery**

|           |   |           |  |
|-----------|---|-----------|--|
| <b>TA</b> | FAUX LEATHER <b>Secret</b> , FABRIC <b>Mirage</b> , FABRIC <b>Cotton Club</b> , FABRIC <b>Renewed Loop</b>  | <b>TB</b> | FAUX LEATHER <b>Vintage</b> , FABRIC <b>Fenix Wool</b> , FABRIC <b>Visual</b> , FABRIC <b>Manhattan</b> , FABRIC <b>Novabuk</b> , FABRIC <b>Network</b> , FABRIC <b>Gyre</b> |
| <b>TC</b> | VELVET SUPERB, FABRIC <b>Second</b> , FABRIC <b>Main Line Flax</b> , FABRIC <b>Oceanic</b> , FABRIC <b>Jumper</b> , FABRIC <b>Flame</b> , FABRIC <b>Ouche</b> , FABRIC <b>Plain</b> , FABRIC <b>Gemma</b> , FABRIC <b>Caltagirone 114</b> | <b>TD</b> | FABRIC <b>Yoredale</b> , FABRIC <b>Remix 3</b>   |
| <b>TE</b> | FABRIC <b>Uniform Melange</b>   | <b>SF</b> | LEATHER <b>Fiore</b>   |
| <b>SV</b> | LEATHER <b>Vintage</b>  |           |  |

**COM/COL - Minimum Q.ty 6 pc. for each material. For weft or patterned fabrics see specific pages**

|  |                        |  |               |
|--|------------------------|--|---------------|
|  <b>COM</b> | Mtl. 0.90 h. 1.40 Each |  <b>COL</b> | Mq. 0.75 Each |
|--|------------------------|--|---------------|

**Optionals:**

|              | Value                | Options/notes  |
|--------------|----------------------|--|
| <b>FM-M2</b> | Indoor matt metal M2 | + 52 €<br>ASH GREY <b>ES</b> , BLUE SAPPHIRE <b>EE</b> , BLUE TURQUOISE <b>EH</b> , BRONZE <b>E2</b> , BULGARO RED <b>FP</b> , CHERRY RED <b>EQ</b> , DARK GREEN <b>EL</b> , FACEPOWDER PINK <b>E8</b> , FANGO <b>E3</b> , GOLDEN YELLOW <b>EO</b> , LIGHT BLUE <b>EO</b> , LIGHT GREY <b>ET</b> , OCEAN BLUE <b>EI</b> , OCHER YELLOW <b>E7</b> , PAPAYA ORANGE <b>EA</b> , PASTEL YELLOW <b>E4</b> , PINE GREEN <b>EJ</b> , RED <b>ER</b> , SAGE GREEN <b>E9</b> |

**DALIA B2**

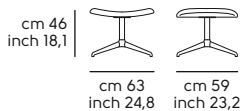

# Danny design Officina delle Idee

## Danny S - Shell in fabric or leather back in wood

Frame in: wood



| Model  | Code    | Mod. | Frame | Shell (Back Shell LII) |       |       |       |       |       |       |       |       | Optional               | Q.ty | boxes | Kg  | M <sup>3</sup> |
|--|---------|------|-------|------------------------|-------|-------|-------|-------|-------|-------|-------|-------|------------------------|------|-------|-----|----------------|
|  |         |      |       | TA                     | TB    | TC    | TD    | TE    | SF    | SV    | COM   | COL   |                        |      |       |     |                |
| <br>Chair DANNY S L TS | S1080W1 | S    | LII   | 646 €                  | 690 € | 711 € | 745 € | 874 € | 831 € | 917 € | 646 € | 711 € | FL-12<br>ES-1<br>PD-FO | 1    | 1     | 8.5 | 0.28           |

COM/COL - Minimum Q.ty 6 pc. for each material. For weft or patterned fabrics see specific pages

|  |  |
|--|--|
| <br>Mtl. 0.75 h. 1.40 Each | <br>Mq. 1.95 Each |
|--|--|

## Danny PB, P - Shell in fabric or leather back in wood

Frame in: wood

| Model  | Code    | Mod. | Frame | Shell (Back Shell LII) |       |       |       |       |       |         |       |       | Optional               | Q.ty | boxes | Kg | M <sup>3</sup> |
|--|---------|------|-------|------------------------|-------|-------|-------|-------|-------|---------|-------|-------|------------------------|------|-------|----|----------------|
|  |         |      |       | TA                     | TB    | TC    | TD    | TE    | SF    | SV      | COM   | COL   |                        |      |       |    |                |
| <br>Armchair DANNY PB L TS | S1080PN | PB   | LII   | 718 €                  | 759 € | 782 € | 811 € | 947 € | 913 € | 1.015 € | 718 € | 782 € | FL-12<br>ES-1<br>PD-FO | 1    | 1     | 9  | 0.32           |
| <br>Armchair DANNY P L TS  | S1080PY | P    | LII   | 743 €                  | 785 € | 807 € | 838 € | 963 € | 933 € | 1.033 € | 743 € | 807 € | FL-12<br>ES-1<br>PD-FO | 1    | 1     | 12 | 0.32           |

COM/COL - Minimum Q.ty 6 pc. for each material. For weft or patterned fabrics see specific pages

|  |  |
|--|--|
| <br>Mtl. 0.90 h. 1.40 Each | <br>Mq. 2.28 Each |
|--|--|

**Frame finishes**

**Wood**

|            |  |
|------------|--|
| <b>L11</b> | Veneered wood painted BLACK <b>I04</b> , Veneered wood painted WHITE <b>I05</b> , Veneered wood painted CHERRY RED <b>I09</b> , Veneered wood painted DARK BROWN <b>I26</b> , Veneered wood painted NATURAL <b>I40</b> , Veneered wood painted NATURAL OAK <b>I52</b> , Veneered wood painted WHITENED <b>I60</b> , Veneered wood painted DESERT <b>I61</b> , Veneered wood painted LIGHT GREY <b>I62</b> , Veneered wood painted DARK GREY <b>I63</b> |
|------------|--|

**Backrest shell finishes**

**Wood**

|            |  |
|------------|--|
| <b>L11</b> | Veneered wood painted BLACK <b>I04</b> , Veneered wood painted WHITE <b>I05</b> , Veneered wood painted CHERRY RED <b>I09</b> , Veneered wood painted DARK BROWN <b>I26</b> , Veneered wood painted NATURAL <b>I40</b> , Veneered wood painted NATURAL OAK <b>I52</b> , Veneered wood painted WHITENED <b>I60</b> , Veneered wood painted DESERT <b>I61</b> , Veneered wood painted LIGHT GREY <b>I62</b> , Veneered wood painted DARK GREY <b>I63</b> |
|------------|--|

**Shell finishes**

**Upholstery**

|           |   |           |  |
|-----------|---|-----------|--|
| <b>TA</b> | FAUX LEATHER <b>Secret</b> , FABRIC <b>Mirage</b> , FABRIC <b>Cotton Club</b> , FABRIC <b>Renewed Loop</b>  | <b>TB</b> | FAUX LEATHER <b>Vintage</b> , FABRIC <b>Fenix Wool</b> , FABRIC <b>Visual</b> , FABRIC <b>Manhattan</b> , FABRIC <b>Novabuk</b> , FABRIC <b>Network</b> , FABRIC <b>Gyre</b> |
| <b>TC</b> | VELVET SUPERB, FABRIC <b>Second</b> , FABRIC <b>Main Line Flax</b> , FABRIC <b>Oceanic</b> , FABRIC <b>Jumper</b> , FABRIC <b>Flame</b> , FABRIC <b>Ouche</b> , FABRIC <b>Plain</b> , FABRIC <b>Gemma</b> , FABRIC <b>Caltagirone 114</b> | <b>TD</b> | FABRIC <b>Yoredale</b> , FABRIC <b>Remix 3</b>   |
| <b>TE</b> | FABRIC <b>Uniform Melange</b>   | <b>SF</b> | LEATHER <b>Fiore</b>   |
| <b>SV</b> | LEATHER <b>Vintage</b>  |           |  |

**Optionals:**

|              |                          | Value  | Options/notes   |
|--------------|--------------------------|--------|---|
| <b>FL-I2</b> | Veneered wood finish L12 | + 6 €  | Veneered wood FLAMED WALNUT <b>I24</b> , Veneered wood NATURAL OAK <b>I22</b> |
| <b>ES-1</b>  | Fireproof foam           | + 21 € | ES-1  |
| <b>PD-F0</b> | Felt pad feet            | + 6 €  | PD-F0   |

**Danny S**

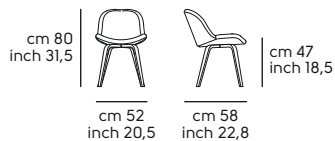

**Danny PB**

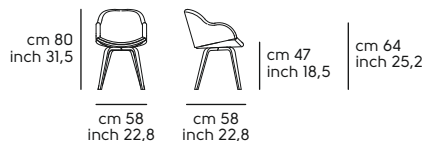



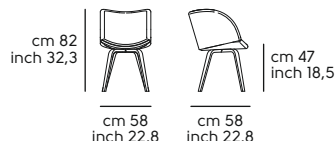

**Danny P**



# Guapa design Sempere e Poli

## Guapa S, P, AP - Shell in hide

Frame in: metal

| Model  | Code    | Mod. | Frame | Shell |         | Optional                | G.ty | boxes | Kg   | M <sup>3</sup> |
|--|---------|------|-------|-------|---------|-------------------------|------|-------|------|----------------|
|  |         |      |       | CK    | CT      |                         |      |       |      |                |
| <b>Chair GUAPA S M CU</b><br>            | S1150SO | S    | M1    | 632 € | 785 €   | FM-M2<br>FM-M3<br>FM-M4 | 2    | 1     | 18   | 0.44           |
| <b>Armchair GUAPA P M CU</b><br>         | S1150PO | P    | M1    | 741 € | 944 €   | FM-M2<br>FM-M3<br>FM-M4 | 1    | 1     | 11.5 | 0.37           |
| <b>Armchair GUAPA P MX CU</b><br>       | S1150PX | MX   | M1    | 904 € | 1.106 € | FM-M2                   | 1    | 1     | 12   | 0.22           |
| <b>Waiting Chair GUAPA AP M CU</b><br> | S1150AC | AP   | M1    | 889 € | 1.192 € | FM-M2<br>FM-M3          | 1    | 1     | 13.5 | 0.46           |

### Frame finishes

#### Metal

**MI** WHITE **BB**, BROWN **E6**, SAND **EC**, WHITE PEARL **EF**, GRAPHITE **EG**, BLACK **EN**

### Shell finishes

#### Upholstery

**CK** HIDE\_TK

**CT** TUSCAN HIDE

### Optionals:

|              |                        | Value   | Options/notes  |
|--------------|------------------------|---------|--|
| <b>FM-M2</b> | Indoor matt metal M2   | + 59 €  | ASH GREY <b>ES</b> , BLUE SAPPHIRE <b>EE</b> , BLUE TURQUOISE <b>EH</b> , BRONZE <b>E2</b> , BULGARO RED <b>FP</b> , CHERRY RED <b>EQ</b> , DARK GREEN <b>EL</b> , FACEPOWDER PINK <b>E8</b> , FANGO <b>E3</b> , GOLDEN YELLOW <b>EO</b> , LIGHT BLUE <b>EO</b> , LIGHT GREY <b>ET</b> , OCEAN BLUE <b>E1</b> , OCHER YELLOW <b>E7</b> , PAPAYA ORANGE <b>EA</b> , PASTEL YELLOW <b>E4</b> , PINE GREEN <b>EJ</b> , RED <b>ER</b> , SAGE GREEN <b>E9</b> |
| <b>FM-M3</b> | Indoor glossy metal M3 | + 26 €  | CHROME <b>CC</b>   |
| <b>FM-M4</b> | Indoor glossy Metal M4 | + 159 € | BLACK NICKEL <b>DZ</b> , CHAMPAGNE GOLD <b>DG</b> , GOLDEN BRONZE <b>DB</b> , MATT BLACK NICKEL <b>DY</b> , MATT GOLDEN BRONZE <b>DC</b> , PINK GOLD <b>DR</b>   |

### Guapa S

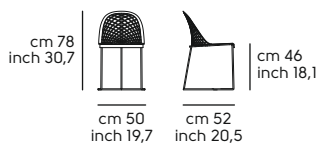

### Guapa P

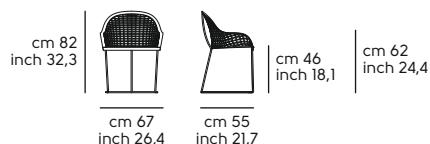

### Guapa MX





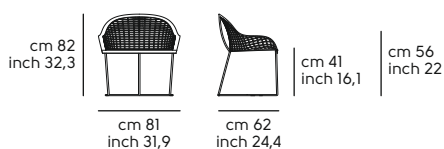

### Guapa AP



**Guapa H65-75, DPB, DPA - Shell in hide**

Frame in: metal

| Model   | Code    | Mod. | Frame | Shell   |         | Optional                | Q.ty | boxes | Kg   | M <sup>2</sup> |
|---|---------|------|-------|---------|---------|-------------------------|------|-------|------|----------------|
|   |         |      |       | CK      | CT      |                         |      |       |      |                |
| <b>Stool GUAPA H65 M CU</b><br>        | S1150H0 | H65  | M1    | 740 €   | 914 €   | FM-M2<br>FM-M3<br>FM-M4 | 1    | 1     | 11   | 0.31           |
| <b>Stool GUAPA H75 M CU</b><br>        | S1150J0 | H75  | M1    | 753 €   | 927 €   | FM-M2<br>FM-M3<br>FM-M4 | 1    | 1     | 11.5 | 0.34           |
| <b>Office Arm. GUAPA DPB M CU</b><br>  | S1150EB | DPB  | M1    | 954 €   | 1.157 € | FM-M2                   | 1    | 2     | 13   | 0.34           |
| <b>Office Arm. GUAPA DPA M CU</b><br> | S1150EA | DPA  | M1    | 1.108 € | 1.359 € | FM-M2                   | 1    | 2     | 17   | 0.44           |

**Frame finishes**

**Metal**

**M1** WHITE **BB**, BROWN **E6**, SAND **EC**, WHITE PEARL **EF**, GRAPHITE **EG**, BLACK **EN**

**Shell finishes**

**Upholstery**

**CK** HIDE\_TK

**CT** TUSCAN HIDE

**Optionals:**

|              |                        | Value   | Options/notes  |
|--------------|------------------------|---------|--|
| <b>FM-M2</b> | Indoor matt metal M2   | + 59 €  | ASH GREY <b>ES</b> , BLUE SAPPHIRE <b>EE</b> , BLUE TURQUOISE <b>EH</b> , BRONZE <b>E2</b> , BULGARO RED <b>FP</b> , CHERRY RED <b>EQ</b> , DARK GREEN <b>EL</b> , FACEPOWDER PINK <b>E8</b> , FANGO <b>E3</b> , GOLDEN YELLOW <b>EO</b> , LIGHT BLUE <b>EO</b> , LIGHT GREY <b>ET</b> , OCEAN BLUE <b>E1</b> , OCHER YELLOW <b>E7</b> , PAPAYA ORANGE <b>EA</b> , PASTEL YELLOW <b>E4</b> , PINE GREEN <b>EJ</b> , RED <b>ER</b> , SAGE GREEN <b>E9</b> |
| <b>FM-M3</b> | Indoor glossy metal M3 | + 26 €  | CHROME <b>CC</b>   |
| <b>FM-M4</b> | Indoor glossy Metal M4 | + 159 € | BLACK NICKEL <b>DZ</b> , CHAMPAGNE GOLD <b>DG</b> , GOLDEN BRONZE <b>DB</b> , MATT BLACK NICKEL <b>DY</b> , MATT GOLDEN BRONZE <b>DC</b> , PINK GOLD <b>DR</b>   |

**Guapa H65**

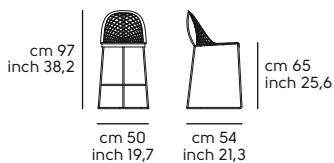

**Guapa H75**

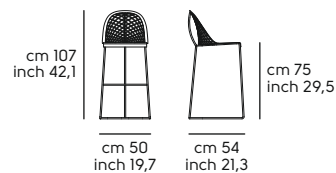

**Guapa DPB**

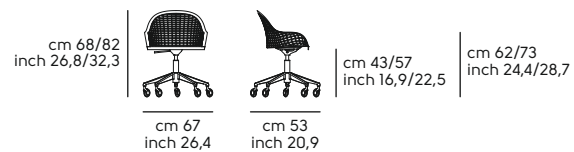

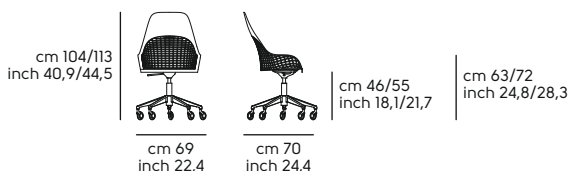

**Guapa DPA**



## Guapa DNB, DNA - Shell in hide

Frame in: metal

| Model   | Code    | Mod. | Frame  | Shell   |         | Optional       | Q.ty | boxes | Kg   | M <sup>3</sup> |
|---|---------|------|--------|---------|---------|----------------|------|-------|------|----------------|
|   |         |      |        | CK      | CT      |                |      |       |      |                |
| <br><b>Rocking GUAPA DNB M CU</b> | S1150RB | DNB  | MI-LFI | 1.020 € | 1.215 € | FM-M2<br>FM-M3 | 1    | 1     | 13.5 | 0.49           |
| <br><b>Rocking GUAPA DNA M CU</b> | S1150RA | DNA  | MI-LFI | 1.197 € | 1.449 € | FM-M2<br>FM-M3 | 1    | 1     | 15   | 0.65           |

### Frame finishes

| Metal     |   |
|-----------|---|
| <b>MI</b> | WHITE <b>BB</b> , BROWN <b>E6</b> , SAND <b>EC</b> , WHITE PEARL <b>EF</b> , GRAPHITE <b>EG</b> , BLACK <b>EN</b> |

### Sledges finishes

| Wood       |  |
|------------|--|
| <b>LFI</b> | Ash wood stained BLACK <b>F04</b> , Ash wood stained WHITE <b>F05</b> , Ash wood stained CHERRY RED <b>F09</b> , Ash wood stained FLAMED WALNUT <b>F24</b> , Ash wood stained DARK BROWN <b>F26</b> , Ash wood stained NATURAL <b>F40</b> , Ash wood stained NATURAL OAK <b>F52</b> , Ash wood stained WHITENED <b>F60</b> , Ash wood stained DESERT <b>F61</b> , Ash wood stained LIGHT GREY <b>F62</b> , Ash wood stained DARK GREY <b>F63</b> |

### Shell finishes

| Upholstery |             |
|------------|-------------|
| <b>CK</b>  | HIDE_TK     |
| <b>CT</b>  | TUSCAN HIDE |

### Optionals:

|              | Value  | Options/notes  |
|--------------|--------|--|
| <b>FM-M2</b> | + 59 € | ASH GREY <b>ES</b> , BLUE SAPPHIRE <b>EE</b> , BLUE TURQUOISE <b>EH</b> , BRONZE <b>E2</b> , BULGARO RED <b>FP</b> , CHERRY RED <b>EQ</b> , DARK GREEN <b>EL</b> , FACEPOWDER PINK <b>E8</b> , FANGO <b>E3</b> , GOLDEN YELLOW <b>EO</b> , LIGHT BLUE <b>ED</b> , LIGHT GREY <b>ET</b> , OCEAN BLUE <b>E1</b> , OCHER YELLOW <b>E7</b> , PAPAYA ORANGE <b>EA</b> , PASTEL YELLOW <b>E4</b> , PINE GREEN <b>EJ</b> , RED <b>ER</b> , SAGE GREEN <b>E9</b> |
| <b>FM-M3</b> | + 26 € | CHROME <b>CC</b>   |

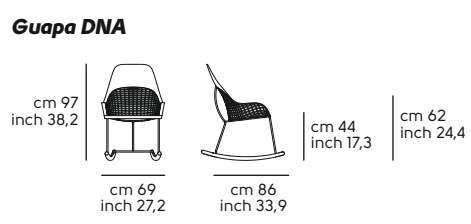
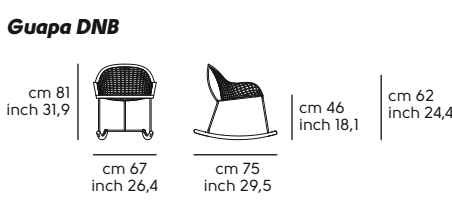



# Joe design Officina delle Idee



## Joe S M - Seat and back in hide, fabric or leather, wood

Frame in: metal

| Model  | Code    | Mod. | Frame | Seat and Backrest |  |  |  |       |  |  |  | Optional               | Q.ty | boxes | Kg | M³   |
|--|---------|------|-------|-------------------|--|--|--|-------|--|--|--|------------------------|------|-------|----|------|
|  |         |      |       | CU                |  |  |  | CT    |  |  |  |                        |      |       |    |      |
| <b>Chair JOE S M CU</b><br> | S1210SQ | S    | MI    | 386 €             |  |  |  | 457 € |  |  |  | FM-M2<br>ES-1<br>PD-FO | 2    | 1     | 12 | 0.32 |



| Model | Code | Mod. | Frame | TA   | TB      | TC | TD | TE    | SF    | SV    | COM   | COL   | Optional | Q.ty | boxes | Kg | M³ |
|-------|------|------|-------|--|---------|----|----|-------|-------|-------|-------|-------|----------|------|-------|----|----|
|       |      |      |       | <b>Chair JOE S MTS</b><br><br> | S1210SR | S  | MI | 289 € | 318 € | 354 € | 385 € | 479 € |          |      |       |    |    |

COM/COL - Minimum Q.ty 6 pc. for each material. Certification IIM available for FAUX LEATHER [Secret]

|  |   |
|--|---|
|  Mtl. 0.70 h. 1.40 Each |  Mq. 1.20 Each |
|--|---|



| Model   | Code    | Mod. | Frame | Seat and Back (Backrest LII) |       |       |       |       |       |       |       | Optional | Q.ty                            | boxes | Kg | M³ |      |
|---|---------|------|-------|------------------------------|-------|-------|-------|-------|-------|-------|-------|----------|---------------------------------|-------|----|----|------|
|   |         |      |       | TA                           | TB    | TC    | TD    | TE    | SF    | SV    | COM   |          |                                 |       |    |    | COL  |
| <b>Chair JOE S MTS/L</b><br> | S1210SS | S    | MI    | 327 €                        | 349 € | 384 € | 411 € | 498 € | 408 € | 442 € | 327 € | 384 €    | FM-M2<br>FL-I2<br>ES-1<br>PD-FO | 2     | 1  | 12 | 0.32 |

COM/COL - Minimum Q.ty 6 pc. for each material. For weft or patterned fabrics see specific pages

|  |   |
|--|---|
|  Mtl. 0.66 h. 1.40 Each |  Mq. 1.07 Each |
|--|---|

| Model  | Code    | Mod. | Frame | Seat (Backrest LII) |       |       |       |       |       |       |       | Optional | Q.ty                            | boxes | Kg | M³ |      |
|--|---------|------|-------|---------------------|-------|-------|-------|-------|-------|-------|-------|----------|---------------------------------|-------|----|----|------|
|  |         |      |       | TA                  | TB    | TC    | TD    | TE    | SF    | SV    | COM   |          |                                 |       |    |    | COL  |
| <b>Chair JOE S MTS-LG</b><br> | S1210SD | S    | MI    | 291 €               | 313 € | 344 € | 369 € | 445 € | 360 € | 384 € | 291 € | 344 €    | FM-M2<br>ES-1<br>FL-I2<br>PD-FO | 2     | 1  | 12 | 0.32 |

COM/COL - Minimum Q.ty 6 pc. for each material. For weft or patterned fabrics see specific pages

|  |   |
|--|---|
|  Mtl. 0.31 h. 1.40 Each |  Mq. 0.52 Each |
|--|---|

| Model   | Code    | Mod. | Frame | Seat and Backrest |       | Optional       | Q.ty | boxes | Kg | M <sup>3</sup> |
|---|---------|------|-------|-------------------|-------|----------------|------|-------|----|----------------|
|   |         |      |       | L11               | L12   |                |      |       |    |                |
| <b>Chair JOE S M LG</b><br> | S1210S0 | S    | M1    | 297 €             | 323 € | FM-M2<br>PD-F0 | 2    | 1     | 12 | 0.32           |

#### Frame finishes

##### Metal

**MI** WHITE **BB**, BROWN **E6**, SAND **EC**, WHITE PEARL **EF**, GRAPHITE **EG**, BLACK **EN**

#### Backrest back finishes

##### Wood

**L11**

Veneered wood painted BLACK **I04**, Veneered wood painted WHITE **I05**, Veneered wood painted CHERRY RED **I09**, Veneered wood painted DARK BROWN **I26**, Veneered wood painted NATURAL **I40**, Veneered wood painted NATURAL OAK **I52**, Veneered wood painted WHITENED **I60**, Veneered wood painted DESERT **I61**, Veneered wood painted LIGHT GREY **I62**, Veneered wood painted DARK GREY **I63**

#### Seat and Back finishes

##### Wood

**L11**

Veneered wood painted BLACK **I04**, Veneered wood painted WHITE **I05**, Veneered wood painted CHERRY RED **I09**, Veneered wood painted DARK BROWN **I26**, Veneered wood painted NATURAL **I40**, Veneered wood painted NATURAL OAK **I52**, Veneered wood painted WHITENED **I60**, Veneered wood painted DESERT **I61**, Veneered wood painted LIGHT GREY **I62**, Veneered wood painted DARK GREY **I63**

**L12**

Veneered wood NATURAL OAK **I22**, Veneered wood FLAMED WALNUT **I24**

#### Upholstery

|           |   |
|-----------|---|
| <b>TA</b> | FAUX LEATHER <b>Secret</b> , FABRIC <b>Mirage</b> , FABRIC <b>Cotton Club</b> , FABRIC <b>Renewed Loop</b>  |
| <b>TC</b> | VELVET SUPERB, FABRIC <b>Second</b> , FABRIC <b>Main Line Flax</b> , FABRIC <b>Oceanic</b> , FABRIC <b>Jumper</b> , FABRIC <b>Flame</b> , FABRIC <b>Ouche</b> , FABRIC <b>Plain</b> , FABRIC <b>Gemma</b> , FABRIC <b>Caltagirone 114</b> |
| <b>TE</b> | FABRIC <b>Uniform Melange</b>   |
| <b>SV</b> | LEATHER <b>Vintage</b>  |
| <b>CT</b> | TUSCAN HIDE   |

|           |  |
|-----------|--|
| <b>TB</b> | FAUX LEATHER <b>Vintage</b> , FABRIC <b>Fenix Wool</b> , FABRIC <b>Visual</b> , FABRIC <b>Manhattan</b> , FABRIC <b>Novabuk</b> , FABRIC <b>Network</b> , FABRIC <b>Gyre</b> |
| <b>TD</b> | FABRIC <b>Yoredale</b> , FABRIC <b>Remix 3</b>   |
| <b>SF</b> | LEATHER <b>Fiore</b>   |
| <b>CU</b> | HIDE   |

#### Optionals:

|              |                          | Value  | Options/notes  |
|--------------|--------------------------|--------|--|
| <b>FM-M2</b> | Indoor matt metal M2     | + 48 € | ASH GREY <b>ES</b> , BLUE SAPPHIRE <b>EE</b> , BLUE TURQUOISE <b>EH</b> , BRONZE <b>E2</b> , BULGARO RED <b>FP</b> , CHERRY RED <b>EQ</b> , DARK GREEN <b>EL</b> , FACEPOWDER PINK <b>E8</b> , FANGO <b>E3</b> , GOLDEN YELLOW <b>EO</b> , LIGHT BLUE <b>EO</b> , LIGHT GREY <b>ET</b> , OCEAN BLUE <b>E1</b> , OCHER YELLOW <b>E7</b> , PAPAYA ORANGE <b>EA</b> , PASTEL YELLOW <b>E4</b> , PINE GREEN <b>EJ</b> , RED <b>ER</b> , SAGE GREEN <b>E9</b> |
| <b>FL-I2</b> | Veneered wood finish L12 | + 21 € | Veneered wood FLAMED WALNUT <b>I24</b> , Veneered wood NATURAL OAK <b>I22</b>  |
| <b>ES-1</b>  | Fireproof foam           | + 5 €  | ES-1   |
| <b>PD-F0</b> | Felt pad feet            | + 6 €  | PD-F0  |

#### Joe S

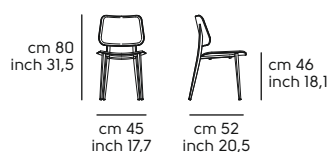

**Joe SL - Seat and back in hide, fabric or leather, wood**



Frame in: wood

| Model   | Code    | Mod. | Frame | Seat and Backrest |  |  |  |       |  |  |  | Optional      | Q.ty | boxes | Kg | M³   |
|---|---------|------|-------|-------------------|--|--|--|-------|--|--|--|---------------|------|-------|----|------|
|   |         |      |       | CU                |  |  |  | CT    |  |  |  |               |      |       |    |      |
| <b>Chair JOE S L CU</b>   |         |      |       |                   |  |  |  |       |  |  |  |               |      |       |    |      |
|  | SI215SQ | S    | LF1   | 434 €             |  |  |  | 503 € |  |  |  | ES-1<br>PD-FO | 2    | 1     | 12 | 0.32 |

| Model   | Code    | Mod. | Frame | TA                      | TB    | TC    | TD    | TE    | SF    | SV    | COM   | COL   | Optional      | Q.ty | boxes | Kg | M³   |
|---|---------|------|-------|-------------------------|-------|-------|-------|-------|-------|-------|-------|-------|---------------|------|-------|----|------|
|   |         |      |       | <b>Chair JOE S L TS</b> |       |       |       |       |       |       |       |       |               |      |       |    |      |
|  | SI215SR | S    | LF1   | 341 €                   | 368 € | 406 € | 425 € | 517 € | 428 € | 469 € | 341 € | 406 € | ES-1<br>PD-FO | 2    | 1     | 12 | 0.32 |





**COM/COL - Minimum Q.ty 6 pc. for each material. For weft or patterned fabrics see specific pages**

|   |                        |   |               |
|---|------------------------|---|---------------|
|  | Mtl. 0.70 h. 1.40 Each |  | Mq. 1.20 Each |
|---|------------------------|---|---------------|



| Model   | Code    | Mod. | Frame | Seat and Back (Backrest LII) |       |       |       |       |       |       |       | Optional | Q.ty          | boxes | Kg | M³ |      |
|---|---------|------|-------|------------------------------|-------|-------|-------|-------|-------|-------|-------|----------|---------------|-------|----|----|------|
|   |         |      |       | TA                           | TB    | TC    | TD    | TE    | SF    | SV    | COM   |          |               |       |    |    | COL  |
| <b>Chair JOE S L TS/L</b>   |         |      |       |                              |       |       |       |       |       |       |       |          |               |       |    |    |      |
|  | SI215SS | S    | LF1   | 375 €                        | 402 € | 440 € | 461 € | 532 € | 454 € | 489 € | 375 € | 440 €    | ES-1<br>PD-FO | 2     | 1  | 12 | 0.32 |

**COM/COL - Minimum Q.ty 6 pc. for each material. For weft or patterned fabrics see specific pages**

|   |                        |   |               |
|---|------------------------|---|---------------|
|  | Mtl. 0.66 h. 1.40 Each |  | Mq. 1.07 Each |
|---|------------------------|---|---------------|

| Model   | Code    | Mod. | Frame | Seat (Backrest LII) |       |       |       |       |       |       |       | Optional | Q.ty          | boxes | Kg | M³ |      |
|---|---------|------|-------|---------------------|-------|-------|-------|-------|-------|-------|-------|----------|---------------|-------|----|----|------|
|   |         |      |       | TA                  | TB    | TC    | TD    | TE    | SF    | SV    | COM   |          |               |       |    |    | COL  |
| <b>Chair JOE S L TS-LG</b>  |         |      |       |                     |       |       |       |       |       |       |       |          |               |       |    |    |      |
|  | SI215SD | S    | LF1   | 355 €               | 370 € | 392 € | 408 € | 454 € | 409 € | 444 € | 355 € | 392 €    | ES-1<br>PD-FO | 2     | 1  | 12 | 0.32 |

**COM/COL - Minimum Q.ty 6 pc. for each material. For weft or patterned fabrics see specific pages**

|   |                        |   |               |
|---|------------------------|---|---------------|
|  | Mtl. 0.31 h. 1.40 Each |  | Mq. 0.52 Each |
|---|------------------------|---|---------------|

| Model   | Code    | Mod. | Seat and Backrest | Frame |  |  |  |  |  |  |  | Optional | Q.ty | boxes | Kg | M³   |
|---|---------|------|-------------------|-------|--|--|--|--|--|--|--|----------|------|-------|----|------|
|   |         |      |                   | LF1   |  |  |  |  |  |  |  |          |      |       |    |      |
| <b>Chair JOE S L LG</b>   |         |      |                   |       |  |  |  |  |  |  |  |          |      |       |    |      |
|  | SI215S0 | S    | LII               | 336 € |  |  |  |  |  |  |  | PD-FO    | 2    | 1     | 12 | 0.32 |

**Frame finishes**

**Wood**

|            |  |
|------------|--|
| <b>LFI</b> | Ash wood stained BLACK <b>F04</b> , Ash wood stained WHITE <b>F05</b> , Ash wood stained CHERRY RED <b>F09</b> , Ash wood stained FLAMED WALNUT <b>F24</b> , Ash wood stained DARK BROWN <b>F26</b> , Ash wood stained NATURAL <b>F40</b> , Ash wood stained NATURAL OAK <b>F52</b> , Ash wood stained WHITENED <b>F60</b> , Ash wood stained DESERT <b>F61</b> , Ash wood stained LIGHT GREY <b>F62</b> , Ash wood stained DARK GREY <b>F63</b> |
|------------|--|

**Backrest back finishes**

**Wood**

|            |  |
|------------|--|
| <b>LII</b> | Veneered wood painted BLACK <b>I04</b> , Veneered wood painted WHITE <b>I05</b> , Veneered wood painted CHERRY RED <b>I09</b> , Veneered wood painted DARK BROWN <b>I26</b> , Veneered wood painted NATURAL <b>I40</b> , Veneered wood painted NATURAL OAK <b>I52</b> , Veneered wood painted WHITENED <b>I60</b> , Veneered wood painted DESERT <b>I61</b> , Veneered wood painted LIGHT GREY <b>I62</b> , Veneered wood painted DARK GREY <b>I63</b> |
|------------|--|

**Seat and Back finishes**

**Wood**

|            |  |
|------------|--|
| <b>LII</b> | Veneered wood painted BLACK <b>I04</b> , Veneered wood painted WHITE <b>I05</b> , Veneered wood painted CHERRY RED <b>I09</b> , Veneered wood painted DARK BROWN <b>I26</b> , Veneered wood painted NATURAL <b>I40</b> , Veneered wood painted NATURAL OAK <b>I52</b> , Veneered wood painted WHITENED <b>I60</b> , Veneered wood painted DESERT <b>I61</b> , Veneered wood painted LIGHT GREY <b>I62</b> , Veneered wood painted DARK GREY <b>I63</b> |
|------------|--|

**Upholstery**

|           |   |           |  |
|-----------|---|-----------|--|
| <b>TA</b> | FAUX LEATHER <b>Secret</b> , FABRIC <b>Mirage</b> , FABRIC <b>Cotton Club</b> , FABRIC <b>Renewed Loop</b>  | <b>TB</b> | FAUX LEATHER <b>Vintage</b> , FABRIC <b>Fenix Wool</b> , FABRIC <b>Visual</b> , FABRIC <b>Manhattan</b> , FABRIC <b>Novabuk</b> , FABRIC <b>Network</b> , FABRIC <b>Gyre</b> |
| <b>TC</b> | VELVET SUPERB, FABRIC <b>Second</b> , FABRIC <b>Main Line Flax</b> , FABRIC <b>Oceanic</b> , FABRIC <b>Jumper</b> , FABRIC <b>Flame</b> , FABRIC <b>Ouche</b> , FABRIC <b>Plain</b> , FABRIC <b>Gemma</b> , FABRIC <b>Caltagirone 114</b> | <b>TD</b> | FABRIC <b>Yoredale</b> , FABRIC <b>Remix 3</b>   |
| <b>TE</b> | FABRIC <b>Uniform Melange</b>   | <b>SF</b> | LEATHER <b>Fiore</b>   |
| <b>SV</b> | LEATHER <b>Vintage</b>  | <b>CU</b> | HIDE   |
| <b>CT</b> | TUSCAN HIDE   |           |  |

**Optionals:**

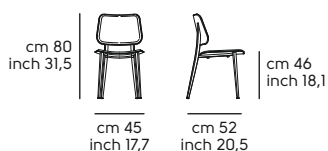

|              |                | Value | Options/notes |
|--------------|----------------|-------|---------------|
| <b>ES-1</b>  | Fireproof foam | + 5 € | ES-1          |
| <b>PD-F0</b> | Felt pad feet  | + 6 € | PD-F0         |

**Joe S**





**Joe H65-75 - Seat and back in hide, fabric or leather, wood**



Frame in: metal

| Model  | Code    | Mod. | Frame | Seat and Backrest |  |  |  |    |  |  |  | Optional               | Q.ty | boxes | Kg  | M³   |
|--|---------|------|-------|-------------------|--|--|--|----|--|--|--|------------------------|------|-------|-----|------|
|  |         |      |       | CU                |  |  |  | CT |  |  |  |                        |      |       |     |      |
| <b>Stool JOE H65 M CU</b><br> | S1210HQ | H65  | M1    |                   |  |  |  |    |  |  |  | FM-M2<br>ES-1<br>PD-F0 | 1    | 1     | 7.5 | 0.27 |
| <b>Stool JOE H75 M CU</b><br> | S1210JQ | H75  | M1    |                   |  |  |  |    |  |  |  | FM-M2<br>ES-1<br>PD-F0 | 1    | 1     | 7.5 | 0.33 |



| Model  | Code    | Mod. | Frame | TA  | TB      | TC    | TD    | TE    | SF    | SV    | COM   | COL   | Optional               | Q.ty | boxes | Kg  | M³   |
|--|---------|------|-------|---|---------|-------|-------|-------|-------|-------|-------|-------|------------------------|------|-------|-----|------|
|  |         |      |       | <b>Stool JOE H65 M TS</b><br><br> | S1210HR | H65   | M1    | 375 € | 404 € | 441 € | 462 € | 537 € |                        |      |       |     |      |
| <b>Stool JOE H75 M TS</b><br><br> | S1210JR | H75  | M1    | 388 €   | 416 €   | 453 € | 473 € | 549 € | 476 € | 517 € | 388 € | 453 € | FM-M2<br>ES-1<br>PD-F0 | 1    | 1     | 7.5 | 0.33 |



**COM/COL - Minimum Q.ty 6 pc. for each material. Certification IIM available for FAUX LEATHER [Secret]**

|  |   |
|--|---|
|  Mtl. 0.70 h. 1.40 Each |  Mq. 1.20 Each |
|--|---|



| Model  | Code    | Mod. | Frame | Seat and Back (Backrest LII) |       |       |       |       |       |       |       | Optional | Q.ty                            | boxes | Kg | M³  |      |
|--|---------|------|-------|------------------------------|-------|-------|-------|-------|-------|-------|-------|----------|---------------------------------|-------|----|-----|------|
|  |         |      |       | TA                           | TB    | TC    | TD    | TE    | SF    | SV    | COM   |          |                                 |       |    |     | COL  |
| <b>Stool JOE H65 M TS/L</b><br> | S1210HS | H65  | M1    | 417 €                        | 443 € | 480 € | 501 € | 550 € | 510 € | 529 € | 417 € | 480 €    | FM-M2<br>FL-I2<br>ES-1<br>PD-F0 | 1     | 1  | 7.5 | 0.27 |
| <b>Stool JOE H75 M TS/L</b><br> | S1210JS | H75  | M1    | 428 €                        | 456 € | 492 € | 513 € | 562 € | 521 € | 540 € | 428 € | 492 €    | FM-M2<br>FL-I2<br>ES-1<br>PD-F0 | 1     | 1  | 7.5 | 0.33 |



**COM/COL - Minimum Q.ty 6 pc. for each material. For weft or patterned fabrics see specific pages**

|  |   |
|--|---|
|  Mtl. 0.66 h. 1.40 Each |  Mq. 1.07 Each |
|--|---|

| Model   | Code    | Mod. | Frame | Seat (Backrest LI1) |       |       |       |       |       |       |       |       | Optional                        | Q.ty | boxes | Kg  | M³   |
|---|---------|------|-------|---------------------|-------|-------|-------|-------|-------|-------|-------|-------|---------------------------------|------|-------|-----|------|
|   |         |      |       | TA                  | TB    | TC    | TD    | TE    | SF    | SV    | COM   | COL   |                                 |      |       |     |      |
|  <b>Stool JOE H65 M TS-LG</b> | S1210HD | H65  | M1    | 364 €               | 383 € | 404 € | 420 € | 467 € | 428 € | 453 € | 364 € | 404 € | FM-M2<br>ES-1<br>FL-I2<br>PD-F0 | 1    | 1     | 7.5 | 0.27 |
|  <b>Stool JOE H75 M TS-LG</b> | S1210JD | H75  | M1    | 374 €               | 393 € | 416 € | 433 € | 479 € | 440 € | 464 € | 374 € | 416 € | FM-M2<br>ES-1<br>FL-I2<br>PD-F0 | 1    | 1     | 7.5 | 0.33 |

**COM/COL - Minimum Q.ty 6 pc. for each material. For weft or patterned fabrics see specific pages**

|   |   |
|---|---|
|  <b>COM</b><br>Mtl. 0.31 h. 1.40 Each |  <b>COL</b><br>Mq. 0.52 Each |
|---|---|

| Model  | Code    | Mod. | Frame | Seat and Backrest |       | Optional       | Q.ty | boxes | Kg  | M³   |
|--|---------|------|-------|-------------------|-------|----------------|------|-------|-----|------|
|  |         |      |       | LI1               | LI2   |                |      |       |     |      |
|  <b>Stool JOE H65 M LG</b>  | S1210H0 | H65  | M1    | 366 €             | 390 € | FM-M2<br>PD-F0 | 1    | 1     | 7.5 | 0.27 |
|  <b>Stool JOE H75 M LG</b> | S1210J0 | H75  | M1    | 380 €             | 406 € | FM-M2<br>PD-F0 | 1    | 1     | 7.5 | 0.33 |

**Frame finishes**

**Metal**

|           |   |
|-----------|---|
| <b>MI</b> | WHITE <b>BB</b> , BROWN <b>E6</b> , SAND <b>EC</b> , WHITE PEARL <b>EF</b> , GRAPHITE <b>EG</b> , BLACK <b>EN</b> |
|-----------|---|

**Backrest back finishes**

**Wood**

|            |  |
|------------|--|
| <b>LII</b> | Veneered wood painted BLACK <b>I04</b> , Veneered wood painted WHITE <b>I05</b> , Veneered wood painted CHERRY RED <b>I09</b> , Veneered wood painted DARK BROWN <b>I26</b> , Veneered wood painted NATURAL <b>I40</b> , Veneered wood painted NATURAL OAK <b>I52</b> , Veneered wood painted WHITENED <b>I60</b> , Veneered wood painted DESERT <b>I61</b> , Veneered wood painted LIGHT GREY <b>I62</b> , Veneered wood painted DARK GREY <b>I63</b> |
|------------|--|

**Seat and Back finishes**

**Wood**

|            |  |            |   |
|------------|--|------------|---|
| <b>LII</b> | Veneered wood painted BLACK <b>I04</b> , Veneered wood painted WHITE <b>I05</b> , Veneered wood painted CHERRY RED <b>I09</b> , Veneered wood painted DARK BROWN <b>I26</b> , Veneered wood painted NATURAL <b>I40</b> , Veneered wood painted NATURAL OAK <b>I52</b> , Veneered wood painted WHITENED <b>I60</b> , Veneered wood painted DESERT <b>I61</b> , Veneered wood painted LIGHT GREY <b>I62</b> , Veneered wood painted DARK GREY <b>I63</b> | <b>L12</b> | Veneered wood NATURAL OAK <b>I22</b> , Veneered wood FLAMED WALNUT <b>I24</b> |
|------------|--|------------|---|

**Upholstery**

|           |   |           |  |
|-----------|---|-----------|--|
| <b>TA</b> | FAUX LEATHER <b>Secret</b> , FABRIC <b>Mirage</b> , FABRIC <b>Cotton Club</b> , FABRIC <b>Renewed Loop</b>  | <b>TB</b> | FAUX LEATHER <b>Vintage</b> , FABRIC <b>Fenix Wool</b> , FABRIC <b>Visual</b> , FABRIC <b>Manhattan</b> , FABRIC <b>Novabuk</b> , FABRIC <b>Network</b> , FABRIC <b>Gyre</b> |
| <b>TC</b> | VELVET SUPERB, FABRIC <b>Second</b> , FABRIC <b>Main Line Flax</b> , FABRIC <b>Oceanic</b> , FABRIC <b>Jumper</b> , FABRIC <b>Flame</b> , FABRIC <b>Ouche</b> , FABRIC <b>Plain</b> , FABRIC <b>Gemma</b> , FABRIC <b>Caltagirone I14</b> | <b>TD</b> | FABRIC <b>Yoredale</b> , FABRIC <b>Remix 3</b>   |
| <b>TE</b> | FABRIC <b>Uniform Melange</b>   | <b>SF</b> | LEATHER <b>Fiore</b>   |
| <b>SV</b> | LEATHER <b>Vintage</b>  | <b>CU</b> | HIDE   |
| <b>CT</b> | TUSCAN HIDE   |           |  |

**Optionals:**

|              |                          | Value  | Options/notes  |
|--------------|--------------------------|--------|--|
| <b>FM-M2</b> | Indoor matt metal M2     | + 48 € | ASH GREY <b>ES</b> , BLUE SAPPHIRE <b>EE</b> , BLUE TURQUOISE <b>EH</b> , BRONZE <b>E2</b> , BULGARO RED <b>FP</b> , CHERRY RED <b>EQ</b> , DARK GREEN <b>EL</b> , FACEPOWDER PINK <b>E8</b> , FANGO <b>E3</b> , GOLDEN YELLOW <b>EO</b> , LIGHT BLUE <b>EO</b> , LIGHT GREY <b>ET</b> , OCEAN BLUE <b>EI</b> , OCHER YELLOW <b>E7</b> , PAPAYA ORANGE <b>EA</b> , PASTEL YELLOW <b>E4</b> , PINE GREEN <b>EJ</b> , RED <b>ER</b> , SAGE GREEN <b>E9</b> |
| <b>FL-I2</b> | Veneered wood finish L12 | + 21 € | Veneered wood FLAMED WALNUT <b>I24</b> , Veneered wood NATURAL OAK <b>I22</b>  |
| <b>ES-1</b>  | Fireproof foam           | + 5 €  | ES-1   |
| <b>PD-F0</b> | Felt pad feet            | + 6 €  | PD-F0  |

**Joe H65**

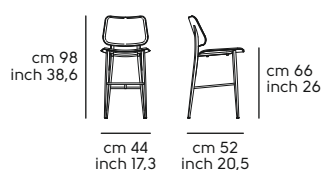

**Joe H75**

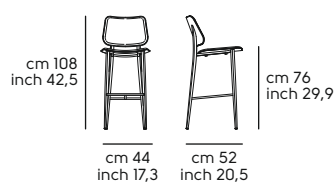

# Kosmos design Karim Rashid

## Kosmos - Seat and back in fabric

| Model  | Code       | Mod. | -- | Seat    |         |         | Optional | G.ty | boxes | Kg | M <sup>3</sup> |
|--|------------|------|----|---------|---------|---------|----------|------|-------|----|----------------|
|  |            |      |    | TB      | TC      | TE      |          |      |       |    |                |
|  Sofa KOSMOS S | S2370DVS00 | S    |    | 1.540 € | 1.586 € | 1.862 € |          | 1    | 1     | 32 | 0.73           |

Note:

--

| Model  | Code       | Mod. | -- | Seat and Backrest |         |         | Optional | G.ty | boxes | Kg   | M <sup>3</sup> |
|--|------------|------|----|-------------------|---------|---------|----------|------|-------|------|----------------|
|  |            |      |    | TB                | TC      | TE      |          |      |       |      |                |
|  Sofa KOSMOS SB | S2370DVS01 | SB   |    | 1.869 €           | 1.924 € | 2.408 € |          | 1    | 2     | 38.5 | 0.78           |

Note:

--

| Model  | Code       | Mod. | -- | Seat    |         |         | Optional | G.ty | boxes | Kg | M <sup>3</sup> |
|--|------------|------|----|---------|---------|---------|----------|------|-------|----|----------------|
|  |            |      |    | TB      | TC      | TE      |          |      |       |    |                |
|  Sofa KOSMOS M | S2370DVM00 | M    |    | 2.459 € | 2.532 € | 4.233 € |          | 1    | 1     | 52 | 1.08           |

Note:

--

| Model   | Code       | Mod. | -- | Seat and Backrest |         |         | Optional | G.ty | boxes | Kg | M <sup>3</sup> |
|---|------------|------|----|-------------------|---------|---------|----------|------|-------|----|----------------|
|   |            |      |    | TB                | TC      | TE      |          |      |       |    |                |
|  Sofa KOSMOS MB | S2370DVM01 | MB   |    | 2.904 €           | 2.990 € | 4.883 € |          | 1    | 2     | 61 | 1.14           |

Note:

--

| Model  | Code       | Mod. | -- | Seat    |         |         | Optional | G.ty | boxes | Kg | M <sup>3</sup> |
|--|------------|------|----|---------|---------|---------|----------|------|-------|----|----------------|
|  |            |      |    | TB      | TC      | TE      |          |      |       |    |                |
|  Sofa KOSMOS L | S2370DVL00 | L    |    | 2.884 € | 2.969 € | 4.553 € |          | 1    | 1     | 67 | 1.37           |

Note:  
--

| Model  | Code       | Mod. | -- | Seat and Backrest |         |         | Optional | Q.ty | boxes | Kg   | M³   |
|--|------------|------|----|-------------------|---------|---------|----------|------|-------|------|------|
|  |            |      |    | TB                | TC      | TE      |          |      |       |      |      |
| <b>Sofa KOSMOS LB</b><br> | S2370DVL01 | LB   |    | 3.883 €           | 3.999 € | 5.990 € |          | 1    | 2     | 88.5 | 1.56 |

Note:  
--

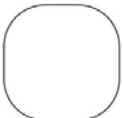
| Model  | Code    | Mod. | -- | Upholstery |       |       | Optional | Q.ty | boxes | Kg   | M³   |
|--|---------|------|----|------------|-------|-------|----------|------|-------|------|------|
|  |         |      |    | TB         | TC    | TE    |          |      |       |      |      |
| <b>Cushion KOSMOS S</b><br> | A2370Q0 | S    |    | 202 €      | 208 € | 291 € |          | 1    | 1     | 0.90 | 0.01 |

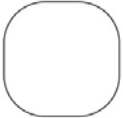
| Model  | Code    | Mod. | -- | Upholstery |       |       | Optional | Q.ty | boxes | Kg | M³   |
|--|---------|------|----|------------|-------|-------|----------|------|-------|----|------|
|  |         |      |    | TB         | TC    | TE    |          |      |       |    |      |
| <b>Cushion KOSMOS L</b><br> | A2370Q1 | L    |    | 202 €      | 208 € | 291 € |          | 1    | 1     | 1  | 0.02 |

Note:  
--

**Seat and Back and Cushion finishes**

**Upholstery**

|           |                               |           |               |
|-----------|-------------------------------|-----------|---------------|
| <b>TB</b> | FABRIC Visual, FABRIC Network | <b>TC</b> | FABRIC Jumper |
| <b>TE</b> | FABRIC Uniform Melange        |           |               |

**Kosmos S**

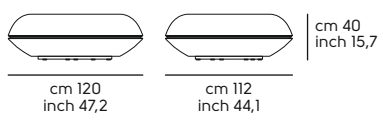

**Kosmos SB**

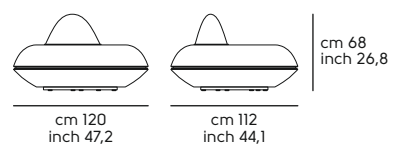

**Kosmos M**

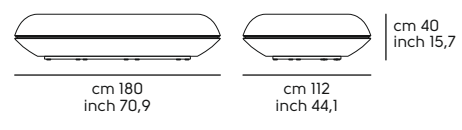

**Kosmos MB**

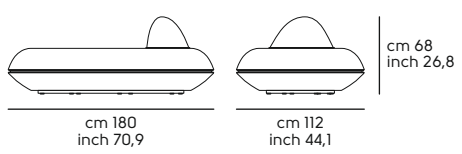

**Kosmos L**

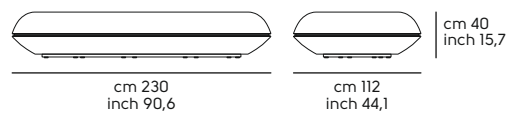

**Kosmos LB**

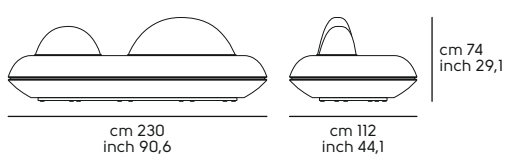

**Kosmos Cushion S**

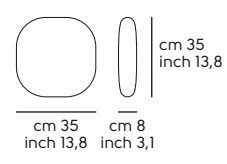

**Kosmos Cushion L**

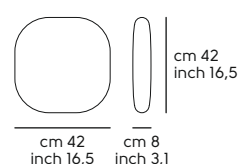

# Lea design Paolo Vernier

## Lea S, P - Shell in hide, fabric or leather, back in veneered wood

Frame in: metal

| Model  | Code    | Mod. | Frame | Shell |  |  |  |    |  |  |  | Optional | Q.ty | boxes                           | Kg     | M <sup>3</sup> |           |              |
|--|---------|------|-------|-------|--|--|--|----|--|--|--|----------|------|---------------------------------|--------|----------------|-----------|--------------|
|  |         |      |       | CU    |  |  |  | CT |  |  |  |          |      |                                 |        |                |           |              |
| <b>Chair LEA S M CU</b>  |         |      |       |       |  |  |  |    |  |  |  |          |      |                                 |        |                |           |              |
|  | S1940SC | S    | MI    |       |  |  |  |    |  |  |  |          |      | FM-M2<br>FM-M4<br>ES-1<br>PD-FO | 1<br>2 | 1<br>1         | 8<br>16.0 | 0.30<br>0.43 |
|  |         |      |       |       |  |  |  |    |  |  |  |          |      |                                 |        |                |           |              |

| Model  | Code    | Mod. | Frame | TA    | TB    | TC    | TD    | TE    | SF    | SV    | COM   | COL   | Optional                        | Q.ty   | boxes  | Kg          | M <sup>3</sup> |
|--|---------|------|-------|-------|-------|-------|-------|-------|-------|-------|-------|-------|---------------------------------|--------|--------|-------------|----------------|
|  |         |      |       |       |       |       |       |       |       |       |       |       |                                 |        |        |             |                |
| <b>Chair LEA S M TS</b>  |         |      |       |       |       |       |       |       |       |       |       |       |                                 |        |        |             |                |
|  | S1940ST | S    | MI    | 394 € | 443 € | 485 € | 510 € | 622 € | 519 € | 562 € | 401 € | 485 € | FM-M2<br>FM-M4<br>ES-1<br>PD-FO | 1<br>2 | 1<br>1 | 9.4<br>18.8 | 0.30<br>0.43   |
|  |         |      |       |       |       |       |       |       |       |       |       |       |                                 |        |        |             |                |

COM/COL - Minimum Q.ty 6 pc. for each material. Certification IIM available for FAUX LEATHER [Secret]

|   |                        |  |               |
|---|------------------------|--|---------------|
|  | Mtl. 1.10 h. 1.40 Each |  | Mq. 2.00 Each |
|---|------------------------|--|---------------|

| Model  | Code    | Mod. | Frame | Shell (Back Shell LII) |       |       |       |       |       |       |       | Optional | Q.ty                                     | boxes  | Kg     | M <sup>3</sup> |              |
|--|---------|------|-------|------------------------|-------|-------|-------|-------|-------|-------|-------|----------|--|--------|--------|----------------|--------------|
|  |         |      |       | TA                     | TB    | TC    | TD    | TE    | SF    | SV    | COM   |          |  |        |        |                | COL          |
| <b>Chair LEA S M TS/L</b>  |         |      |       |                        |       |       |       |       |       |       |       |          |  |        |        |                |              |
|  | S1940SL | S    | MI    | 489 €                  | 518 € | 557 € | 566 € | 641 € | 600 € | 643 € | 498 € | 557 €    | FM-M2<br>FM-M4<br>FL-I2<br>ES-1<br>PD-FO | 1<br>2 | 1<br>1 | 8<br>16.0      | 0.30<br>0.43 |
|  |         |      |       |                        |       |       |       |       |       |       |       |          |  |        |        |                |              |



COM/COL - Minimum Q.ty 6 pc. for each material. For weft or patterned fabrics see specific pages

|  |                        |   |               |
|--|------------------------|---|---------------|
|  | Mtl. 0.72 h. 1.40 Each |  | Mq. 1.30 Each |
|--|------------------------|---|---------------|

| Model  | Code    | Mod. | Frame | Shell |  |  |  |    |  |  |  | Optional | Q.ty                            | boxes | Kg | M <sup>3</sup> |      |
|--|---------|------|-------|-------|--|--|--|----|--|--|--|----------|---------------------------------|-------|----|----------------|------|
|  |         |      |       | CU    |  |  |  | CT |  |  |  |          |                                 |       |    |                |      |
| <b>Armchair LEA P M CU</b>   |         |      |       |       |  |  |  |    |  |  |  |          |                                 |       |    |                |      |
|  | S1940PC | P    | MI    |       |  |  |  |    |  |  |  |          | FM-M2<br>FM-M4<br>ES-1<br>PD-FO | 1     | 1  | 10             | 0.37 |
|  |         |      |       |       |  |  |  |    |  |  |  |          |                                 |       |    |                |      |



| Model  | Code    | Mod. | Frame | TA    | TB    | TC    | TD    | TE    | SF    | SV    | COM   | COL   | Optional                        | Q.ty | boxes | Kg | M <sup>3</sup> |
|--|---------|------|-------|-------|-------|-------|-------|-------|-------|-------|-------|-------|---------------------------------|------|-------|----|----------------|
|  |         |      |       |       |       |       |       |       |       |       |       |       |                                 |      |       |    |                |
| <b>Armchair LEA P M TS</b>   |         |      |       |       |       |       |       |       |       |       |       |       |                                 |      |       |    |                |
|  | S1940PT | P    | MI    | 498 € | 539 € | 593 € | 665 € | 828 € | 648 € | 764 € | 508 € | 593 € | FM-M2<br>FM-M4<br>ES-1<br>PD-FO | 1    | 1     | 11 | 0.37           |
|  |         |      |       |       |       |       |       |       |       |       |       |       |                                 |      |       |    |                |

COM/COL - Minimum Q.ty 6 pc. for each material. For weft or patterned fabrics see specific pages

|  |   |
|--|---|
|  Mtl. 1.60 h. 1.40 Each |  Mq. 2.85 Each |
|--|---|

| Model   | Code    | Mod. | Frame | Shell (Back Shell LII) |       |       |       |       |       |       |       | Optional | Q.ty                                     | boxes | Kg | M³ |      |
|---|---------|------|-------|------------------------|-------|-------|-------|-------|-------|-------|-------|----------|--|-------|----|----|------|
|   |         |      |       | TA                     | TB    | TC    | TD    | TE    | SF    | SV    | COM   |          |  |       |    |    | COL  |
|  | S1940PL | P    | M1    | 607 €                  | 649 € | 692 € | 745 € | 872 € | 720 € | 764 € | 619 € | 692 €    | FM-M2<br>FM-M4<br>FL-I2<br>ES-1<br>PD-F0 | 1     | 1  | 10 | 0.37 |

COM/COL - Minimum Q.ty 6 pc. for each material. For weft or patterned fabrics see specific pages

|  |   |
|--|---|
|  Mtl. 1.25 h. 1.40 Each |  Mq. 2.10 Each |
|--|---|

Note:

TS Front and Back covering available in two-tone or bi-material. Reference price in the upper category - Only Model M TS

Frame finishes

Metal

|           |   |
|-----------|---|
| <b>MI</b> | WHITE <b>BB</b> , BROWN <b>E6</b> , SAND <b>EC</b> , WHITE PEARL <b>EF</b> , GRAPHITE <b>EG</b> , BLACK <b>EN</b> |
|-----------|---|

Backrest shell finishes

Wood

|            |  |
|------------|--|
| <b>LII</b> | Veneered wood painted BLACK <b>I04</b> , Veneered wood painted WHITE <b>I05</b> , Veneered wood painted CHERRY RED <b>I09</b> , Veneered wood painted DARK BROWN <b>I26</b> , Veneered wood painted NATURAL <b>I40</b> , Veneered wood painted NATURAL OAK <b>I52</b> , Veneered wood painted WHITENED <b>I60</b> , Veneered wood painted DESERT <b>I61</b> , Veneered wood painted LIGHT GREY <b>I62</b> , Veneered wood painted DARK GREY <b>I63</b> |
|------------|--|

Shell finishes

Upholstery

|           |   |           |  |
|-----------|---|-----------|--|
| <b>TA</b> | FAUX LEATHER <b>Secret</b> , FABRIC <b>Mirage</b> , FABRIC <b>Cotton Club</b> , FABRIC <b>Renewed Loop</b>  | <b>TB</b> | FAUX LEATHER <b>Vintage</b> , FABRIC <b>Fenix Wool</b> , FABRIC <b>Visual</b> , FABRIC <b>Manhattan</b> , FABRIC <b>Novabuk</b> , FABRIC <b>Network</b> , FABRIC <b>Gyre</b> |
| <b>TC</b> | VELVET SUPERB, FABRIC <b>Second</b> , FABRIC <b>Main Line Flax</b> , FABRIC <b>Oceanic</b> , FABRIC <b>Jumper</b> , FABRIC <b>Flame</b> , FABRIC <b>Ouche</b> , FABRIC <b>Plain</b> , FABRIC <b>Gemma</b> , FABRIC <b>Caltagirone II4</b> | <b>TD</b> | FABRIC <b>Yoredale</b> , FABRIC <b>Remix 3</b>   |
| <b>TE</b> | FABRIC <b>Uniform Melange</b>   | <b>SF</b> | LEATHER <b>Fiore</b>   |
| <b>SV</b> | LEATHER <b>Vintage</b>  | <b>CU</b> | HIDE   |
| <b>CT</b> | TUSCAN HIDE   |           |  |

Optionals:

|              |                          | Value   | Options/notes  |
|--------------|--------------------------|---------|--|
| <b>FM-M2</b> | Indoor matt metal M2     | + 54 €  | ASH GREY <b>ES</b> , BLUE SAPPHIRE <b>EE</b> , BLUE TURQUOISE <b>EH</b> , BRONZE <b>E2</b> , BULGARO RED <b>FP</b> , CHERRY RED <b>EQ</b> , DARK GREEN <b>EL</b> , FACEPOWDER PINK <b>E8</b> , FANGO <b>E3</b> , GOLDEN YELLOW <b>EO</b> , LIGHT BLUE <b>EO</b> , LIGHT GREY <b>ET</b> , OCEAN BLUE <b>EI</b> , OCHER YELLOW <b>E7</b> , PAPAYA ORANGE <b>EA</b> , PASTEL YELLOW <b>E4</b> , PINE GREEN <b>EJ</b> , RED <b>ER</b> , SAGE GREEN <b>E9</b> |
| <b>FM-M4</b> | Indoor glossy Metal M4   | + 123 € | BLACK NICKEL <b>DZ</b> , CHAMPAGNE GOLD <b>DG</b> , GOLDEN BRONZE <b>DB</b> , MATT BLACK NICKEL <b>DY</b> , MATT GOLDEN BRONZE <b>DC</b> , PINK GOLD <b>DR</b>   |
| <b>FL-I2</b> | Veneered wood finish LI2 | + 16 €  | Veneered wood FLAMED WALNUT <b>I24</b> , Veneered wood NATURAL OAK <b>I22</b>  |
| <b>ES-1</b>  | Fireproof foam           | + 21 €  | ES-1   |
| <b>PD-F0</b> | Felt pad feet            | + 6 €   | PD-F0  |

Lea S

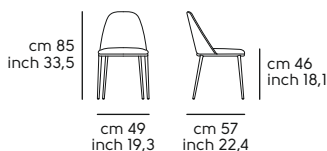

Lea P

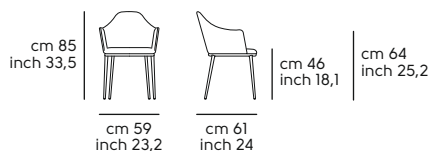



**Lea S, P - Shell in hide, fabric or leather, back in veneered wood**

Frame in: metal

| Model  | Code     | Mod. | Frame | Shell |    |  |  |  |  |  |  | Optional | Q.ty          | boxes | Kg | M³   |      |
|--|----------|------|-------|-------|----|--|--|--|--|--|--|----------|---------------|-------|----|------|------|
|  |          |      |       | CU    | CT |  |  |  |  |  |  |          |               |       |    |      |      |
|  | S1940SYC | GX   | MI    | 799 € |    |  |  |  |  |  |  | 1.040 €  | FM-M2<br>ES-1 | 1     | 1  | 11.9 | 0.27 |



| Model | Code | Mod. | Frame | TA   | TB       | TC | TD | TE    | SF    | SV    | COM   | COL   | Optional | Q.ty | boxes | Kg | M³ |
|-------|------|------|-------|--|----------|----|----|-------|-------|-------|-------|-------|----------|------|-------|----|----|
|       |      |      |       |  | S1940SYT | GX | MI | 642 € | 686 € | 728 € | 753 € | 864 € |          |      |       |    |    |

**COM/COL - Minimum Q.ty 6 pc. for each material. Certification IIM available for FAUX LEATHER [Secret]**

|   |   |
|---|---|
|  Mtl. 1.10 h. 1.40 Each |  Mq. 2.00 Each |
|---|---|

| Model  | Code     | Mod. | Frame | Shell (Back Shell LII) |       |       |       |       |       |       |       | Optional | Q.ty                   | boxes | Kg | M³   |      |
|--|----------|------|-------|------------------------|-------|-------|-------|-------|-------|-------|-------|----------|------------------------|-------|----|------|------|
|  |          |      |       | TA                     | TB    | TC    | TD    | TE    | SF    | SV    | COM   |          |                        |       |    |      | COL  |
|  | S1940SYL | GX   | MI    | 720 €                  | 761 € | 802 € | 809 € | 883 € | 842 € | 885 € | 734 € | 802 €    | FM-M2<br>FL-I2<br>ES-1 | 1     | 1  | 11.9 | 0.27 |



**COM/COL - Minimum Q.ty 6 pc. for each material. For weft or patterned fabrics see specific pages**

|   |   |
|---|---|
|  Mtl. 0.72 h. 1.40 Each |  Mq. 1.30 Each |
|---|---|

| Model  | Code     | Mod. | Frame | Shell |    |  |  |  |  |  |  | Optional | Q.ty          | boxes | Kg | M³   |      |
|--|----------|------|-------|-------|----|--|--|--|--|--|--|----------|---------------|-------|----|------|------|
|  |          |      |       | CU    | CT |  |  |  |  |  |  |          |               |       |    |      |      |
|  | S1940PYC | GX   | MI    | 992 € |    |  |  |  |  |  |  | 1.320 €  | FM-M2<br>ES-1 | 1     | 1  | 14.2 | 0.32 |



| Model | Code | Mod. | Frame | TA   | TB       | TC | TD | TE    | SF    | SV    | COM   | COL     | Optional | Q.ty | boxes | Kg | M³ |
|-------|------|------|-------|--|----------|----|----|-------|-------|-------|-------|---------|----------|------|-------|----|----|
|       |      |      |       |  | S1940PYT | GX | MI | 734 € | 783 € | 835 € | 907 € | 1.050 € |          |      |       |    |    |

**COM/COL - Minimum Q.ty 6 pc. for each material. For weft or patterned fabrics see specific pages**

|   |   |
|---|---|
|  Mtl. 1.60 h. 1.40 Each |  Mq. 2.85 Each |
|---|---|

| Model  | Code     | Mod. | Frame | Shell (Back Shell LII) |       |       |       |         |       |         |       |       | Optional               | Q.ty | boxes | Kg   | M³   |
|--|----------|------|-------|------------------------|-------|-------|-------|---------|-------|---------|-------|-------|------------------------|------|-------|------|------|
|  |          |      |       | TA                     | TB    | TC    | TD    | TE      | SF    | SV      | COM   | COL   |                        |      |       |      |      |
| <br>Armch. with self-return LEA P GX TS/L | S1940PYL | GX   | M1    | 860 €                  | 893 € | 934 € | 988 € | 1.115 € | 963 € | 1.008 € | 860 € | 934 € | FM-M2<br>FL-12<br>ES-1 | 1    | 1     | 14.2 | 0.32 |

**COM/COL - Minimum Q.ty 6 pc. for each material. For weft or patterned fabrics see specific pages**

|  |   |
|--|---|
|  Mtl. 1.25 h. 1.40 Each |  Mq. 2.10 Each |
|--|---|

**Note:**

TS Front and Back covering available in two-tone or bi-material. Reference price in the upper category - Only Model GX TS

**Frame finishes**

**Metal**

**MI** WHITE **BB**, BROWN **E6**, SAND **EC**, WHITE PEARL **EF**, GRAPHITE **EG**, BLACK **EN**

**Backrest shell finishes**

**Wood**

**LII** Veneered wood painted BLACK **I04**, Veneered wood painted WHITE **I05**, Veneered wood painted CHERRY RED **I09**, Veneered wood painted DARK BROWN **I26**, Veneered wood painted NATURAL **I40**, Veneered wood painted NATURAL OAK **I52**, Veneered wood painted WHITENED **I60**, Veneered wood painted DESERT **I61**, Veneered wood painted LIGHT GREY **I62**, Veneered wood painted DARK GREY **I63**

**Shell finishes**

**Upholstery**

|           |   |           |  |
|-----------|---|-----------|--|
| <b>TA</b> | FAUX LEATHER <b>Secret</b> , FABRIC <b>Mirage</b> , FABRIC <b>Cotton Club</b> , FABRIC <b>Renewed Loop</b>  | <b>TB</b> | FAUX LEATHER <b>Vintage</b> , FABRIC <b>Fenix Wool</b> , FABRIC <b>Visual</b> , FABRIC <b>Manhattan</b> , FABRIC <b>Novabuk</b> , FABRIC <b>Network</b> , FABRIC <b>Gyre</b> |
| <b>TC</b> | VELVET SUPERB, FABRIC <b>Second</b> , FABRIC <b>Main Line Flax</b> , FABRIC <b>Oceanic</b> , FABRIC <b>Jumper</b> , FABRIC <b>Flame</b> , FABRIC <b>Ouche</b> , FABRIC <b>Plain</b> , FABRIC <b>Gemma</b> , FABRIC <b>Caltagirone I14</b> | <b>TD</b> | FABRIC <b>Yoredale</b> , FABRIC <b>Remix 3</b>   |
| <b>TE</b> | FABRIC <b>Uniform Melange</b>   | <b>SF</b> | LEATHER <b>Fiore</b>   |
| <b>SV</b> | LEATHER <b>Vintage</b>  | <b>CU</b> | HIDE   |
| <b>CT</b> | TUSCAN HIDE   |           |  |

**Optionals:**

|              | Value  | Options/notes  |
|--------------|--------|--|
| <b>FM-M2</b> | + 61 € | ASH GREY <b>ES</b> , BLUE SAPPHIRE <b>EE</b> , BLUE TURQUOISE <b>EH</b> , BRONZE <b>E2</b> , BULGARO RED <b>FP</b> , CHERRY RED <b>EQ</b> , DARK GREEN <b>EL</b> , FACEPOWDER PINK <b>E8</b> , FANGO <b>E3</b> , GOLDEN YELLOW <b>EO</b> , LIGHT BLUE <b>EO</b> , LIGHT GREY <b>ET</b> , OCEAN BLUE <b>E1</b> , OCHER YELLOW <b>E7</b> , PAPAYA ORANGE <b>EA</b> , PASTEL YELLOW <b>E4</b> , PINE GREEN <b>EJ</b> , RED <b>ER</b> , SAGE GREEN <b>E9</b> |
| <b>FL-12</b> | + 18 € | Veneered wood FLAMED WALNUT <b>I24</b> , Veneered wood NATURAL OAK <b>I22</b>  |
| <b>ES-1</b>  | + 21 € | ES-1   |

**Lea S GX**

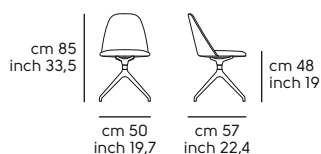

**Lea P GX**

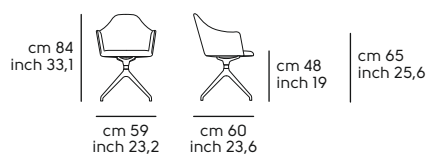



**Lea AP, DV - Shell in fabric or leather**

Frame in: metal



| Model  | Code    | Mod. | Frame | Shell |       |       |       |         |       |         |       |       | Optional                        | Q.ty | boxes | Kg | M³   |
|--|---------|------|-------|-------|-------|-------|-------|---------|-------|---------|-------|-------|---------------------------------|------|-------|----|------|
|  |         |      |       | TA    | TB    | TC    | TD    | TE      | SF    | SV      | COM   | COL   |                                 |      |       |    |      |
| <b>Waiting Chair LEA AP M TS</b><br> | S1940AT | AP   | MI    | 744 € | 795 € | 865 € | 907 € | 1.077 € | 920 € | 1.000 € | 744 € | 865 € | FM-M2<br>FM-M4<br>ES-1<br>PD-F0 | 1    | 1     | 12 | 0.36 |

**COM/COL - Minimum Q.ty 6 pc. for each material. For weft or patterned fabrics see specific pages**

|   |   |
|---|---|
|  Mtl. 1.65 h. 1.40 Each |  Mq. 3.00 Each |
|---|---|

| Model   | Code    | Mod. | Frame | Shell   |         |         |         |         |         |         |         |         | Optional                        | Q.ty | boxes | Kg | M³   |
|---|---------|------|-------|---------|---------|---------|---------|---------|---------|---------|---------|---------|---------------------------------|------|-------|----|------|
|   |         |      |       | TA      | TB      | TC      | TD      | TE      | SF      | SV      | COM     | COL     |                                 |      |       |    |      |
| <b>Sofa LEA DV M TS</b><br> | S1940LT | DV   | MI    | 1.041 € | 1.173 € | 1.239 € | 1.320 € | 1.588 € | 1.541 € | 1.728 € | 1.041 € | 1.239 € | FM-M2<br>FM-M4<br>ES-1<br>PD-F0 | 1    | 1     | 22 | 0.69 |

**COM/COL - Minimum Q.ty 6 pc. for each material. For weft or patterned fabrics see specific pages**

|   |   |
|---|---|
|  Mtl. 2.65 h. 1.40 Each |  Mq. 4.80 Each |
|---|---|

**Note:**

TS Front and Back covering available in two-tone or bi-material. Reference price in the upper category

**Frame finishes**

**Metal**

|           |   |
|-----------|---|
| <b>MI</b> | WHITE <b>BB</b> , BROWN <b>E6</b> , SAND <b>EC</b> , WHITE PEARL <b>EF</b> , GRAPHITE <b>EG</b> , BLACK <b>EN</b> |
|-----------|---|

**Shell finishes**

**Upholstery**

|           |   |           |  |
|-----------|---|-----------|--|
| <b>TA</b> | FAUX LEATHER <b>Secret</b> , FABRIC <b>Mirage</b> , FABRIC <b>Cotton Club</b> , FABRIC <b>Renewed Loop</b>  | <b>TB</b> | FAUX LEATHER <b>Vintage</b> , FABRIC <b>Fenix Wool</b> , FABRIC <b>Visual</b> , FABRIC <b>Manhattan</b> , FABRIC <b>Novabuk</b> , FABRIC <b>Network</b> , FABRIC <b>Gyre</b> |
| <b>TC</b> | VELVET SUPERB, FABRIC <b>Second</b> , FABRIC <b>Main Line Flax</b> , FABRIC <b>Oceanic</b> , FABRIC <b>Jumper</b> , FABRIC <b>Flame</b> , FABRIC <b>Ouche</b> , FABRIC <b>Plain</b> , FABRIC <b>Gemma</b> , FABRIC <b>Caltagirone 114</b> | <b>TD</b> | FABRIC <b>Yoredale</b> , FABRIC <b>Remix 3</b>   |
| <b>TE</b> | FABRIC <b>Uniform Melange</b>   | <b>SF</b> | LEATHER <b>Fiore</b>   |
| <b>SV</b> | LEATHER <b>Vintage</b>  |           |  |

**Optionals:**

|              | Value   | Options/notes  |
|--------------|---------|--|
| <b>FM-M2</b> | + 69 €  | Indoor matt metal M2<br>ASH GREY <b>ES</b> , BLUE SAPPHIRE <b>EE</b> , BLUE TURQUOISE <b>EH</b> , BRONZE <b>E2</b> , BULGARO RED <b>FP</b> , CHERRY RED <b>EQ</b> , DARK GREEN <b>EL</b> , FACEPOWDER PINK <b>E8</b> , FANGO <b>E3</b> , GOLDEN YELLOW <b>EO</b> , LIGHT BLUE <b>EO</b> , LIGHT GREY <b>ET</b> , OCEAN BLUE <b>EI</b> , OCHER YELLOW <b>E7</b> , PAPAYA ORANGE <b>EA</b> , PASTEL YELLOW <b>E4</b> , PINE GREEN <b>EJ</b> , RED <b>ER</b> , SAGE GREEN <b>E9</b> |
| <b>FM-M4</b> | + 204 € | Indoor glossy Metal M4<br>BLACK NICKEL <b>DZ</b> , CHAMPAGNE GOLD <b>DG</b> , GOLDEN BRONZE <b>DB</b> , MATT BLACK NICKEL <b>DY</b> , MATT GOLDEN BRONZE <b>DC</b> , PINK GOLD <b>DR</b>   |
| <b>ES-1</b>  | + 42 €  | Fireproof foam<br>ES-1   |
| <b>PD-F0</b> | + 6 €   | Felt pad feet<br>PD-F0   |

**Lea AP**

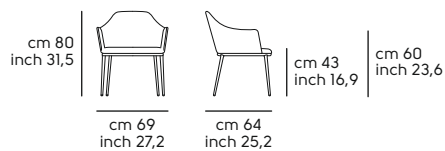



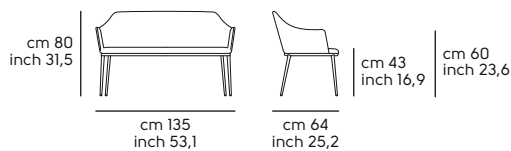





**Lea DV**



**Lea H65-H75-SG - Shell in hide, fabric or leather**

Frame in: metal

| Model  | Code    | Mod. | Frame | Shell | Optional | G.ty                            | boxes | Kg | M <sup>3</sup> |      |
|--|---------|------|-------|-------|----------|---------------------------------|-------|----|----------------|------|
|  |         |      |       | CU    | CT       |                                 |       |    |                |      |
| <b>Stool LEA H65 M CU</b><br> | S1940HC | H65  | MI    | 615 € | 835 €    | FM-M2<br>FM-M4<br>ES-1<br>PD-F0 | 1     | 1  | 9.5            | 0.34 |
| <b>Stool LEA H75 M CU</b><br> | S1940JC | H75  | MI    | 629 € | 850 €    | FM-M2<br>FM-M4<br>ES-1<br>PD-F0 | 1     | 1  | 10             | 0.38 |
| <b>Stool LEA SG CU</b><br>    | S1940ZC | SG   | MI    | 887 € | 1.114 €  | FM-M2<br>ES-1                   | 1     | 1  | 20.5           | 0.25 |

|   |         |     | TA | TB    | TC    | TD    | TE    | SF    | SV    | COM   | COL   |       |                                 |   |   |      |      |
|---|---------|-----|----|-------|-------|-------|-------|-------|-------|-------|-------|-------|---------------------------------|---|---|------|------|
| <b>Stool LEA H65 M TS</b>   |         |     |    |       |       |       |       |       |       |       |       |       |                                 |   |   |      |      |
|   | S1940HT | H65 | MI | 494 € | 525 € | 568 € | 603 € | 704 € | 607 € | 655 € | 503 € | 568 € | FM-M2<br>FM-M4<br>ES-1<br>PD-FO | 1 | 1 | 9.5  | 0.34 |
| <b>Stool LEA H75 M TS</b>   |         |     |    |       |       |       |       |       |       |       |       |       |                                 |   |   |      |      |
| <br> | S1940JT | H75 | MI | 497 € | 538 € | 580 € | 615 € | 717 € | 621 € | 670 € | 515 € | 580 € | FM-M2<br>FM-M4<br>ES-1<br>PD-FO | 1 | 1 | 10   | 0.38 |
| <b>Stool LEA SG TS</b>  |         |     |    |       |       |       |       |       |       |       |       |       |                                 |   |   |      |      |
| <br> | S1940ZT | SG  | MI | 764 € | 803 € | 846 € | 881 € | 982 € | 885 € | 933 € | 779 € | 846 € | FM-M2<br>ES-1                   | 1 | 1 | 19.5 | 0.25 |

**COM/COL - Minimum Q.ty 6 pc. for each material. For weft or patterned fabrics see specific pages**

|   |                        |  |               |
|---|------------------------|--|---------------|
|  <b>COM</b> | Mtl. 1.00 h. 1.40 Each |  <b>COL</b> | Mq. 1.60 Each |
|---|------------------------|--|---------------|

**Note:**

TS Front and Back covering available in two-tone or bi-material. Reference price in the upper category - Only Model M TS

**Frame finishes**

**Metal**

**MI** WHITE **BB**, BROWN **E6**, SAND **EC**, WHITE PEARL **EF**, GRAPHITE **EG**, BLACK **EN**

**Shell finishes**

**Upholstery**

|           |   |           |  |
|-----------|---|-----------|--|
| <b>TA</b> | FAUX LEATHER <b>Secret</b> , FABRIC <b>Mirage</b> , FABRIC <b>Cotton Club</b> , FABRIC <b>Renewed Loop</b>  | <b>TB</b> | FAUX LEATHER <b>Vintage</b> , FABRIC <b>Fenix Wool</b> , FABRIC <b>Visual</b> , FABRIC <b>Manhattan</b> , FABRIC <b>Novabuk</b> , FABRIC <b>Network</b> , FABRIC <b>Gyre</b> |
| <b>TC</b> | VELVET SUPERB, FABRIC <b>Second</b> , FABRIC <b>Main Line Flax</b> , FABRIC <b>Oceanic</b> , FABRIC <b>Jumper</b> , FABRIC <b>Flame</b> , FABRIC <b>Ouche</b> , FABRIC <b>Plain</b> , FABRIC <b>Gemma</b> , FABRIC <b>Caltagirone 114</b> | <b>TD</b> | FABRIC <b>Yoredale</b> , FABRIC <b>Remix 3</b>   |
| <b>TE</b> | FABRIC <b>Uniform Melange</b>   | <b>SF</b> | LEATHER <b>Fiore</b>   |
| <b>SV</b> | LEATHER <b>Vintage</b>  | <b>CU</b> | HIDE   |
| <b>CT</b> | TUSCAN HIDE   |           |  |

**Optionals:**

|              | Value   | Options/notes  |
|--------------|---------|--|
| <b>FM-M2</b> | + 54 €  | ASH GREY <b>ES</b> , BLUE SAPPHIRE <b>EE</b> , BLUE TURQUOISE <b>EH</b> , BRONZE <b>E2</b> , BULGARO RED <b>FP</b> , CHERRY RED <b>EQ</b> , DARK GREEN <b>EL</b> , FACEPOWDER PINK <b>E8</b> , FANGO <b>E3</b> , GOLDEN YELLOW <b>EO</b> , LIGHT BLUE <b>EO</b> , LIGHT GREY <b>ET</b> , OCEAN BLUE <b>EI</b> , OCHER YELLOW <b>E7</b> , PAPAYA ORANGE <b>EA</b> , PASTEL YELLOW <b>E4</b> , PINE GREEN <b>EJ</b> , RED <b>ER</b> , SAGE GREEN <b>E9</b> |
| <b>FM-M4</b> | + 162 € | BLACK NICKEL <b>DZ</b> , CHAMPAGNE GOLD <b>DG</b> , GOLDEN BRONZE <b>DB</b> , MATT BLACK NICKEL <b>DY</b> , MATT GOLDEN BRONZE <b>DC</b> , PINK GOLD <b>DR</b>   |
| <b>ES-1</b>  | + 21 €  | ES-1   |
| <b>PD-F0</b> | + 6 €   | PD-F0  |

**Lea H65**

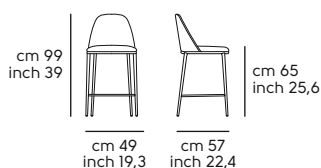

**Lea H75**

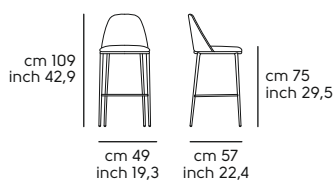

**Lea SG**

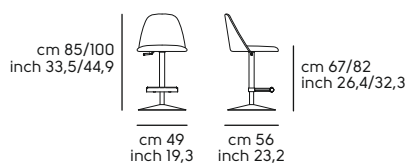

**Lea DELUXE S, P - Shell in fabric or leather**

Frame in: metal



| Model  | Code    | Mod. | Frame | Shell |       |       |       |       |       |       |       |       | Optional                        | Q.ty   | boxes  | Kg          | M²           |
|--|---------|------|-------|-------|-------|-------|-------|-------|-------|-------|-------|-------|---------------------------------|--------|--------|-------------|--------------|
|  |         |      |       | TA    | TB    | TC    | TD    | TE    | SF    | SV    | COM   | COL   |                                 |        |        |             |              |
| <br>Chair LEA DELUXE S M TS | S1943ST | S    | MI    | 440 € | 494 € | 536 € | 560 € | 671 € | 569 € | 610 € | 457 € | 536 € | FM-M2<br>FM-M4<br>ES-1<br>PD-F0 | 1<br>2 | 1<br>1 | 9.4<br>18.8 | 0.30<br>0.43 |

COM/COL - Minimum Q.ty 6 pc. for each material. For weft or patterned fabrics see specific pages

|  |   |
|--|---|
|  Mtl. 1.22 h. 1.40 Each |  Mq. 1.75 Each |
|--|---|

| Model   | Code    | Mod. | Frame | Shell |       |       |       |       |       |       |       |       | Optional                        | Q.ty | boxes | Kg | M²   |
|---|---------|------|-------|-------|-------|-------|-------|-------|-------|-------|-------|-------|---------------------------------|------|-------|----|------|
|   |         |      |       | TA    | TB    | TC    | TD    | TE    | SF    | SV    | COM   | COL   |                                 |      |       |    |      |
| <br>Armchair LEA DELUXE P M TS | S1943PT | P    | MI    | 557 € | 605 € | 658 € | 729 € | 891 € | 713 € | 828 € | 579 € | 658 € | FM-M2<br>FM-M4<br>ES-1<br>PD-F0 | 1    | 1     | 11 | 0.37 |

COM/COL - Minimum Q.ty 6 pc. for each material. For weft or patterned fabrics see specific pages

|  |   |
|--|---|
|  Mtl. 1.76 h. 1.40 Each |  Mq. 2.62 Each |
|--|---|

**Note:**

TS Front and Back covering available in two-tone or bi-material. Reference price in the upper category

**Frame finishes**

**Metal**

|           |   |
|-----------|---|
| <b>MI</b> | WHITE <b>BB</b> , BROWN <b>E6</b> , SAND <b>EC</b> , WHITE PEARL <b>EF</b> , GRAPHITE <b>EG</b> , BLACK <b>EN</b> |
|-----------|---|

**Shell finishes**

**Upholstery**

|           |   |           |  |
|-----------|---|-----------|--|
| <b>TA</b> | FAUX LEATHER <b>Secret</b> , FABRIC <b>Mirage</b> , FABRIC <b>Cotton Club</b> , FABRIC <b>Renewed Loop</b>  | <b>TB</b> | FAUX LEATHER <b>Vintage</b> , FABRIC <b>Fenix Wool</b> , FABRIC <b>Visual</b> , FABRIC <b>Manhattan</b> , FABRIC <b>Novabuk</b> , FABRIC <b>Network</b> , FABRIC <b>Gyre</b> |
| <b>TC</b> | VELVET SUPERB, FABRIC <b>Second</b> , FABRIC <b>Main Line Flax</b> , FABRIC <b>Oceanic</b> , FABRIC <b>Jumper</b> , FABRIC <b>Flame</b> , FABRIC <b>Ouche</b> , FABRIC <b>Plain</b> , FABRIC <b>Gemma</b> , FABRIC <b>Caltagirone 114</b> | <b>TD</b> | FABRIC <b>Yoredale</b> , FABRIC <b>Remix 3</b>   |
| <b>TE</b> | FABRIC <b>Uniform Melange</b>   | <b>SF</b> | LEATHER <b>Fiore</b>   |
| <b>SV</b> | LEATHER <b>Vintage</b>  |           |  |

**Optionals:**

|              | Value                             | Options/notes  |
|--------------|-----------------------------------|--|
| <b>FM-M2</b> | Indoor matt metal M2<br>+ 54 €    | ASH GREY <b>ES</b> , BLUE SAPPHIRE <b>EE</b> , BLUE TURQUOISE <b>EH</b> , BRONZE <b>E2</b> , BULGARO RED <b>FP</b> , CHERRY RED <b>EQ</b> , DARK GREEN <b>EL</b> , FACEPOWDER PINK <b>E8</b> , FANGO <b>E3</b> , GOLDEN YELLOW <b>EO</b> , LIGHT BLUE <b>EO</b> , LIGHT GREY <b>ET</b> , OCEAN BLUE <b>E1</b> , OCHER YELLOW <b>E7</b> , PAPAYA ORANGE <b>EA</b> , PASTEL YELLOW <b>E4</b> , PINE GREEN <b>EJ</b> , RED <b>ER</b> , SAGE GREEN <b>E9</b> |
| <b>FM-M4</b> | Indoor glossy Metal M4<br>+ 123 € | BLACK NICKEL <b>DZ</b> , CHAMPAGNE GOLD <b>DG</b> , GOLDEN BRONZE <b>DB</b> , MATT BLACK NICKEL <b>DY</b> , MATT GOLDEN BRONZE <b>DC</b> , PINK GOLD <b>DR</b>   |
| <b>ES-1</b>  | Fireproof foam<br>+ 21 €          | ES-1   |
| <b>PD-F0</b> | Felt pad feet<br>+ 6 €            | PD-F0  |

**Lea Deluxe S**

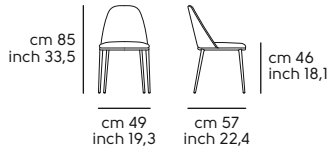

**Lea Deluxe P**

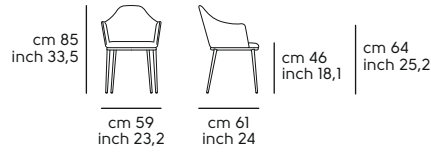



**Lea DELUXE S, P - Shell in fabric or leather**

Frame in: metal GX



| Model  | Code     | Mod. | Frame | Shell |       |       |       |       |       |       |       |       | Optional   | Q.ty | boxes | Kg   | M³   |
|--|----------|------|-------|-------|-------|-------|-------|-------|-------|-------|-------|-------|------------|------|-------|------|------|
|  |          |      |       | TA    | TB    | TC    | TD    | TE    | SF    | SV    | COM   | COL   |            |      |       |      |      |
| <br>Chair with self-return LEA DELUXE S GX T | S1943SYT | GX   | MI    | 670 € | 735 € | 776 € | 801 € | 911 € | 810 € | 852 € | 697 € | 776 € | FM-M2 ES-1 | 1    | 1     | 10.9 | 0.28 |

**COM/COL - Minimum Q.ty 6 pc. for each material. For weft or patterned fabrics see specific pages**

|   |   |
|---|---|
|  Mtl. 1.22 h. 1.40 Each |  Mq. 1.75 Each |
|---|---|

| Model   | Code     | Mod. | Frame | Shell |       |       |       |         |       |         |       |       | Optional   | Q.ty | boxes | Kg   | M³   |
|---|----------|------|-------|-------|-------|-------|-------|---------|-------|---------|-------|-------|------------|------|-------|------|------|
|   |          |      |       | TA    | TB    | TC    | TD    | TE      | SF    | SV      | COM   | COL   |            |      |       |      |      |
| <br>Armch. with self-return LEA DELUXE P GX | S1943PYT | GX   | MI    | 758 € | 847 € | 899 € | 969 € | 1.132 € | 955 € | 1.069 € | 787 € | 899 € | FM-M2 ES-1 | 1    | 1     | 13.2 | 0.35 |

**COM/COL - Minimum Q.ty 6 pc. for each material. For weft or patterned fabrics see specific pages**

|   |   |
|---|---|
|  Mtl. 1.76 h. 1.40 Each |  Mq. 2.62 Each |
|---|---|

**Note:**

TS Front and Back covering available in two-tone or bi-material. Reference price in the upper category

**Frame finishes**

**Metal**

|           |   |
|-----------|---|
| <b>MI</b> | WHITE <b>BB</b> , BROWN <b>E6</b> , SAND <b>EC</b> , WHITE PEARL <b>EF</b> , GRAPHITE <b>EG</b> , BLACK <b>EN</b> |
|-----------|---|

**Shell finishes**

**Upholstery**

|           |   |           |  |
|-----------|---|-----------|--|
| <b>TA</b> | FAUX LEATHER <b>Secret</b> , FABRIC <b>Mirage</b> , FABRIC <b>Cotton Club</b> , FABRIC <b>Renewed Loop</b>  | <b>TB</b> | FAUX LEATHER <b>Vintage</b> , FABRIC <b>Fenix Wool</b> , FABRIC <b>Visual</b> , FABRIC <b>Manhattan</b> , FABRIC <b>Novabuk</b> , FABRIC <b>Network</b> , FABRIC <b>Gyre</b> |
| <b>TC</b> | VELVET SUPERB, FABRIC <b>Second</b> , FABRIC <b>Main Line Flax</b> , FABRIC <b>Oceanic</b> , FABRIC <b>Jumper</b> , FABRIC <b>Flame</b> , FABRIC <b>Ouche</b> , FABRIC <b>Plain</b> , FABRIC <b>Gemma</b> , FABRIC <b>Caltagirone 114</b> | <b>TD</b> | FABRIC <b>Yoredale</b> , FABRIC <b>Remix 3</b>   |
| <b>TE</b> | FABRIC <b>Uniform Melange</b>   | <b>SF</b> | LEATHER <b>Fiore</b>   |
| <b>SV</b> | LEATHER <b>Vintage</b>  |           |  |

**Options:**

|              | Value  | Options/notes  |
|--------------|--------|--|
| <b>FM-M2</b> | + 54 € | ASH GREY <b>ES</b> , BLUE SAPPHIRE <b>EE</b> , BLUE TURQUOISE <b>EH</b> , BRONZE <b>E2</b> , BULGARO RED <b>FP</b> , CHERRY RED <b>EQ</b> , DARK GREEN <b>EL</b> , FACEPOWDER PINK <b>E8</b> , FANGO <b>E3</b> , GOLDEN YELLOW <b>EO</b> , LIGHT BLUE <b>EO</b> , LIGHT GREY <b>ET</b> , OCEAN BLUE <b>EI</b> , OCHER YELLOW <b>E7</b> , PAPAYA ORANGE <b>EA</b> , PASTEL YELLOW <b>E4</b> , PINE GREEN <b>EJ</b> , RED <b>ER</b> , SAGE GREEN <b>E9</b> |
| <b>ES-1</b>  | + 21 € | ES-1   |

**Lea Deluxe S GX**

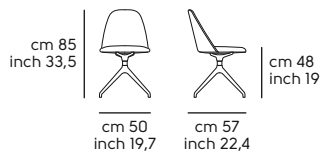

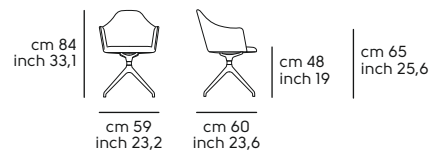

**Lea Deluxe P GX**





**Lea DELUXE H65-H75-SG - Shell in fabric or leather**

Frame in: metal

| Model   | Code    | Mod. | Frame | Shell |       |       |       |         |       |       |       | Optional | Q.ty                            | boxes | Kg | M³   |      |
|---|---------|------|-------|-------|-------|-------|-------|---------|-------|-------|-------|----------|---------------------------------|-------|----|------|------|
|   |         |      |       | TA    | TB    | TC    | TD    | TE      | SF    | SV    | COM   |          |                                 |       |    |      | COL  |
| <b>Stool LEA DELUXE H65 M TS</b><br> | S1943HT | H65  | M1    | 526 € | 564 € | 606 € | 641 € | 742 €   | 646 € | 693 € | 547 € | 606 €    | FM-M2<br>FM-M4<br>ES-1<br>PD-F0 | 1     | 1  | 9.5  | 0.35 |
| <b>Stool LEA DELUXE H75 M TS</b><br> | S1943JT | H75  | M1    | 537 € | 574 € | 617 € | 652 € | 752 €   | 656 € | 703 € | 558 € | 617 €    | FM-M2<br>FM-M4<br>ES-1<br>PD-F0 | 1     | 1  | 10   | 0.37 |
| <b>Stool LEA DELUXE SG TS</b><br>    | S1943ZT | SG   | M1    | 792 € | 838 € | 881 € | 916 € | 1.017 € | 920 € | 967 € | 823 € | 881 €    | FM-M2<br>ES-1                   | 1     | 1  | 19.5 | 0.35 |

**COM/COL - Minimum Q.ty 6 pc. for each material. For weft or patterned fabrics see specific pages**

|   |   |
|---|---|
| <p><b>COM</b><br/> Mtl. 1.18 h. 1.40 Each</p> | <p><b>COL</b><br/> Mq. 1.65 Each</p> |
|---|---|

**Note:**  
TS Front and Back covering available in two-tone or bi-material. Reference price in the upper category

**Frame finishes**

**Metal**

|           |   |
|-----------|---|
| <b>MI</b> | WHITE <b>BB</b> , BROWN <b>E6</b> , SAND <b>EC</b> , WHITE PEARL <b>EF</b> , GRAPHITE <b>EG</b> , BLACK <b>EN</b> |
|-----------|---|

**Shell finishes**

**Upholstery**

|           |   |           |  |
|-----------|---|-----------|--|
| <b>TA</b> | FAUX LEATHER <b>Secret</b> , FABRIC <b>Mirage</b> , FABRIC <b>Cotton Club</b> , FABRIC <b>Renewed Loop</b>  | <b>TB</b> | FAUX LEATHER <b>Vintage</b> , FABRIC <b>Fenix Wool</b> , FABRIC <b>Visual</b> , FABRIC <b>Manhattan</b> , FABRIC <b>Novabuk</b> , FABRIC <b>Network</b> , FABRIC <b>Gyre</b> |
| <b>TC</b> | VELVET SUPERB, FABRIC <b>Second</b> , FABRIC <b>Main Line Flax</b> , FABRIC <b>Oceanic</b> , FABRIC <b>Jumper</b> , FABRIC <b>Flame</b> , FABRIC <b>Ouche</b> , FABRIC <b>Plain</b> , FABRIC <b>Gemma</b> , FABRIC <b>Caltagirone 114</b> | <b>TD</b> | FABRIC <b>Yoredale</b> , FABRIC <b>Remix 3</b>   |
| <b>TE</b> | FABRIC <b>Uniform Melange</b>   | <b>SF</b> | LEATHER <b>Fiore</b>   |
| <b>SV</b> | LEATHER <b>Vintage</b>  |           |  |

**Optionals:**

|              | Value                  | Options/notes |  |
|--------------|------------------------|---------------|--|
| <b>FM-M2</b> | Indoor matt metal M2   | + 54 €        | ASH GREY <b>ES</b> , BLUE SAPPHIRE <b>EE</b> , BLUE TURQUOISE <b>EH</b> , BRONZE <b>E2</b> , BULGARO RED <b>FP</b> , CHERRY RED <b>EQ</b> , DARK GREEN <b>EL</b> , FACEPOWDER PINK <b>E8</b> , FANGO <b>E3</b> , GOLDEN YELLOW <b>EO</b> , LIGHT BLUE <b>EO</b> , LIGHT GREY <b>ET</b> , OCEAN BLUE <b>E1</b> , OCHER YELLOW <b>E7</b> , PAPAYA ORANGE <b>EA</b> , PASTEL YELLOW <b>E4</b> , PINE GREEN <b>EJ</b> , RED <b>ER</b> , SAGE GREEN <b>E9</b> |
| <b>FM-M4</b> | Indoor glossy Metal M4 | + 162 €       | BLACK NICKEL <b>DZ</b> , CHAMPAGNE GOLD <b>DG</b> , GOLDEN BRONZE <b>DB</b> , MATT BLACK NICKEL <b>DY</b> , MATT GOLDEN BRONZE <b>DC</b> , PINK GOLD <b>DR</b>   |
| <b>ES-1</b>  | Fireproof foam         | + 21 €        | ES-1   |
| <b>PD-F0</b> | Felt pad feet          | + 6 €         | PD-F0  |

**Lea Deluxe H65**

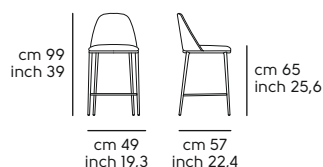

**Lea Deluxe H75**

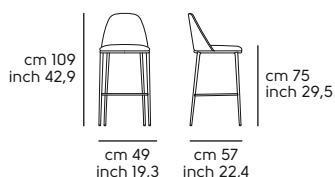

**Lea Deluxe SG**

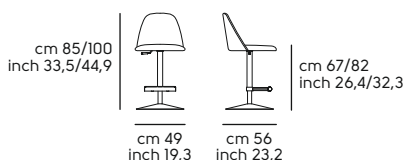

**Lea B1-B2-B3 pouf - Seat in fabric or leather**

Frame in: metal

| Model  | Code    | Mod. | Frame | Shell |       |       |       |       |       |       |       |       | Optional                        | Q.ty | boxes | Kg  | M³   |
|--|---------|------|-------|-------|-------|-------|-------|-------|-------|-------|-------|-------|---------------------------------|------|-------|-----|------|
|  |         |      |       | TA    | TB    | TC    | TD    | TE    | SF    | SV    | COM   | COL   |                                 |      |       |     |      |
|  <p><b>Pouf LEA B1 M TS</b></p> | S1940B1 | B1   | M1    | 248 € | 262 € | 266 € | 313 € | 380 € | 276 € | 302 € | 253 € | 266 € | FM-M2<br>FM-M4<br>ES-1<br>PD-F0 | 1    | 1     | 5.5 | 0.10 |
|  |         |      |       |       |       |       |       |       |       |       |       |       |                                 |      |       |     |      |

COM/COL - Minimum Q.ty 6 pc. for each material. For weft or patterned fabrics see specific pages

|  |   |
|--|---|
|  Mtl. 0.35 h. 1.40 Each |  Mq. 1.15 Each |
|--|---|



| Model  | Code    | Mod. | Frame | Shell |       |       |       |       |       |       |       |       | Optional                        | Q.ty | boxes | Kg  | M³   |
|--|---------|------|-------|-------|-------|-------|-------|-------|-------|-------|-------|-------|---------------------------------|------|-------|-----|------|
|  |         |      |       | TA    | TB    | TC    | TD    | TE    | SF    | SV    | COM   | COL   |                                 |      |       |     |      |
|  <p><b>Pouf LEA B2 M TS</b></p> | S1940B2 | B2   | M1    | 277 € | 295 € | 302 € | 358 € | 438 € | 315 € | 356 € | 282 € | 302 € | FM-M2<br>FM-M4<br>ES-1<br>PD-F0 | 1    | 1     | 5.8 | 0.11 |
|  |         |      |       |       |       |       |       |       |       |       |       |       |                                 |      |       |     |      |

COM/COL - Minimum Q.ty 6 pc. for each material. For weft or patterned fabrics see specific pages

|  |   |
|--|---|
|  Mtl. 0.40 h. 1.40 Each |  Mq. 1.40 Each |
|--|---|

| Model  | Code    | Mod. | Frame | Shell |       |       |       |       |       |       |       |       | Optional                        | Q.ty | boxes | Kg  | M³   |
|--|---------|------|-------|-------|-------|-------|-------|-------|-------|-------|-------|-------|---------------------------------|------|-------|-----|------|
|  |         |      |       | TA    | TB    | TC    | TD    | TE    | SF    | SV    | COM   | COL   |                                 |      |       |     |      |
|  <p><b>Pouf LEA B3 M TS</b></p> | S1940B3 | B3   | M1    | 335 € | 368 € | 393 € | 454 € | 575 € | 428 € | 503 € | 342 € | 393 € | FM-M2<br>FM-M4<br>ES-1<br>PD-F0 | 1    | 1     | 7.1 | 0.16 |
|  |         |      |       |       |       |       |       |       |       |       |       |       |                                 |      |       |     |      |

COM/COL - Minimum Q.ty 6 pc. for each material. For weft or patterned fabrics see specific pages

|  |   |
|--|---|
|  Mtl. 0.60 h. 1.40 Each |  Mq. 2.20 Each |
|--|---|

**Frame finishes**

|              |   |
|--------------|---|
| <b>Metal</b> |   |
| <b>MI</b>    | WHITE <b>BB</b> , BROWN <b>E6</b> , SAND <b>EC</b> , WHITE PEARL <b>EF</b> , GRAPHITE <b>EG</b> , BLACK <b>EN</b> |

**Shell finishes**

|                   |   |           |  |
|-------------------|---|-----------|--|
| <b>Upholstery</b> |   |           |  |
| <b>TA</b>         | FAUX LEATHER <b>Secret</b> , FABRIC <b>Mirage</b> , FABRIC <b>Cotton Club</b> , FABRIC <b>Renewed Loop</b>  | <b>TB</b> | FAUX LEATHER <b>Vintage</b> , FABRIC <b>Fenix Wool</b> , FABRIC <b>Visual</b> , FABRIC <b>Manhattan</b> , FABRIC <b>Novabuk</b> , FABRIC <b>Network</b> , FABRIC <b>Gyre</b> |
| <b>TC</b>         | VELVET SUPERB, FABRIC <b>Second</b> , FABRIC <b>Main Line Flax</b> , FABRIC <b>Oceanic</b> , FABRIC <b>Jumper</b> , FABRIC <b>Flame</b> , FABRIC <b>Ouche</b> , FABRIC <b>Plain</b> , FABRIC <b>Gemma</b> , FABRIC <b>Caltagirone 114</b> | <b>TD</b> | FABRIC <b>Yoredale</b> , FABRIC <b>Remix 3</b>   |
| <b>TE</b>         | FABRIC <b>Uniform Melange</b>   | <b>SF</b> | LEATHER <b>Fiore</b>   |
| <b>SV</b>         | LEATHER <b>Vintage</b>  |           |  |

**Optionals:**

|              |                        | Value   | Options/notes  |
|--------------|------------------------|---------|--|
| <b>FM-M2</b> | Indoor matt metal M2   | + 48 €  | ASH GREY <b>ES</b> , BLUE SAPPHIRE <b>EE</b> , BLUE TURQUOISE <b>EH</b> , BRONZE <b>E2</b> , BULGARO RED <b>FP</b> , CHERRY RED <b>EQ</b> , DARK GREEN <b>EL</b> , FACEPOWDER PINK <b>E8</b> , FANGO <b>E3</b> , GOLDEN YELLOW <b>EO</b> , LIGHT BLUE <b>EO</b> , LIGHT GREY <b>ET</b> , OCEAN BLUE <b>E1</b> , OCHER YELLOW <b>E7</b> , PAPAYA ORANGE <b>EA</b> , PASTEL YELLOW <b>E4</b> , PINE GREEN <b>EJ</b> , RED <b>ER</b> , SAGE GREEN <b>E9</b> |
| <b>FM-M4</b> | Indoor glossy Metal M4 | + 123 € | BLACK NICKEL <b>DZ</b> , CHAMPAGNE GOLD <b>DG</b> , GOLDEN BRONZE <b>DB</b> , MATT BLACK NICKEL <b>DY</b> , MATT GOLDEN BRONZE <b>DC</b> , PINK GOLD <b>DR</b>   |
| <b>ES-1</b>  | Fireproof foam         | + 5 €   | ES-1   |
| <b>PD-F0</b> | Felt pad feet          | + 6 €   | PD-F0  |

**Lea B1**

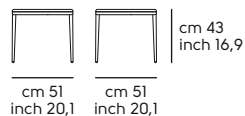

**Lea B2**

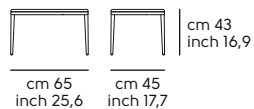

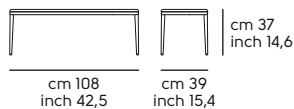

**Lea B3**



# Less design Roberto Paoli

## Less H45, H65, H75 - Seat in wood, fabric or leather

Frame in: metal

| Model  | Code    | Mod. | Frame | Seat  | Optional       | G.ty | boxes | Kg | M <sup>3</sup> |
|--|---------|------|-------|-------|----------------|------|-------|----|----------------|
|  |         |      |       | LF1   |                |      |       |    |                |
| <b>Stool LESS H45 M LG</b>   |         |      |       |       |                |      |       |    |                |
|   | S2340SL | H45  | M1    | 299 € | FM-M2<br>PD-F0 | 2    | 1     | 14 | 0.16           |
| <b>Stool LESS H65 M LG</b>   |         |      |       |       |                |      |       |    |                |
|   | S2340HL | H65  | M1    | 328 € | FM-M2<br>PD-F0 | 2    | 1     | 16 | 0.22           |
| <b>Stool LESS H75 M LG</b>   |         |      |       |       |                |      |       |    |                |
|  | S2340JL | H75  | M1    | 338 € | FM-M2<br>PD-F0 | 2    | 1     | 17 | 0.27           |

### Frame finishes

#### Metal

|           |  |
|-----------|--|
| <b>M1</b> | 2Str BROWN <b>E6</b> , 2Str WHITE <b>BB</b> , 2Str SAND <b>EC</b> , 2Str GRAPHITE <b>EG</b> , 2Str BLACK <b>EN</b> |
|-----------|--|



### Seat finishes

#### Wood



|            |  |
|------------|--|
| <b>LF1</b> | Ash wood stained BLACK <b>F04</b> , Ash wood stained WHITE <b>F05</b> , Ash wood stained CHERRY RED <b>F09</b> , Ash wood stained FLAMED WALNUT <b>F24</b> , Ash wood stained DARK BROWN <b>F26</b> , Ash wood stained NATURAL <b>F40</b> , Ash wood stained NATURAL OAK <b>F52</b> , Ash wood stained WHITENED <b>F60</b> , Ash wood stained DESERT <b>F61</b> , Ash wood stained LIGHT GREY <b>F62</b> , Ash wood stained DARK GREY <b>F63</b> |
|------------|--|

### Optionals:

|              |                      | Value  | Options/notes  |
|--------------|----------------------|--------|--|
| <b>FM-M2</b> | Indoor matt metal M2 | + 42 € | 2Str ASH GREY <b>ES</b> , 2Str BLUE SAPPHIRE <b>EE</b> , 2Str BLUE TURQUOISE <b>EH</b> , 2Str BRONZE <b>E2</b> , 2Str BULGARO RED <b>FP</b> , 2Str CHERRY RED <b>EQ</b> , 2Str DARK GREEN <b>EL</b> , 2Str FACEPOWDER PINK <b>E8</b> , 2Str FANGO <b>E3</b> , 2Str GOLDEN YELLOW <b>EO</b> , 2Str LIGHT BLUE <b>EO</b> , 2Str LIGHT GREY <b>ET</b> , 2Str OCEAN BLUE <b>E1</b> , 2Str OCHER YELLOW <b>E7</b> , 2Str PAPAYA ORANGE <b>EA</b> , 2Str PASTEL YELLOW <b>E4</b> , 2Str PINE GREEN <b>EJ</b> , 2Str RED <b>ER</b> , 2Str SAGE GREEN <b>E9</b> , 2Str WHITE PEARL <b>EF</b> |
| <b>PD-F0</b> | Felt pad feet        | + 6 €  | PD-F0  |

| Model  | Code    | Mod. | Frame | Seat  |       |       |       |       |       |       |       |       | Optional               | Q.ty | boxes | Kg | M³   |
|--|---------|------|-------|-------|-------|-------|-------|-------|-------|-------|-------|-------|------------------------|------|-------|----|------|
|  |         |      |       | TA    | TB    | TC    | TD    | TE    | SF    | SV    | COM   | COL   |                        |      |       |    |      |
| <br><b>Stool LESS H45 M TS</b> | S2340ST | H45  | M1    | 296 € | 306 € | 308 € | 310 € | 328 € | 321 € | 328 € | 296 € | 308 € | FM-M2<br>ES-1<br>PD-FO | 2    | 1     | 13 | 0.16 |
| <br><b>Stool LESS H65 M TS</b> | S2340HT | H65  | M1    | 311 € | 321 € | 323 € | 326 € | 343 € | 337 € | 343 € | 311 € | 323 € | FM-M2<br>ES-1<br>PD-FO | 2    | 1     | 16 | 0.22 |
| <br><b>Stool LESS H75 M TS</b> | S2340JT | H75  | M1    | 328 € | 332 € | 334 € | 336 € | 354 € | 347 € | 354 € | 328 € | 334 € | FM-M2<br>ES-1<br>PD-FO | 2    | 1     | 17 | 0.27 |

**COM/COL - Minimum Q.ty 6 pc. for each material. For weft or patterned fabrics see specific pages**

|   |                        |  |               |
|---|------------------------|--|---------------|
|  <b>COM</b> | Mtl. 0.20 h. 1.40 Each |  <b>COL</b> | Mq. 0.30 Each |
|---|------------------------|--|---------------|

**Frame finishes**

**Metal**

|           |  |
|-----------|--|
| <b>M1</b> | 2Str BROWN <b>E6</b> , 2Str WHITE <b>BB</b> , 2Str SAND <b>EC</b> , 2Str GRAPHITE <b>EG</b> , 2Str BLACK <b>EN</b> |
|-----------|--|

**Seat finishes**

**Upholstery**

|           |   |           |  |
|-----------|---|-----------|--|
| <b>TA</b> | FAUX LEATHER <b>Secret</b> , FABRIC <b>Mirage</b> , FABRIC <b>Cotton Club</b> , FABRIC <b>Renewed Loop</b>  | <b>TB</b> | FAUX LEATHER <b>Vintage</b> , FABRIC <b>Fenix Wool</b> , FABRIC <b>Visual</b> , FABRIC <b>Manhattan</b> , FABRIC <b>Novabuk</b> , FABRIC <b>Network</b> , FABRIC <b>Gyre</b> |
| <b>TC</b> | VELVET SUPERB, FABRIC <b>Second</b> , FABRIC <b>Main Line Flax</b> , FABRIC <b>Oceanic</b> , FABRIC <b>Jumper</b> , FABRIC <b>Flame</b> , FABRIC <b>Ouche</b> , FABRIC <b>Plain</b> , FABRIC <b>Gemma</b> , FABRIC <b>Caltagirone 114</b> | <b>TD</b> | FABRIC <b>Yoredale</b> , FABRIC <b>Remix 3</b>   |
| <b>TE</b> | FABRIC <b>Uniform Melange</b>   | <b>SF</b> | LEATHER <b>Fiore</b>   |
| <b>SV</b> | LEATHER <b>Vintage</b>  |           |  |

**Optionals:**

|              | Value  | Options/notes   |
|--------------|--------|---|
| <b>FM-M2</b> | + 42 € | 2Str ASH GREY <b>ES</b> , 2Str BLUE SAPPHIRE <b>EE</b> , 2Str BLUE TURQUOISE <b>EH</b> , 2Str BRONZE <b>E2</b> , 2Str BULGARRO RED <b>FP</b> , 2Str CHERRY RED <b>EQ</b> , 2Str DARK GREEN <b>EL</b> , 2Str FACEPOWDER PINK <b>E8</b> , 2Str FANGO <b>E3</b> , 2Str GOLDEN YELLOW <b>EO</b> , 2Str LIGHT BLUE <b>E0</b> , 2Str LIGHT GREY <b>ET</b> , 2Str OCEAN BLUE <b>E1</b> , 2Str OCHER YELLOW <b>E7</b> , 2Str PAPAYA ORANGE <b>EA</b> , 2Str PASTEL YELLOW <b>E4</b> , 2Str PINE GREEN <b>EJ</b> , 2Str RED <b>ER</b> , 2Str SAGE GREEN <b>E9</b> , 2Str WHITE PEARL <b>EF</b> |
| <b>ES-1</b>  | + 5 €  | ES-1  |
| <b>PD-FO</b> | + 6 €  | PD-FO   |

**Less H45 TS**

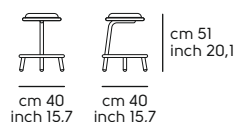

**Less H65 TS**

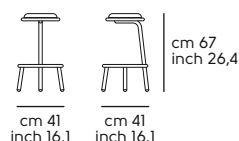

**Less H75 TS**

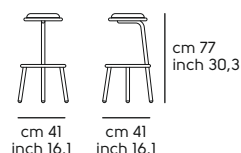

**Less H45 LG**

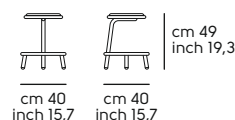

**Less H65 LG**

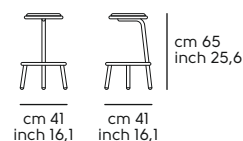



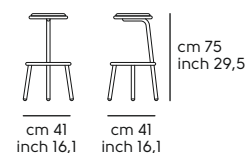





**Less H75 LG**



# Liù design Archirivolto

## Liù S, P, D, DP - Wood shell

Frame in: metal or wood or metal-wood

| Model  | Code      | Base type | Frame  | Shell |       | Optional                         | G.ty   | boxes  | Kg         | M³           |
|--|-----------|-----------|--------|-------|-------|----------------------------------|--------|--------|------------|--------------|
|  |           |           |        | L11   | L12   |                                  |        |        |            |              |
| <b>Chair LIÙ S M LG_M</b><br>       | S1280SL_M | _M        | M1     | 269 € | 291 € | FM-M2<br>FM-M3<br>FM-M4<br>PD-F0 | 2<br>4 | 1<br>1 | 12<br>25.0 | 0.34<br>0.43 |
| <b>Chair LIÙ S M LG_T</b><br>       | S1280SL_T | _T        | M1     | 293 € | 315 € | FM-M2<br>FM-M3<br>FM-M4          | 2<br>4 | 1<br>1 | 12<br>25.0 | 0.34<br>0.43 |
| <b>Chair LIÙ S M LG_X</b><br>      | S1280SL_X | _X        | M1     | 290 € | 312 € | FM-M2<br>FM-M3<br>FM-M4<br>PD-F0 | 2      | 1      | 12         | 0.28         |
| <b>Chair LIÙ S L LG_R</b><br>     | S1280WL_R | _R        | LF1    | 364 € | 386 € | PD-F0                            | 2      | 1      | 19         | 0.31         |
| <b>Chair LIÙ S ML LG</b><br>      | S1285ML   | ML        | LF1-M1 | 390 € | 412 € | FM-M2<br>PD-F0                   | 2      | 1      | 20         | 0.32         |
| <b>Armchair LIÙ P M LG</b><br>    | S1280PL   | M         | M1     | 318 € | 341 € | FM-M2<br>FM-M3<br>FM-M4<br>PD-F0 | 2<br>4 | 1<br>1 | 14<br>31.0 | 0.36<br>0.51 |
| <b>Office Chair LIÙ DS LG</b><br> | S1280DL   | DS        | M1     | 456 € | 477 € | FM-M2<br>FM-M3                   | 1      | 2      | 10.5       | 0.27         |
| <b>Office Arm. LIÙ DP LG</b><br>  | S1280EL   | DP        | M1     | 504 € | 525 € | FM-M2<br>FM-M3                   | 1      | 2      | 11         | 0.34         |

**Frame finishes**

| Metal     |   |
|-----------|---|
| <b>MI</b> | WHITE <b>BB</b> , BROWN <b>E6</b> , SAND <b>EC</b> , WHITE PEARL <b>EF</b> , GRAPHITE <b>EG</b> , BLACK <b>EN</b> |

| Wood       |  |
|------------|--|
| <b>LFI</b> | Ash wood stained BLACK <b>F04</b> , Ash wood stained WHITE <b>F05</b> , Ash wood stained CHERRY RED <b>F09</b> , Ash wood stained FLAMED WALNUT <b>F24</b> , Ash wood stained DARK BROWN <b>F26</b> , Ash wood stained NATURAL <b>F40</b> , Ash wood stained NATURAL OAK <b>F52</b> , Ash wood stained WHITENED <b>F60</b> , Ash wood stained DESERT <b>F61</b> , Ash wood stained LIGHT GREY <b>F62</b> , Ash wood stained DARK GREY <b>F63</b> |

**Insert finishes**

| Metal     |   |
|-----------|---|
| <b>MI</b> | WHITE <b>BB</b> , BROWN <b>E6</b> , SAND <b>EC</b> , WHITE PEARL <b>EF</b> , GRAPHITE <b>EG</b> , BLACK <b>EN</b> |

**Shell finishes**

| Wood        |  |
|-------------|--|
| <b>LII</b>  | Veneered wood painted BLACK <b>I04</b> , Veneered wood painted WHITE <b>I05</b> , Veneered wood painted CHERRY RED <b>I09</b> , Veneered wood painted DARK BROWN <b>I26</b> , Veneered wood painted NATURAL <b>I40</b> , Veneered wood painted NATURAL OAK <b>I52</b> , Veneered wood painted WHITENED <b>I60</b> , Veneered wood painted DESERT <b>I61</b> , Veneered wood painted LIGHT GREY <b>I62</b> , Veneered wood painted DARK GREY <b>I63</b> |
| <b>LII2</b> | Veneered wood NATURAL OAK <b>I22</b> , Veneered wood FLAMED WALNUT <b>I24</b>  |

**Optionals:**

|              |                        | Value   | Options/notes  |
|--------------|------------------------|---------|--|
| <b>FM-M2</b> | Indoor matt metal M2   | + 48 €  | ASH GREY <b>ES</b> , BLUE SAPPHIRE <b>EE</b> , BLUE TURQUOISE <b>EH</b> , BRONZE <b>E2</b> , BULGARO RED <b>FP</b> , CHERRY RED <b>EQ</b> , DARK GREEN <b>EL</b> , FACEPOWDER PINK <b>E8</b> , FANGO <b>E3</b> , GOLDEN YELLOW <b>EO</b> , LIGHT BLUE <b>EO</b> , LIGHT GREY <b>ET</b> , OCEAN BLUE <b>E1</b> , OCHER YELLOW <b>E7</b> , PAPAYA ORANGE <b>EA</b> , PASTEL YELLOW <b>E4</b> , PINE GREEN <b>EJ</b> , RED <b>ER</b> , SAGE GREEN <b>E9</b> |
| <b>FM-M3</b> | Indoor glossy metal M3 | + 48 €  | CHROME <b>CC</b>   |
| <b>FM-M4</b> | Indoor glossy Metal M4 | + 108 € | BLACK NICKEL <b>DZ</b> , CHAMPAGNE GOLD <b>DG</b> , GOLDEN BRONZE <b>DB</b> , MATT BLACK NICKEL <b>DY</b> , MATT GOLDEN BRONZE <b>DC</b> , PINK GOLD <b>DR</b>   |
| <b>PD-F0</b> | Felt pad feet          | + 6 €   | PD-F0  |

**Liù S\_M**

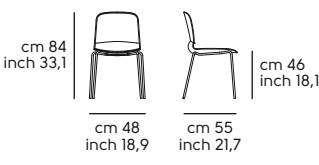

**Liù S\_T**

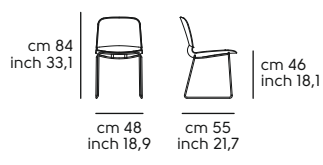

**Liù S\_X**

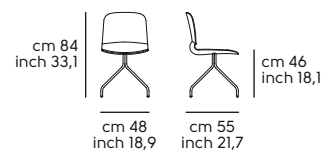

**Liù S\_R**

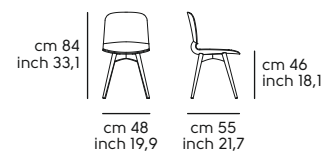

**Liù S ML**

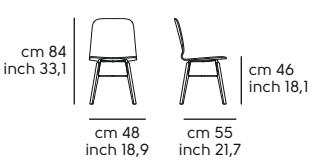

**Liù P M**

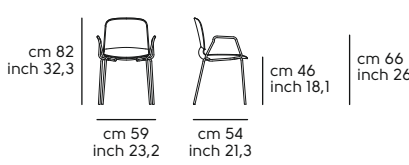

**Liù S DS**

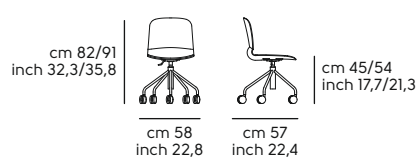



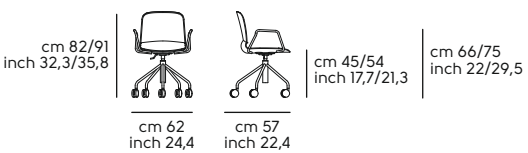





**Liù P DP**



**LIÙ S, P, D, DP - Shell in fabric or leather with horizontal stitches**

Frame in: metal or wood or metal-wood

| Model  | Code      | Base type | Frame  | Shell |       |       |       |       |       |       |       |       | Optional                                 | Q.ty   | boxes  | Kg         | M <sup>3</sup> |
|--|-----------|-----------|--------|-------|-------|-------|-------|-------|-------|-------|-------|-------|--|--------|--------|------------|----------------|
|  |           |           |        | TA    | TB    | TC    | TD    | TE    | SF    | SV    | COM   | COL   |  |        |        |            |                |
| <b>Chair LIÙ S M TS_M</b><br>       | S1280ST_M | _M        | M1     | 276 € | 288 € | 331 € | 357 € | 446 € | 366 € | 438 € | 276 € | 331 € | FM-M2<br>FM-M3<br>FM-M4<br>ES-1<br>PD-F0 | 2<br>4 | 1<br>1 | 16<br>24.0 | 0.34<br>0.46   |
| <b>Chair LIÙ S M TS_T</b><br>       | S1280ST_T | _T        | M1     | 300 € | 312 € | 355 € | 381 € | 470 € | 390 € | 462 € | 300 € | 355 € | FM-M2<br>FM-M3<br>FM-M4<br>ES-1          | 2<br>4 | 1<br>1 | 16<br>24.0 | 0.34<br>0.46   |
| <b>Chair LIÙ S M TS_X</b><br>       | S1280ST_X | _X        | M1     | 297 € | 309 € | 352 € | 378 € | 467 € | 387 € | 459 € | 297 € | 352 € | FM-M2<br>FM-M3<br>FM-M4<br>ES-1<br>PD-F0 | 2      | 1      | 16         | 0.34           |
| <b>Chair LIÙ S L TS_R</b><br>      | S1280WT_R | _R        | LF1    | 372 € | 384 € | 426 € | 456 € | 545 € | 461 € | 534 € | 372 € | 426 € | ES-1<br>PD-F0                            | 2      | 1      | 14         | 0.35           |
| <b>Chair LIÙ S ML TS</b><br>      | S1285MT   | ML        | LF1-M1 | 396 € | 410 € | 454 € | 478 € | 568 € | 488 € | 560 € | 396 € | 454 € | FM-M2<br>ES-1<br>PD-F0                   | 2      | 1      | 12         | 0.28           |
| <b>Armchair LIÙ P M TS</b><br>    | S1280PT   | M         | M1     | 323 € | 336 € | 381 € | 406 € | 494 € | 414 € | 488 € | 323 € | 381 € | FM-M2<br>FM-M3<br>FM-M4<br>ES-1<br>PD-F0 | 2<br>4 | 1<br>1 | 14<br>31.0 | 0.36<br>0.51   |
| <b>Office Chair LIÙ DS TS</b><br> | S1280DT   | DS        | M1     | 462 € | 473 € | 516 € | 545 € | 632 € | 550 € | 623 € | 462 € | 516 € | FM-M2<br>FM-M3<br>ES-1                   | 1      | 2      | 10.5       | 0.28           |
| <b>Office Arm. LIÙ DP TS</b><br>  | S1280ET   | DP        | M1     | 512 € | 522 € | 566 € | 594 € | 683 € | 599 € | 673 € | 512 € | 566 € | FM-M2<br>FM-M3<br>ES-1                   | 1      | 2      | 11         | 0.35           |

**Frame finishes**

**Metal**

|           |   |
|-----------|---|
| <b>MI</b> | WHITE <b>BB</b> , BROWN <b>E6</b> , SAND <b>EC</b> , WHITE PEARL <b>EF</b> , GRAPHITE <b>EG</b> , BLACK <b>EN</b> |
|-----------|---|

**Wood**

|            |  |
|------------|--|
| <b>LFI</b> | Ash wood stained BLACK <b>F04</b> , Ash wood stained WHITE <b>F05</b> , Ash wood stained CHERRY RED <b>F09</b> , Ash wood stained FLAMED WALNUT <b>F24</b> , Ash wood stained DARK BROWN <b>F26</b> , Ash wood stained NATURAL <b>F40</b> , Ash wood stained NATURAL OAK <b>F52</b> , Ash wood stained WHITENED <b>F60</b> , Ash wood stained DESERT <b>F61</b> , Ash wood stained LIGHT GREY <b>F62</b> , Ash wood stained DARK GREY <b>F63</b> |
|------------|--|

**Insert finishes**

**Metal**

|           |   |
|-----------|---|
| <b>MI</b> | WHITE <b>BB</b> , BROWN <b>E6</b> , SAND <b>EC</b> , WHITE PEARL <b>EF</b> , GRAPHITE <b>EG</b> , BLACK <b>EN</b> |
|-----------|---|

**Shell finishes**

**Upholstery**

|           |   |           |  |
|-----------|---|-----------|--|
| <b>TA</b> | FAUX LEATHER <b>Secret</b> , FABRIC <b>Mirage</b> , FABRIC <b>Cotton Club</b> , FABRIC <b>Renewed Loop</b>  | <b>TB</b> | FAUX LEATHER <b>Vintage</b> , FABRIC <b>Fenix Wool</b> , FABRIC <b>Visual</b> , FABRIC <b>Manhattan</b> , FABRIC <b>Novabuk</b> , FABRIC <b>Network</b> , FABRIC <b>Gyre</b> |
| <b>TC</b> | VELVET SUPERB, FABRIC <b>Second</b> , FABRIC <b>Main Line Flax</b> , FABRIC <b>Oceanic</b> , FABRIC <b>Jumper</b> , FABRIC <b>Flame</b> , FABRIC <b>Ouche</b> , FABRIC <b>Plain</b> , FABRIC <b>Gemma</b> , FABRIC <b>Caltagirone 114</b> | <b>TD</b> | FABRIC <b>Yoredale</b> , FABRIC <b>Remix 3</b>   |
| <b>TE</b> | FABRIC <b>Uniform Melange</b>   | <b>SF</b> | LEATHER <b>Fiore</b>   |
| <b>SV</b> | LEATHER <b>Vintage</b>  |           |  |

**COM/COL - Minimum Q.ty 6 pc. for each material. For weft or patterned fabrics see specific pages**

|            |                        |            |               |
|------------|------------------------|------------|---------------|
| <b>COM</b> | Mtl. 0.87 h. 1.40 Each | <b>COL</b> | Mq. 1.10 Each |
|------------|------------------------|------------|---------------|

**Optionals:**

|              | Value   | Options/notes  |
|--------------|---------|--|
| <b>FM-M2</b> | + 48 €  | ASH GREY <b>ES</b> , BLUE SAPPHIRE <b>EE</b> , BLUE TURQUOISE <b>EH</b> , BRONZE <b>E2</b> , BULGARO RED <b>FP</b> , CHERRY RED <b>EQ</b> , DARK GREEN <b>EL</b> , FACEPOWDER PINK <b>E8</b> , FANGO <b>E3</b> , GOLDEN YELLOW <b>EO</b> , LIGHT BLUE <b>ED</b> , LIGHT GREY <b>ET</b> , OCEAN BLUE <b>E1</b> , OCHER YELLOW <b>E7</b> , PAPAYA ORANGE <b>EA</b> , PASTEL YELLOW <b>E4</b> , PINE GREEN <b>EJ</b> , RED <b>ER</b> , SAGE GREEN <b>E9</b> |
| <b>FM-M3</b> | + 48 €  | CHROME <b>CC</b>   |
| <b>FM-M4</b> | + 108 € | BLACK NICKEL <b>DZ</b> , CHAMPAGNE GOLD <b>DG</b> , GOLDEN BRONZE <b>DB</b> , MATT BLACK NICKEL <b>DY</b> , MATT GOLDEN BRONZE <b>DC</b> , PINK GOLD <b>DR</b>   |
| <b>ES-1</b>  | + 6 €   | ES-1   |
| <b>PD-F0</b> | + 6 €   | PD-F0  |

**Liù S\_M**

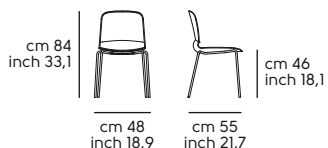

**Liù S\_T**

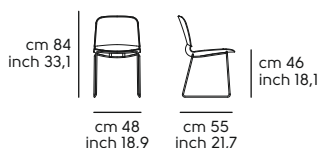

**Liù S\_X**

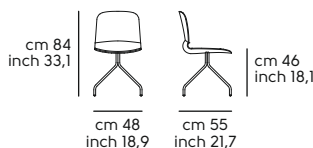

**Liù S\_R**

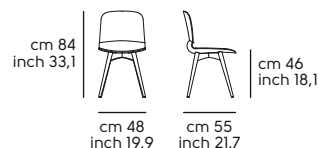

**Liù S ML**

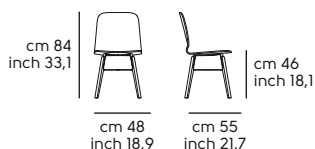

**Liù P M**

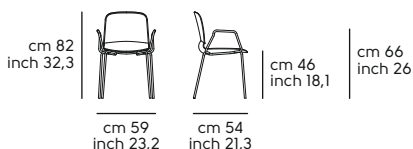

**Liù S DS**

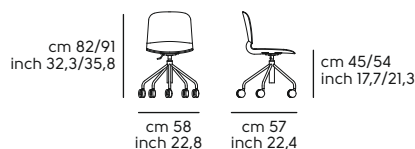



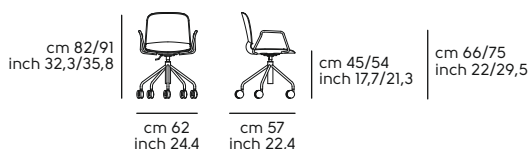





**Liù P DP**



**LIÙ S, P, D, DP - Shell in fabric or leather with wrinkles**

Frame in: metal or wood or metal-wood

| Model   | Code      | Base type | Frame  | Shell |       |       |       |       |       |       |       |       | Optional                                 | Q.ty   | boxes  | Kg         | M <sup>3</sup> |
|---|-----------|-----------|--------|-------|-------|-------|-------|-------|-------|-------|-------|-------|--|--------|--------|------------|----------------|
|   |           |           |        | TA    | TB    | TC    | TD    | TE    | SF    | SV    | COM   | COL   |  |        |        |            |                |
| <b>Chair LIÙ S M TS2_M</b><br>       | S1280SU_M | _M        | M1     | 282 € | 308 € | 344 € | 365 € | 454 € | 390 € | 465 € | 282 € | 344 € | FM-M2<br>FM-M3<br>FM-M4<br>ES-1<br>PD-F0 | 2<br>4 | 1<br>1 | 16<br>24.0 | 0.34<br>0.46   |
| <b>Chair LIÙ S M TS2_T</b><br>       | S1280SU_T | _T        | M1     | 306 € | 332 € | 368 € | 389 € | 478 € | 414 € | 489 € | 306 € | 368 € | FM-M2<br>FM-M3<br>FM-M4<br>ES-1          | 2<br>4 | 1<br>1 | 16<br>24.0 | 0.34<br>0.46   |
| <b>Chair LIÙ S M TS2_X</b><br>       | S1280SU_X | _X        | M1     | 303 € | 329 € | 365 € | 386 € | 475 € | 411 € | 486 € | 303 € | 365 € | FM-M2<br>FM-M3<br>FM-M4<br>ES-1<br>PD-F0 | 2      | 1      | 16         | 0.34           |
| <b>Chair LIÙ S L TS2_R</b><br>      | S1280WU_R | _R        | LF1    | 378 € | 404 € | 438 € | 460 € | 549 € | 486 € | 560 € | 378 € | 438 € | ES-1<br>PD-F0                            | 2      | 1      | 14         | 0.35           |
| <b>Chair LIÙ S ML TS2</b><br>      | S1285MU   | ML        | LF1-M1 | 406 € | 431 € | 465 € | 488 € | 576 € | 513 € | 588 € | 406 € | 465 € | FM-M2<br>ES-1<br>PD-F0                   | 2      | 1      | 12         | 0.28           |
| <b>Armchair LIÙ P M TS2</b><br>    | S1280PU   | M         | M1     | 331 € | 356 € | 392 € | 414 € | 502 € | 439 € | 514 € | 331 € | 392 € | FM-M2<br>FM-M3<br>FM-M4<br>ES-1<br>PD-F0 | 2<br>4 | 1<br>1 | 14<br>31.0 | 0.36<br>0.51   |
| <b>Office Chair LIÙ DS TS2</b><br> | S1280DU   | DS        | M1     | 467 € | 493 € | 530 € | 550 € | 640 € | 575 € | 650 € | 467 € | 530 € | FM-M2<br>FM-M3<br>ES-1                   | 1      | 2      | 10.5       | 0.28           |
| <b>Office Arm. LIÙ DP TS2</b><br>  | S1280EU   | DP        | M1     | 516 € | 543 € | 576 € | 599 € | 687 € | 625 € | 699 € | 516 € | 576 € | FM-M2<br>FM-M3<br>ES-1                   | 1      | 2      | 11         | 0.35           |

**Frame finishes**

**Metal**

|           |   |
|-----------|---|
| <b>MI</b> | WHITE <b>BB</b> , BROWN <b>E6</b> , SAND <b>EC</b> , WHITE PEARL <b>EF</b> , GRAPHITE <b>EG</b> , BLACK <b>EN</b> |
|-----------|---|

**Wood**

|            |  |
|------------|--|
| <b>LFI</b> | Ash wood stained BLACK <b>F04</b> , Ash wood stained WHITE <b>F05</b> , Ash wood stained CHERRY RED <b>F09</b> , Ash wood stained FLAMED WALNUT <b>F24</b> , Ash wood stained DARK BROWN <b>F26</b> , Ash wood stained NATURAL <b>F40</b> , Ash wood stained NATURAL OAK <b>F52</b> , Ash wood stained WHITENED <b>F60</b> , Ash wood stained DESERT <b>F61</b> , Ash wood stained LIGHT GREY <b>F62</b> , Ash wood stained DARK GREY <b>F63</b> |
|------------|--|

**Insert finishes**

**Metal**



|           |   |
|-----------|---|
| <b>MI</b> | WHITE <b>BB</b> , BROWN <b>E6</b> , SAND <b>EC</b> , WHITE PEARL <b>EF</b> , GRAPHITE <b>EG</b> , BLACK <b>EN</b> |
|-----------|---|

**Shell finishes**

**Upholstery**

|           |   |           |  |
|-----------|---|-----------|--|
| <b>TA</b> | FAUX LEATHER <b>Secret</b> , FABRIC <b>Mirage</b> , FABRIC <b>Cotton Club</b> , FABRIC <b>Renewed Loop</b>  | <b>TB</b> | FAUX LEATHER <b>Vintage</b> , FABRIC <b>Fenix Wool</b> , FABRIC <b>Visual</b> , FABRIC <b>Manhattan</b> , FABRIC <b>Novabuk</b> , FABRIC <b>Network</b> , FABRIC <b>Gyre</b> |
| <b>TC</b> | VELVET SUPERB, FABRIC <b>Second</b> , FABRIC <b>Main Line Flax</b> , FABRIC <b>Oceanic</b> , FABRIC <b>Jumper</b> , FABRIC <b>Flame</b> , FABRIC <b>Ouche</b> , FABRIC <b>Plain</b> , FABRIC <b>Gemma</b> , FABRIC <b>Caltagirone 114</b> | <b>TD</b> | FABRIC <b>Yoredale</b> , FABRIC <b>Remix 3</b>   |
| <b>TE</b> | FABRIC <b>Uniform Melange</b>   | <b>SF</b> | LEATHER <b>Fiore</b>   |
| <b>SV</b> | LEATHER <b>Vintage</b>  |           |  |

**COM/COL - Minimum Q.ty 6 pc. for each material. For weft or patterned fabrics see specific pages**

|   |                        |  |               |
|---|------------------------|--|---------------|
|  <b>COM</b> | Mtl. 0.75 h. 1.40 Each |  <b>COL</b> | Mq. 1.10 Each |
|---|------------------------|--|---------------|

**Optionals:**

|              | Value   | Options/notes  |
|--------------|---------|--|
| <b>FM-M2</b> | + 48 €  | ASH GREY <b>ES</b> , BLUE SAPPHIRE <b>EE</b> , BLUE TURQUOISE <b>EH</b> , BRONZE <b>E2</b> , BULGARO RED <b>FP</b> , CHERRY RED <b>EQ</b> , DARK GREEN <b>EL</b> , FACEPOWDER PINK <b>E8</b> , FANGO <b>E3</b> , GOLDEN YELLOW <b>EO</b> , LIGHT BLUE <b>EO</b> , LIGHT GREY <b>ET</b> , OCEAN BLUE <b>E1</b> , OCHER YELLOW <b>E7</b> , PAPAYA ORANGE <b>EA</b> , PASTEL YELLOW <b>E4</b> , PINE GREEN <b>EJ</b> , RED <b>ER</b> , SAGE GREEN <b>E9</b> |
| <b>FM-M3</b> | + 48 €  | CHROME <b>CC</b>   |
| <b>FM-M4</b> | + 108 € | BLACK NICKEL <b>DZ</b> , CHAMPAGNE GOLD <b>DG</b> , GOLDEN BRONZE <b>DB</b> , MATT BLACK NICKEL <b>DY</b> , MATT GOLDEN BRONZE <b>DC</b> , PINK GOLD <b>DR</b>   |
| <b>ES-1</b>  | + 6 €   | ES-1   |
| <b>PD-F0</b> | + 6 €   | PD-F0  |

**Liù S\_M**

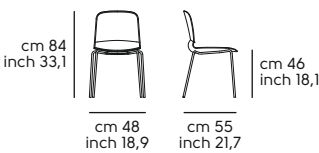

**Liù S\_T**

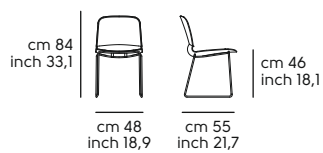

**Liù S\_X**

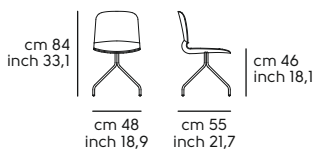

**Liù S\_R**



**Liù S ML**

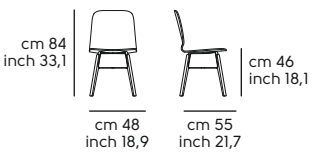

**Liù P M**

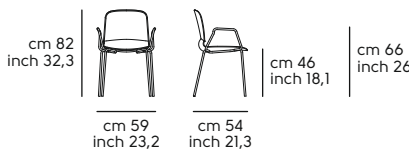

**Liù S DS**

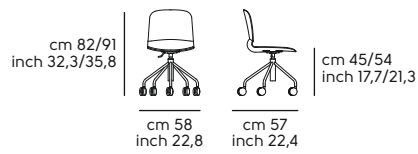



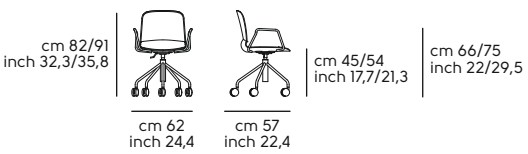







**Liù P DP**



**Liù H65-75-SG - Wood shell**

Frame in: metal, metal-wood, wood

| Model   | Code    | Mod.   | Frame  | Shell |       | Optional                         | Q.ty | boxes | Kg   | M <sup>3</sup> |
|---|---------|--------|--------|-------|-------|----------------------------------|------|-------|------|----------------|
|   |         |        |        | LI1   | LI2   |                                  |      |       |      |                |
| <b>Stool LIÙ H65 M LG</b><br>   | S1280HL | H65    | M1     | 330 € | 344 € | FM-M2<br>FM-M3<br>FM-M4<br>PD-F0 | 2    | 1     | 14   | 0.24           |
| <b>Stool LIÙ H75 M LG</b><br>   | S1280JL | H75    | M1     | 345 € | 360 € | FM-M2<br>FM-M3<br>FM-M4<br>PD-F0 | 2    | 1     | 16   | 0.31           |
| <b>Stool LIÙ H65 ML LG</b><br>   | S1285HL | ML H65 | LF1-M1 | 493 € | 508 € | FM-M2<br>PD-F0                   | 1    | 1     | 14   | 0.24           |
| <b>Stool LIÙ H75 ML LG</b><br>  | S1285JL | ML H75 | LF1-M1 | 509 € | 518 € | FM-M2<br>PD-F0                   | 1    | 1     | 16   | 0.31           |
| <b>Stool LIÙ H65 LR-LG</b><br>   | S1280HI | LR H65 | LF1    | 445 € | 460 € | PD-F0                            | 1    | 1     | 6.55 | 0.21           |
| <b>Stool LIÙ H75 LR-LG</b><br>   | S1280JI | LR H75 | LF1    | 465 € | 479 € | PD-F0                            | 1    | 1     | 6.85 | 0.24           |
| <b>Stool LIÙ SG LG</b><br>  | S1280ZL | SG     | M1     | 607 € | 622 € | FM-M2                            | 1    | 1     | 16   | 0.21           |

**Frame finishes**

**Metal**

|           |   |
|-----------|---|
| <b>MI</b> | WHITE <b>BB</b> , BROWN <b>E6</b> , SAND <b>EC</b> , WHITE PEARL <b>EF</b> , GRAPHITE <b>EG</b> , BLACK <b>EN</b> |
|-----------|---|

**Wood**

|            |  |
|------------|--|
| <b>LFI</b> | Ash wood stained BLACK <b>F04</b> , Ash wood stained WHITE <b>F05</b> , Ash wood stained CHERRY RED <b>F09</b> , Ash wood stained FLAMED WALNUT <b>F24</b> , Ash wood stained DARK BROWN <b>F26</b> , Ash wood stained NATURAL <b>F40</b> , Ash wood stained NATURAL OAK <b>F52</b> , Ash wood stained WHITENED <b>F60</b> , Ash wood stained DESERT <b>F61</b> , Ash wood stained LIGHT GREY <b>F62</b> , Ash wood stained DARK GREY <b>F63</b> |
|------------|--|

**Insert finishes**

**Metal**

|           |   |
|-----------|---|
| <b>MI</b> | WHITE <b>BB</b> , BROWN <b>E6</b> , SAND <b>EC</b> , WHITE PEARL <b>EF</b> , GRAPHITE <b>EG</b> , BLACK <b>EN</b> |
|-----------|---|

**Shell finishes**

**Wood**

|            |  |
|------------|--|
| <b>LII</b> | Veneered wood painted BLACK <b>I04</b> , Veneered wood painted WHITE <b>I05</b> , Veneered wood painted CHERRY RED <b>I09</b> , Veneered wood painted DARK BROWN <b>I26</b> , Veneered wood painted NATURAL <b>I40</b> , Veneered wood painted NATURAL OAK <b>I52</b> , Veneered wood painted WHITENED <b>I60</b> , Veneered wood painted DESERT <b>I61</b> , Veneered wood painted LIGHT GREY <b>I62</b> , Veneered wood painted DARK GREY <b>I63</b> |
| <b>LII</b> | Veneered wood NATURAL OAK <b>I22</b> , Veneered wood FLAMED WALNUT <b>I24</b>  |

**Optionals:**

|              |                        | Value   | Options/notes  |
|--------------|------------------------|---------|--|
| <b>FM-M2</b> | Indoor matt metal M2   | + 48 €  | ASH GREY <b>ES</b> , BLUE SAPPHIRE <b>EE</b> , BLUE TURQUOISE <b>EH</b> , BRONZE <b>E2</b> , BULGARO RED <b>FP</b> , CHERRY RED <b>EQ</b> , DARK GREEN <b>EL</b> , FACEPOWDER PINK <b>E8</b> , FANGO <b>E3</b> , GOLDEN YELLOW <b>EO</b> , LIGHT BLUE <b>EO</b> , LIGHT GREY <b>ET</b> , OCEAN BLUE <b>E1</b> , OCHER YELLOW <b>E7</b> , PAPAYA ORANGE <b>EA</b> , PASTEL YELLOW <b>E4</b> , PINE GREEN <b>EJ</b> , RED <b>ER</b> , SAGE GREEN <b>E9</b> |
| <b>FM-M3</b> | Indoor glossy metal M3 | + 48 €  | CHROME <b>CC</b>   |
| <b>FM-M4</b> | Indoor glossy Metal M4 | + 108 € | BLACK NICKEL <b>DZ</b> , CHAMPAGNE GOLD <b>DG</b> , GOLDEN BRONZE <b>DB</b> , MATT BLACK NICKEL <b>DY</b> , MATT GOLDEN BRONZE <b>DC</b> , PINK GOLD <b>DR</b>   |
| <b>PD-F0</b> | Felt pad feet          | + 6 €   | PD-F0  |

**Liù H65**

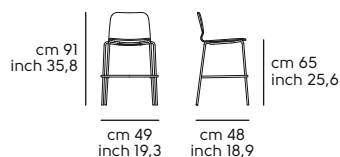

**Liù H75**

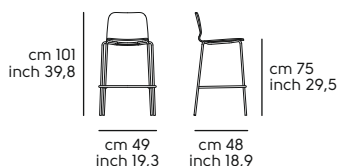

**Liù ML H65**

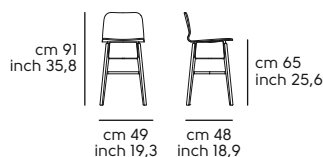

**Liù ML H75**

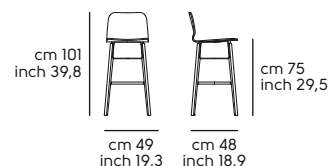

**Liù LR H65**

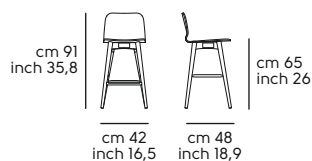

**Liù LR H75**

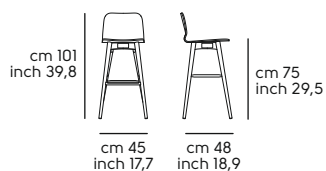



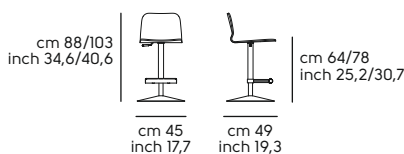







**Liù SG**



**Liù H65-75-SG - Shell in fabric or leather with wrinkles**

Frame in: metal, metal-wood, wood

| Model  | Code    | Mod.   | Frame  | Shell |       |       |       |       |       |       |       |       | Optional                                 | Q.ty | boxes | Kg   | M <sup>3</sup> |
|--|---------|--------|--------|-------|-------|-------|-------|-------|-------|-------|-------|-------|--|------|-------|------|----------------|
|  |         |        |        | TA    | TB    | TC    | TD    | TE    | SF    | SV    | COM   | COL   |  |      |       |      |                |
| <b>Stool LIÙ H65 M TS2</b><br>   | S1280HU | H65    | M1     | 331 € | 345 € | 371 € | 388 € | 448 € | 438 € | 589 € | 331 € | 371 € | FM-M2<br>FM-M3<br>FM-M4<br>ES-1<br>PD-F0 | 2    | 1     | 14   | 0.28           |
| <b>Stool LIÙ H75 M TS2</b><br>   | S1280JU | H75    | M1     | 345 € | 360 € | 386 € | 401 € | 463 € | 452 € | 601 € | 345 € | 386 € | FM-M2<br>FM-M3<br>FM-M4<br>ES-1<br>PD-F0 | 2    | 1     | 16   | 0.33           |
| <b>Stool LIÙ H65 ML TS2</b><br>   | S1285HU | ML H65 | LF1-M1 | 486 € | 498 € | 525 € | 543 € | 604 € | 593 € | 755 € | 486 € | 525 € | FM-M2<br>ES-1<br>PD-F0                   | 1    | 1     | 14   | 0.24           |
| <b>Stool LIÙ H75 ML TS2</b><br>  | S1285JU | ML H75 | LF1-M1 | 498 € | 513 € | 538 € | 554 € | 617 € | 604 € | 769 € | 498 € | 538 € | FM-M2<br>ES-1<br>PD-F0                   | 1    | 1     | 16   | 0.31           |
| <b>Stool LIÙ H65 LR-TS2</b><br>   | S1280HJ | LR H65 | LF1    | 446 € | 461 € | 488 € | 503 € | 565 € | 553 € | 704 € | 446 € | 488 € | ES-1<br>PD-F0                            | 1    | 1     | 7.05 | 0.21           |
| <b>Stool LIÙ H75 LR-TS2</b><br>   | S1280JJ | LR H75 | LF1    | 465 € | 479 € | 506 € | 522 € | 583 € | 572 € | 721 € | 465 € | 506 € | ES-1<br>PD-F0                            | 1    | 1     | 7.35 | 0.24           |
| <b>Stool LIÙ SG TS2</b><br>  | S1280ZU | SG     | M1     | 574 € | 588 € | 615 € | 630 € | 693 € | 680 € | 832 € | 574 € | 615 € | FM-M2<br>ES-1                            | 1    | 1     | 16.5 | 0.21           |

**Frame finishes**

**Metal**

|           |   |
|-----------|---|
| <b>MI</b> | WHITE <b>BB</b> , BROWN <b>E6</b> , SAND <b>EC</b> , WHITE PEARL <b>EF</b> , GRAPHITE <b>EG</b> , BLACK <b>EN</b> |
|-----------|---|

**Wood**

|            |  |
|------------|--|
| <b>LFI</b> | Ash wood stained BLACK <b>F04</b> , Ash wood stained WHITE <b>F05</b> , Ash wood stained CHERRY RED <b>F09</b> , Ash wood stained FLAMED WALNUT <b>F24</b> , Ash wood stained DARK BROWN <b>F26</b> , Ash wood stained NATURAL <b>F40</b> , Ash wood stained NATURAL OAK <b>F52</b> , Ash wood stained WHITENED <b>F60</b> , Ash wood stained DESERT <b>F61</b> , Ash wood stained LIGHT GREY <b>F62</b> , Ash wood stained DARK GREY <b>F63</b> |
|------------|--|

**Insert finishes**

**Metal**



|           |   |
|-----------|---|
| <b>MI</b> | WHITE <b>BB</b> , BROWN <b>E6</b> , SAND <b>EC</b> , WHITE PEARL <b>EF</b> , GRAPHITE <b>EG</b> , BLACK <b>EN</b> |
|-----------|---|

**Shell finishes**

**Upholstery**

|           |   |           |  |
|-----------|---|-----------|--|
| <b>TA</b> | FAUX LEATHER <b>Secret</b> , FABRIC <b>Mirage</b> , FABRIC <b>Cotton Club</b> , FABRIC <b>Renewed Loop</b>  | <b>TB</b> | FAUX LEATHER <b>Vintage</b> , FABRIC <b>Fenix Wool</b> , FABRIC <b>Visual</b> , FABRIC <b>Manhattan</b> , FABRIC <b>Novabuk</b> , FABRIC <b>Network</b> , FABRIC <b>Gyre</b> |
| <b>TC</b> | VELVET SUPERB, FABRIC <b>Second</b> , FABRIC <b>Main Line Flax</b> , FABRIC <b>Oceanic</b> , FABRIC <b>Jumper</b> , FABRIC <b>Flame</b> , FABRIC <b>Ouche</b> , FABRIC <b>Plain</b> , FABRIC <b>Gemma</b> , FABRIC <b>Caltagirone 114</b> | <b>TD</b> | FABRIC <b>Yoredale</b> , FABRIC <b>Remix 3</b>   |
| <b>TE</b> | FABRIC <b>Uniform Melange</b>   | <b>SF</b> | LEATHER <b>Fiore</b>   |
| <b>SV</b> | LEATHER <b>Vintage</b>  |           |  |

**COM/COL - Minimum Q.ty 6 pc. for each material. For weft or patterned fabrics see specific pages**

|   |                        |  |               |
|---|------------------------|--|---------------|
|  <b>COM</b> | Mtl. 0.60 h. 1.40 Each |  <b>COL</b> | Mq. 0.90 Each |
|---|------------------------|--|---------------|

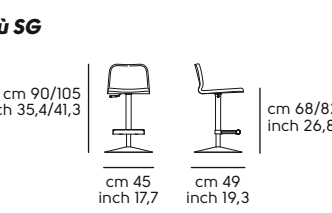
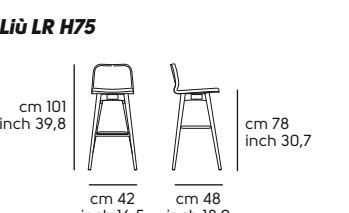
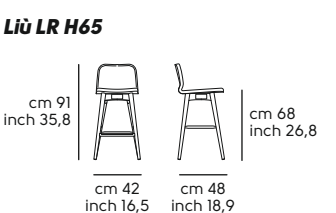
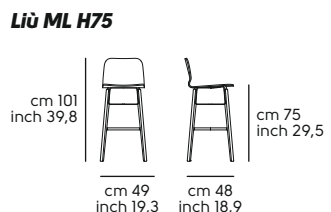
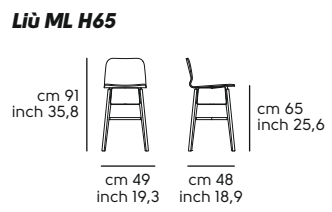
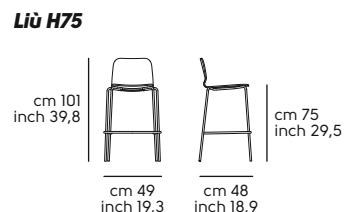
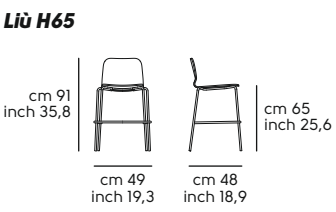

**Optionals:**

|              | Value   | Options/notes  |
|--------------|---------|--|
| <b>FM-M2</b> | + 48 €  | ASH GREY <b>ES</b> , BLUE SAPPHIRE <b>EE</b> , BLUE TURQUOISE <b>EH</b> , BRONZE <b>E2</b> , BULGARO RED <b>FP</b> , CHERRY RED <b>EQ</b> , DARK GREEN <b>EL</b> , FACEPOWDER PINK <b>E8</b> , FANGO <b>E3</b> , GOLDEN YELLOW <b>EO</b> , LIGHT BLUE <b>EO</b> , LIGHT GREY <b>ET</b> , OCEAN BLUE <b>E1</b> , OCHER YELLOW <b>E7</b> , PAPAYA ORANGE <b>EA</b> , PASTEL YELLOW <b>E4</b> , PINE GREEN <b>EJ</b> , RED <b>ER</b> , SAGE GREEN <b>E9</b> |
| <b>FM-M3</b> | + 48 €  | CHROME <b>CC</b>   |
| <b>FM-M4</b> | + 108 € | BLACK NICKEL <b>DZ</b> , CHAMPAGNE GOLD <b>DG</b> , GOLDEN BRONZE <b>DB</b> , MATT BLACK NICKEL <b>DY</b> , MATT GOLDEN BRONZE <b>DC</b> , PINK GOLD <b>DR</b>   |
| <b>ES-1</b>  | + 6 €   | ES-1   |
| <b>PD-F0</b> | + 6 €   | PD-F0  |



## Liù AT - Shell in fabric or leather with wrinkles

Frame in: metal, metal-wood, wood

| Model   | Code    | Mod.  | Frame  | Shell |       |       |       |       |       |       |       |       | Optional               | Q.ty | boxes | Kg | M <sup>3</sup> |
|---|---------|-------|--------|-------|-------|-------|-------|-------|-------|-------|-------|-------|------------------------|------|-------|----|----------------|
|   |         |       |        | TA    | TB    | TC    | TD    | TE    | SF    | SV    | COM   | COL   |                        |      |       |    |                |
| <br>Waiting Chair <b>LIÙ AT M TS2</b>  | S1280AU | AT    | M1     | 400 € | 416 € | 482 € | 525 € | 656 € | 515 € | 621 € | 400 € | 482 € | FM-M2<br>ES-1<br>PD-F0 | 1    | 1     | 8  | 0.35           |
| <br>Waiting Chair <b>LIÙ AT ML TS2</b> | S1285AU | ML AT | LFI-M1 | 535 € | 551 € | 617 € | 658 € | 790 € | 650 € | 756 € | 535 € | 617 € | FM-M2<br>ES-1<br>PD-F0 | 1    | 1     | 8  | 0.35           |

### Frame finishes

#### Metal

|           |   |
|-----------|---|
| <b>MI</b> | WHITE <b>BB</b> , BROWN <b>E6</b> , SAND <b>EC</b> , WHITE PEARL <b>EF</b> , GRAPHITE <b>EG</b> , BLACK <b>EN</b> |
|-----------|---|

#### Wood

|            |  |
|------------|--|
| <b>LFI</b> | Ash wood stained BLACK <b>F04</b> , Ash wood stained WHITE <b>F05</b> , Ash wood stained CHERRY RED <b>F09</b> , Ash wood stained FLAMED WALNUT <b>F24</b> , Ash wood stained DARK BROWN <b>F26</b> , Ash wood stained NATURAL <b>F40</b> , Ash wood stained NATURAL OAK <b>F52</b> , Ash wood stained WHITENED <b>F60</b> , Ash wood stained DESERT <b>F61</b> , Ash wood stained LIGHT GREY <b>F62</b> , Ash wood stained DARK GREY <b>F63</b> |
|------------|--|

### Insert finishes

#### Metal

|           |   |
|-----------|---|
| <b>MI</b> | WHITE <b>BB</b> , BROWN <b>E6</b> , SAND <b>EC</b> , WHITE PEARL <b>EF</b> , GRAPHITE <b>EG</b> , BLACK <b>EN</b> |
|-----------|---|

### Shell finishes

#### Upholstery

|           |   |           |  |
|-----------|---|-----------|--|
| <b>TA</b> | FAUX LEATHER <b>Secret</b> , FABRIC <b>Mirage</b> , FABRIC <b>Cotton Club</b> , FABRIC <b>Renewed Loop</b>  | <b>TB</b> | FAUX LEATHER <b>Vintage</b> , FABRIC <b>Fenix Wool</b> , FABRIC <b>Visual</b> , FABRIC <b>Manhattan</b> , FABRIC <b>Novabuk</b> , FABRIC <b>Network</b> , FABRIC <b>Gyre</b> |
| <b>TC</b> | VELVET SUPERB, FABRIC <b>Second</b> , FABRIC <b>Main Line Flax</b> , FABRIC <b>Oceanic</b> , FABRIC <b>Jumper</b> , FABRIC <b>Flame</b> , FABRIC <b>Ouche</b> , FABRIC <b>Plain</b> , FABRIC <b>Gemma</b> , FABRIC <b>Caltagirone 114</b> | <b>TD</b> | FABRIC <b>Yoredale</b> , FABRIC <b>Remix 3</b>   |
| <b>TE</b> | FABRIC <b>Uniform Melange</b>   | <b>SF</b> | LEATHER <b>Fiore</b>   |
| <b>SV</b> | LEATHER <b>Vintage</b>  |           |  |

COM/COL - Minimum Q.ty 6 pc. for each material. For weft or patterned fabrics see specific pages

|            |                        |            |               |
|------------|------------------------|------------|---------------|
| <b>COM</b> | Mtl. 1.30 h. 1.40 Each | <b>COL</b> | Mq. 1.60 Each |
|------------|------------------------|------------|---------------|

### Optionals:

|              | Value  | Options/notes  |
|--------------|--------|--|
| <b>FM-M2</b> | + 54 € | ASH GREY <b>ES</b> , BLUE SAPPHIRE <b>EE</b> , BLUE TURQUOISE <b>EH</b> , BRONZE <b>E2</b> , BULGARO RED <b>FP</b> , CHERRY RED <b>EQ</b> , DARK GREEN <b>EL</b> , FACEPOWDER PINK <b>E8</b> , FANGO <b>E3</b> , GOLDEN YELLOW <b>EO</b> , LIGHT BLUE <b>EO</b> , LIGHT GREY <b>ET</b> , OCEAN BLUE <b>E1</b> , OCHER YELLOW <b>E7</b> , PAPAYA ORANGE <b>EA</b> , PASTEL YELLOW <b>E4</b> , PINE GREEN <b>EJ</b> , RED <b>ER</b> , SAGE GREEN <b>E9</b> |
| <b>ES-1</b>  | + 7 €  | ES-1   |
| <b>PD-F0</b> | + 6 €  | PD-F0  |

#### Liù AT

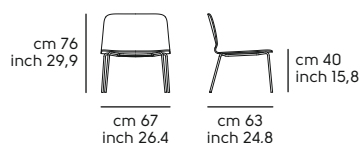

#### Liù ML AT

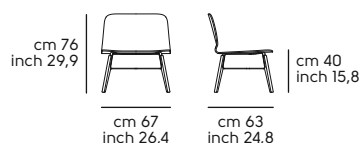



# Maya design Balutto Associati

## Maya S, H65-75 - Seat in wood, fabric or leather

Frame and Back in Wood

| Model  | Code    | Mod. | Frame and Backrest | Seat  |  |  |  |  |  |  |  |  | Optional | Q.ty | boxes | Kg | M <sup>3</sup> |
|--|---------|------|--------------------|-------|--|--|--|--|--|--|--|--|----------|------|-------|----|----------------|
| LFI  |         |      |                    |       |  |  |  |  |  |  |  |  |          |      |       |    |                |
| <b>Chair MAYA S L LG</b><br> | S1860SW | S    | LFI                | 342 € |  |  |  |  |  |  |  |  | PD-FO    | 2    | 1     | 12 | 0.28           |

| Model  | Code    | Mod. | Frame and Backrest | TA    | TB    | TC    | TD    | TE    | SF    | SV    | COM   | COL   | Optional      | Q.ty | boxes | Kg | M <sup>3</sup> |
|--|---------|------|--------------------|-------|-------|-------|-------|-------|-------|-------|-------|-------|---------------|------|-------|----|----------------|
| <b>Chair MAYA S L TS</b><br> | S1860ST | S    | LFI                | 316 € | 342 € | 366 € | 380 € | 460 € | 380 € | 442 € | 316 € | 366 € | ES-1<br>PD-FO | 2    | 1     | 12 | 0.28           |

| Model  | Code    | Mod. | Frame and Backrest | Seat  |  |  |  |  |  |  |  |  | Optional | Q.ty | boxes | Kg  | M <sup>3</sup> |
|--|---------|------|--------------------|-------|--|--|--|--|--|--|--|--|----------|------|-------|-----|----------------|
| LFI  |         |      |                    |       |  |  |  |  |  |  |  |  |          |      |       |     |                |
| <b>Stool MAYA H65 L LG</b><br>                                     | S1860HW | H65  | LFI                | 433 € |  |  |  |  |  |  |  |  | PD-FO    | 1    | 1     | 6.5 | 0.31           |
| <b>Stool MAYA H75 L LG</b><br><br><small>CATAS<br/>DN 1728</small> | S1860JW | H75  | LFI                | 444 € |  |  |  |  |  |  |  |  | PD-FO    | 1    | 1     | 7.5 | 0.34           |

| Model  | Code    | Mod. | Frame and Backrest | TA    | TB    | TC    | TD    | TE    | SF    | SV    | COM   | COL   | Optional      | Q.ty | boxes | Kg  | M <sup>3</sup> |
|--|---------|------|--------------------|-------|-------|-------|-------|-------|-------|-------|-------|-------|---------------|------|-------|-----|----------------|
| <b>Stool MAYA H65 L TS</b><br>                                     | S1860HT | H65  | LFI                | 420 € | 445 € | 470 € | 484 € | 564 € | 484 € | 547 € | 420 € | 470 € | ES-1<br>PD-FO | 1    | 1     | 6.5 | 0.31           |
| <b>Stool MAYA H75 L TS</b><br><br><small>CATAS<br/>DN 1728</small> | S1860JT | H75  | LFI                | 435 € | 460 € | 484 € | 498 € | 577 € | 498 € | 560 € | 435 € | 484 € | ES-1<br>PD-FO | 1    | 1     | 7.5 | 0.34           |

**Frame and Back finishes**

**Wood**

|            |  |
|------------|--|
| <b>LFI</b> | Ash wood stained BLACK <b>F04</b> , Ash wood stained WHITE <b>F05</b> , Ash wood stained CHERRY RED <b>F09</b> , Ash wood stained FLAMED WALNUT <b>F24</b> , Ash wood stained DARK BROWN <b>F26</b> , Ash wood stained NATURAL <b>F40</b> , Ash wood stained NATURAL OAK <b>F52</b> , Ash wood stained WHITENED <b>F60</b> , Ash wood stained DESERT <b>F61</b> , Ash wood stained LIGHT GREY <b>F62</b> , Ash wood stained DARK GREY <b>F63</b> |
|------------|--|

**Seat finishes**

**Wood**

|            |  |
|------------|--|
| <b>LFI</b> | Ash wood stained BLACK <b>F04</b> , Ash wood stained WHITE <b>F05</b> , Ash wood stained CHERRY RED <b>F09</b> , Ash wood stained FLAMED WALNUT <b>F24</b> , Ash wood stained DARK BROWN <b>F26</b> , Ash wood stained NATURAL <b>F40</b> , Ash wood stained NATURAL OAK <b>F52</b> , Ash wood stained WHITENED <b>F60</b> , Ash wood stained DESERT <b>F61</b> , Ash wood stained LIGHT GREY <b>F62</b> , Ash wood stained DARK GREY <b>F63</b> |
|------------|--|

**Upholstery**

|           |   |
|-----------|---|
| <b>TA</b> | FAUX LEATHER <b>Secret</b> , FABRIC <b>Mirage</b> , FABRIC <b>Cotton Club</b> , FABRIC <b>Renewed Loop</b>  |
| <b>TB</b> | FAUX LEATHER <b>Vintage</b> , FABRIC <b>Fenix Wool</b> , FABRIC <b>Visual</b> , FABRIC <b>Manhattan</b> , FABRIC <b>Novabuk</b> , FABRIC <b>Network</b> , FABRIC <b>Gyre</b>  |
| <b>TC</b> | VELVET SUPERB, FABRIC <b>Second</b> , FABRIC <b>Main Line Flax</b> , FABRIC <b>Oceanic</b> , FABRIC <b>Jumper</b> , FABRIC <b>Flame</b> , FABRIC <b>Ouche</b> , FABRIC <b>Plain</b> , FABRIC <b>Gemma</b> , FABRIC <b>Caltagirone 114</b> |

**Shell finishes**

**Upholstery**



|           |  |           |                               |
|-----------|--|-----------|-------------------------------|
| <b>TD</b> | FABRIC <b>Yoredale</b> , FABRIC <b>Remix 3</b> | <b>TE</b> | FABRIC <b>Uniform Melange</b> |
|-----------|--|-----------|-------------------------------|

**Seat finishes**

**Upholstery**

|           |                        |
|-----------|------------------------|
| <b>SF</b> | LEATHER <b>Fiore</b>   |
| <b>SV</b> | LEATHER <b>Vintage</b> |

**COM/COL - Minimum Q.ty 6 pc. for each material. For weft or patterned fabrics see specific pages**

|   |                        |   |               |
|---|------------------------|---|---------------|
| <b>COM</b><br> | Mtl. 0.55 h. 1.40 Each | <b>COL</b><br> | Mq. 0.68 Each |
|---|------------------------|---|---------------|

**Optionals:**

|              |                | Value | Options/notes |
|--------------|----------------|-------|---------------|
| <b>ES-1</b>  | Fireproof foam | + 6 € | ES-1          |
| <b>PD-F0</b> | Felt pad feet  | + 6 € | PD-F0         |

**Maya S**

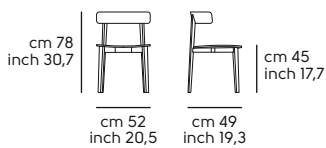

**Maya H65**

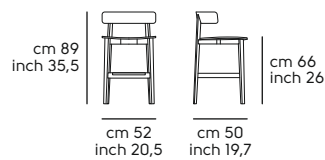



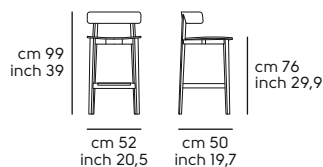



**Maya H75**





# Master design Paolo Vernier

**Master S, H65-75 - Seat and back in hide, fabric or leather, wood**

Frame in: metal

| Model   | Code    | Mod. | Frame | Seat and Backrest |       |       |       |       |       |       |       | Optional               | G.ty                   | boxes | Kg  | M <sup>3</sup> |      |
|---|---------|------|-------|-------------------|-------|-------|-------|-------|-------|-------|-------|------------------------|------------------------|-------|-----|----------------|------|
|   |         |      |       | CU                |       |       |       | CT    |       |       |       |                        |                        |       |     |                |      |
| <b>Chair MASTER S M CU</b>  |         |      |       |                   |       |       |       |       |       |       |       |                        |                        |       |     |                |      |
| <br>CATAS EN 1728   | S1710SC | S    | MI    | 450 €             |       |       |       | 541 € |       |       |       | FM-M2<br>FM-M4<br>ES-1 | 2                      | 1     | 14  | 0.19           |      |
| <b>Chair MASTER S M TS</b>  |         |      |       | TA                | TB    | TC    | TD    | TE    | SF    | SV    | COM   | COL                    |                        |       |     |                |      |
| <br>CATAS EN 1728   | S1710ST | S    | MI    | 288 €             | 310 € | 336 € | 353 € | 398 € | 388 € | 425 € | 288 € | 336 €                  | FM-M2<br>FM-M4<br>ES-1 | 2     | 1   | 14             | 0.28 |
| <b>Chair MASTER S M LG</b>  |         |      |       | HF1               |       | LI1   |       |       | LI2   |       |       |                        |                        |       |     |                |      |
| <br>CATAS EN 1728 | S1710SW | S    | MI    | 349 €             |       | 364 € |       |       | 378 € |       |       | FM-M2<br>FM-M4         | 2                      | 1     | 14  | 0.26           |      |
| <b>Stool MASTER H65 M CU</b>  |         |      |       | CU                |       |       |       | CT    |       |       |       |                        |                        |       |     |                |      |
|                   | S1710HC | H65  | MI    | 499 €             |       |       |       | 604 € |       |       |       | FM-M2<br>FM-M4<br>ES-1 | 1                      | 1     | 9   | 0.24           |      |
| <b>Stool MASTER H75 M CU</b>  |         |      |       | CU                |       |       |       | CT    |       |       |       |                        |                        |       |     |                |      |
|                   | S1710JC | H75  | MI    | 527 €             |       |       |       | 635 € |       |       |       | FM-M2<br>FM-M4<br>ES-1 | 1                      | 1     | 9.5 | 0.25           |      |
| <b>Stool MASTER H65 M TS</b>  |         |      |       | TA                | TB    | TC    | TD    | TE    | SF    | SV    | COM   | COL                    |                        |       |     |                |      |
|                   | S1710HT | H65  | MI    | 349 €             | 376 € | 402 € | 419 € | 464 € | 454 € | 492 € | 349 € | 402 €                  | FM-M2<br>FM-M4<br>ES-1 | 1     | 1   | 9              | 0.24 |
| <b>Stool MASTER H75 M TS</b>  |         |      |       | TA                | TB    | TC    | TD    | TE    | SF    | SV    | COM   | COL                    |                        |       |     |                |      |
|                   | S1710JT | H75  | MI    | 361 €             | 390 € | 415 € | 433 € | 477 € | 466 € | 504 € | 361 € | 415 €                  | FM-M2<br>FM-M4<br>ES-1 | 1     | 1   | 9.5            | 0.25 |

|   |   |         |     | HF1   | LI1   | LI2   |                |                |   |   |      |
|---|---|---------|-----|-------|-------|-------|----------------|----------------|---|---|------|
| <br><b>Stool MASTER H65 M LG</b> | S1710HW   | H65     | M1  | 389 € | 401 € | 416 € | FM-M2<br>FM-M4 | 1              | 1 | 9 | 0.22 |
|   | <br><b>Stool MASTER H75 M LG</b> | S1710JW | H75 | M1    | 410 € | 417 € | 438 €          | FM-M2<br>FM-M4 | 1 | 1 | 9.5  |

**Frame finishes**

**Metal**

**M1** WHITE **BB**, BROWN **E6**, SAND **EC**, WHITE PEARL **EF**, GRAPHITE **EG**, BLACK **EN**

**Seat and Back finishes**

**Laminate**

**HF1** Fenix BLACK **FX4**, Fenix WHITE **FX5**

**Wood**

**LI1** Veneered wood painted BLACK **I04**, Veneered wood painted WHITE **I05**, Veneered wood painted CHERRY RED **I09**, Veneered wood painted DARK BROWN **I26**, Veneered wood painted NATURAL **I40**, Veneered wood painted NATURAL OAK **I52**, Veneered wood painted WHITENED **I60**, Veneered wood painted DESERT **I61**, Veneered wood painted LIGHT GREY **I62**, Veneered wood painted DARK GREY **I63**



**LI2** Veneered wood NATURAL OAK **I22**, Veneered wood FLAMED WALNUT **I24**

**Seat and Back finishes**

**Upholstery**

|           |   |           |  |
|-----------|---|-----------|--|
| <b>TA</b> | FAUX LEATHER <b>Secret</b> , FABRIC <b>Mirage</b> , FABRIC <b>Cotton Club</b> , FABRIC <b>Renewed Loop</b>  | <b>TB</b> | FAUX LEATHER <b>Vintage</b> , FABRIC <b>Fenix Wool</b> , FABRIC <b>Visual</b> , FABRIC <b>Manhattan</b> , FABRIC <b>Novabuk</b> , FABRIC <b>Network</b> , FABRIC <b>Gyre</b> |
| <b>TC</b> | VELVET SUPERB, FABRIC <b>Second</b> , FABRIC <b>Main Line Flax</b> , FABRIC <b>Oceanic</b> , FABRIC <b>Jumper</b> , FABRIC <b>Flame</b> , FABRIC <b>Ouche</b> , FABRIC <b>Plain</b> , FABRIC <b>Gemma</b> , FABRIC <b>Caltagirone I14</b> | <b>TD</b> | FABRIC <b>Yoredale</b> , FABRIC <b>Remix 3</b>   |
| <b>TE</b> | FABRIC <b>Uniform Melange</b>   | <b>SF</b> | LEATHER <b>Fiore</b>   |
| <b>SV</b> | LEATHER <b>Vintage</b>  | <b>CU</b> | HIDE   |
| <b>CT</b> | TUSCAN HIDE   |           |  |

**COM/COL - Minimum Q.ty 6 pc. for each material. For weft or patterned fabrics see specific pages**

|  |                        |  |               |
|--|------------------------|--|---------------|
|  <b>COM</b> | Mtl. 0.50 h. 1.40 Each |  <b>COL</b> | Mq. 1.24 Each |
|--|------------------------|--|---------------|

**Optionals:**

|              |                        | Value   | Options/notes  |
|--------------|------------------------|---------|--|
| <b>FM-M2</b> | Indoor matt metal M2   | + 52 €  | ASH GREY <b>ES</b> , BLUE SAPPHIRE <b>EE</b> , BLUE TURQUOISE <b>EH</b> , BRONZE <b>E2</b> , BULGARO RED <b>FP</b> , CHERRY RED <b>EQ</b> , DARK GREEN <b>EL</b> , FACEPOWDER PINK <b>E8</b> , FANGO <b>E3</b> , GOLDEN YELLOW <b>EO</b> , LIGHT BLUE <b>EO</b> , LIGHT GREY <b>ET</b> , OCEAN BLUE <b>E1</b> , OCHER YELLOW <b>E7</b> , PAPAYA ORANGE <b>EA</b> , PASTEL YELLOW <b>E4</b> , PINE GREEN <b>EJ</b> , RED <b>ER</b> , SAGE GREEN <b>E9</b> |
| <b>FM-M4</b> | Indoor glossy Metal M4 | + 135 € | BLACK NICKEL <b>DZ</b> , CHAMPAGNE GOLD <b>DG</b> , GOLDEN BRONZE <b>DB</b> , MATT BLACK NICKEL <b>DY</b> , MATT GOLDEN BRONZE <b>DC</b> , PINK GOLD <b>DR</b>   |
| <b>ES-1</b>  | Fireproof foam         | + 6 €   | ES-1   |

**Master S**

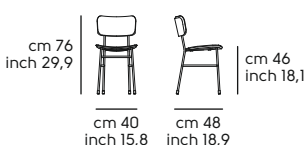

**Master H65**

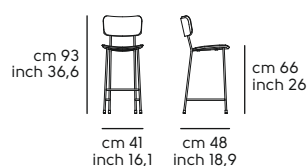

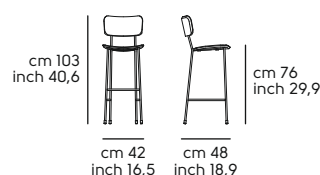

**Master H75**





# Mito design Officina delle Idee

## Mito S, P - Seat fabric or leather, wood, Back in wood legno

Frame in: metal

| Model   | Code    | Mod. | Frame | Seat (Backrest LII) |       |       |       |       |       |       |       |       | Optional                | Q.ty | boxes | Kg | M³   |
|---|---------|------|-------|---------------------|-------|-------|-------|-------|-------|-------|-------|-------|-------------------------|------|-------|----|------|
|   |         |      |       | TA                  | TB    | TC    | TD    | TE    | SF    | SV    | COM   | COL   |                         |      |       |    |      |
| <br> | S1870SD | S    | MI    | 274 €               | 280 € | 294 € | 307 € | 343 € | 311 € | 342 € | 274 € | 294 € | FM-M2<br>FL-I2<br>PD-FO | 2    | 1     | 12 | 0.23 |
|   |         |      |       |                     |       |       |       |       |       |       |       |       |                         |      |       | 4  | 1    |

| Model   | Code    | Mod. | Frame | Seat and Backrest |       | Optional       | Q.ty | boxes | Kg   | M³   |
|---|---------|------|-------|-------------------|-------|----------------|------|-------|------|------|
|   |         |      |       | LII               | L12   |                |      |       |      |      |
| <br> | S1870SW | S    | MI    | 287 €             | 300 € | FM-M2<br>PD-FO | 2    | 1     | 12   | 0.23 |
|   |         |      |       |                   |       |                | 4    | 1     | 25.0 | 0.32 |

### Frame finishes

#### Metal

**MI** WHITE **BB**, BROWN **E6**, SAND **EC**, WHITE PEARL **EF**, GRAPHITE **EG**, BLACK **EN**

### Back finishes

#### Wood

**LII**

Veneered wood painted BLACK **I04**, Veneered wood painted WHITE **I05**, Veneered wood painted CHERRY RED **I09**, Veneered wood painted DARK BROWN **I26**, Veneered wood painted NATURAL **I40**, Veneered wood painted NATURAL OAK **I52**, Veneered wood painted WHITENED **I60**, Veneered wood painted DESERT **I61**, Veneered wood painted LIGHT GREY **I62**, Veneered wood painted DARK GREY **I63**

### Seat and Back finishes

#### Wood

**LII**

Veneered wood painted BLACK **I04**, Veneered wood painted WHITE **I05**, Veneered wood painted CHERRY RED **I09**, Veneered wood painted DARK BROWN **I26**, Veneered wood painted NATURAL **I40**, Veneered wood painted NATURAL OAK **I52**, Veneered wood painted WHITENED **I60**, Veneered wood painted DESERT **I61**, Veneered wood painted LIGHT GREY **I62**, Veneered wood painted DARK GREY **I63**

**L12**

Veneered wood NATURAL OAK **I22**, Veneered wood FLAMED WALNUT **I24**

### Seat finishes

#### Upholstery

|           |   |           |  |
|-----------|---|-----------|--|
| <b>TA</b> | FAUX LEATHER <b>Secret</b> , FABRIC <b>Mirage</b> , FABRIC <b>Cotton Club</b> , FABRIC <b>Renewed Loop</b>  | <b>TB</b> | FAUX LEATHER <b>Vintage</b> , FABRIC <b>Fenix Wool</b> , FABRIC <b>Visual</b> , FABRIC <b>Manhattan</b> , FABRIC <b>Novabuk</b> , FABRIC <b>Network</b> , FABRIC <b>Gyre</b> |
| <b>TC</b> | VELVET SUPERB, FABRIC <b>Second</b> , FABRIC <b>Main Line Flax</b> , FABRIC <b>Oceanic</b> , FABRIC <b>Jumper</b> , FABRIC <b>Flame</b> , FABRIC <b>Ouche</b> , FABRIC <b>Plain</b> , FABRIC <b>Gemma</b> , FABRIC <b>Caltagirone 114</b> | <b>TD</b> | FABRIC <b>Yoredale</b> , FABRIC <b>Remix 3</b>   |
| <b>TE</b> | FABRIC <b>Uniform Melange</b>   | <b>SF</b> | LEATHER <b>Fiore</b>   |
| <b>SV</b> | LEATHER <b>Vintage</b>  |           |  |

**COM/COL - Minimum Q.ty 6 pc. for each material. For weft or patterned fabrics see specific pages**

|  |                        |   |               |
|--|------------------------|---|---------------|
|  | Mtl. 0.45 h. 1.40 Each |  | Mq. 0.68 Each |
|--|------------------------|---|---------------|



| Optionals:   |                          |        |  |
|--------------|--------------------------|--------|--|
|              |                          | Value  | Options/notes  |
| <b>FM-M2</b> | Indoor matt metal M2     | + 48 € | ASH GREY <b>ES</b> , BLUE SAPPHIRE <b>EE</b> , BLUE TURQUOISE <b>EH</b> , BRONZE <b>E2</b> , BULGARO RED <b>FP</b> , CHERRY RED <b>EQ</b> , DARK GREEN <b>EL</b> , FACEPOWDER PINK <b>E8</b> , FANGO <b>E3</b> , GOLDEN YELLOW <b>EO</b> , LIGHT BLUE <b>EO</b> , LIGHT GREY <b>ET</b> , OCEAN BLUE <b>E1</b> , OCHER YELLOW <b>E7</b> , PAPAYA ORANGE <b>EA</b> , PASTEL YELLOW <b>E4</b> , PINE GREEN <b>EJ</b> , RED <b>ER</b> , SAGE GREEN <b>E9</b> |
| <b>FL-I2</b> | Veneered wood finish LI2 | + 8 €  | Veneered wood FLAMED WALNUT <b>I24</b> , Veneered wood NATURAL OAK <b>I22</b>  |
| <b>PD-F0</b> | Felt pad feet            | + 6 €  | PD-F0  |

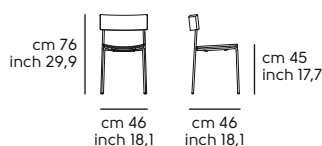

**Mito S**



**Mito H65-75 - Seat fabric or leather, wood, Back in wood legno**

Frame in: metal

| Model  | Code    | Mod. | Frame | Seat (Backrest LI1) |       |       |       |       |       |       |       |       | Optional                | Q.ty   | boxes  | Kg          | M <sup>3</sup> |
|--|---------|------|-------|---------------------|-------|-------|-------|-------|-------|-------|-------|-------|-------------------------|--------|--------|-------------|----------------|
|  |         |      |       | TA                  | TB    | TC    | TD    | TE    | SF    | SV    | COM   | COL   |                         |        |        |             |                |
| <b>Stool MITO H65 M TS-LG</b><br> | S1870HD | H65  | M1    | 336 €               | 345 € | 361 € | 369 € | 406 € | 375 € | 407 € | 336 € | 361 € | FM-M2<br>FL-I2<br>PD-F0 | 1<br>2 | 1<br>1 | 7.7<br>15.4 | 0.28<br>0.31   |
| <b>Stool MITO H75 M TS-LG</b><br> | S1870JD | H75  | M1    | 350 €               | 360 € | 373 € | 385 € | 420 € | 389 € | 420 € | 350 € | 373 € | FM-M2<br>FL-I2<br>PD-F0 | 1<br>2 | 1<br>1 | 8<br>16.0   | 0.30<br>0.34   |

| Model   | Code    | Mod. | Frame | Seat and Backrest |       | Optional       | Q.ty   | boxes  | Kg          | M <sup>3</sup> |
|---|---------|------|-------|-------------------|-------|----------------|--------|--------|-------------|----------------|
|   |         |      |       | LI1               | LI2   |                |        |        |             |                |
| <b>Stool MITO H65 M LG</b><br> | S1870HW | H65  | M1    | 349 €             | 363 € | FM-M2<br>PD-F0 | 1<br>2 | 1<br>1 | 7.7<br>15.4 | 0.28<br>0.31   |
| <b>Stool MITO H75 M LG</b><br> | S1870JW | H75  | M1    | 365 €             | 378 € | FM-M2<br>PD-F0 | 1<br>2 | 1<br>1 | 8<br>16.0   | 0.30<br>0.34   |

**Frame finishes**

|              |   |
|--------------|---|
| <b>Metal</b> |   |
| <b>MI</b>    | WHITE <b>BB</b> , BROWN <b>E6</b> , SAND <b>EC</b> , WHITE PEARL <b>EF</b> , GRAPHITE <b>EG</b> , BLACK <b>EN</b> |

**Back finishes**

|             |  |
|-------------|--|
| <b>Wood</b> |  |
| <b>LII</b>  | Veneered wood painted BLACK <b>I04</b> , Veneered wood painted WHITE <b>I05</b> , Veneered wood painted CHERRY RED <b>I09</b> , Veneered wood painted DARK BROWN <b>I26</b> , Veneered wood painted NATURAL <b>I40</b> , Veneered wood painted NATURAL OAK <b>I52</b> , Veneered wood painted WHITENED <b>I60</b> , Veneered wood painted DESERT <b>I61</b> , Veneered wood painted LIGHT GREY <b>I62</b> , Veneered wood painted DARK GREY <b>I63</b> |



**Seat and Back finishes**

|             |  |
|-------------|--|
| <b>Wood</b> |  |
| <b>LII</b>  | Veneered wood painted BLACK <b>I04</b> , Veneered wood painted WHITE <b>I05</b> , Veneered wood painted CHERRY RED <b>I09</b> , Veneered wood painted DARK BROWN <b>I26</b> , Veneered wood painted NATURAL <b>I40</b> , Veneered wood painted NATURAL OAK <b>I52</b> , Veneered wood painted WHITENED <b>I60</b> , Veneered wood painted DESERT <b>I61</b> , Veneered wood painted LIGHT GREY <b>I62</b> , Veneered wood painted DARK GREY <b>I63</b> |
| <b>L12</b>  | Veneered wood NATURAL OAK <b>I22</b> , Veneered wood FLAMED WALNUT <b>I24</b>  |

**Seat finishes**

|                   |   |
|-------------------|---|
| <b>Upholstery</b> |   |
| <b>TA</b>         | FAUX LEATHER <b>Secret</b> , FABRIC <b>Mirage</b> , FABRIC <b>Cotton Club</b> , FABRIC <b>Renewed Loop</b>  |
| <b>TC</b>         | VELVET SUPERB, FABRIC <b>Second</b> , FABRIC <b>Main Line Flax</b> , FABRIC <b>Oceanic</b> , FABRIC <b>Jumper</b> , FABRIC <b>Flame</b> , FABRIC <b>Ouche</b> , FABRIC <b>Plain</b> , FABRIC <b>Gemma</b> , FABRIC <b>Caltagirone 114</b> |
| <b>TE</b>         | FABRIC <b>Uniform Melange</b>   |
| <b>SV</b>         | LEATHER <b>Vintage</b>  |
| <b>TB</b>         | FAUX LEATHER <b>Vintage</b> , FABRIC <b>Fenix Wool</b> , FABRIC <b>Visual</b> , FABRIC <b>Manhattan</b> , FABRIC <b>Novabuk</b> , FABRIC <b>Network</b> , FABRIC <b>Gyre</b>  |
| <b>TD</b>         | FABRIC <b>Yoredale</b> , FABRIC <b>Remix 3</b>  |
| <b>SF</b>         | LEATHER <b>Fiore</b>  |

**COM/COL - Minimum Q.ty 6 pc. for each material. For weft or patterned fabrics see specific pages**

|   |                        |  |               |
|---|------------------------|--|---------------|
|  <b>COM</b> | Mtl. 0.45 h. 1.40 Each |  <b>COL</b> | Mq. 0.68 Each |
|---|------------------------|--|---------------|

**Optionals:**

|              |                          | Value  | Options/notes  |
|--------------|--------------------------|--------|--|
| <b>FM-M2</b> | Indoor matt metal M2     | + 48 € | ASH GREY <b>ES</b> , BLUE SAPPHIRE <b>EE</b> , BLUE TURQUOISE <b>EH</b> , BRONZE <b>E2</b> , BULGARO RED <b>FP</b> , CHERRY RED <b>EQ</b> , DARK GREEN <b>EL</b> , FACEPOWDER PINK <b>E8</b> , FANGO <b>E3</b> , GOLDEN YELLOW <b>EO</b> , LIGHT BLUE <b>EO</b> , LIGHT GREY <b>ET</b> , OCEAN BLUE <b>E1</b> , OCHER YELLOW <b>E7</b> , PAPAYA ORANGE <b>EA</b> , PASTEL YELLOW <b>E4</b> , PINE GREEN <b>EJ</b> , RED <b>ER</b> , SAGE GREEN <b>E9</b> |
| <b>FL-I2</b> | Veneered wood finish LI2 | + 8 €  | Veneered wood FLAMED WALNUT <b>I24</b> , Veneered wood NATURAL OAK <b>I22</b>  |
| <b>PD-F0</b> | Felt pad feet            | + 6 €  | PD-F0  |

**Mito H65**

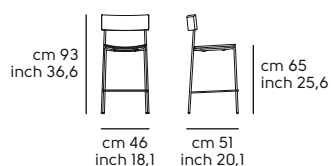



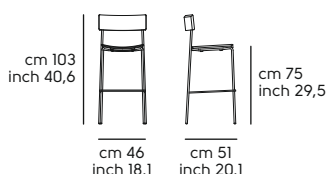



**Mito H75**



# Montera design AtelierNanni







## Montera S - Seat in hide, fabric or leather or wood

Frame and Back in Wood

| Model   | Code    | Mod. | Frame and Backrest | Seat  |       |       |       |       |       |       |       |       |               | Optional      | G.ty | boxes | Kg   | M <sup>3</sup> |
|---|---------|------|--------------------|-------|-------|-------|-------|-------|-------|-------|-------|-------|---------------|---------------|------|-------|------|----------------|
|   |         |      |                    | CU    |       |       |       |       | CT    |       |       |       |               |               |      |       |      |                |
| <br>Chair <b>MONTERA S L CU</b><br>     | S1720SC | S    | LF1                | 414 € |       |       |       |       | 477 € |       |       |       |               | ES-1<br>PD-F0 | 2    | 1     | 12   | 0.45           |
|   |         |      |                    | TA    | TB    | TC    | TD    | TE    | SF    | SV    | COM   | COL   |               |               |      |       |      |                |
| <br>Chair <b>MONTERA S L TS</b><br>     | S1720ST | S    | LF1                | 395 € | 412 € | 433 € | 456 € | 512 € | 446 € | 473 € | 402 € | 433 € | ES-1<br>PD-F0 | 2             | 1    | 12    | 0.45 |                |
|   |         |      |                    | TA    | TB    | TC    | TD    | TE    | SF    | SV    | COM   | COL   |               |               |      |       |      |                |
| <br>Chair <b>MONTERA S L LG</b><br> | S1720SW | S    | LF1                | LF1   |       |       |       |       |       |       |       |       |               | PD-F0         | 2    | 1     | 12   | 0.45           |
|   |         |      |                    | TA    | TB    | TC    | TD    | TE    | SF    | SV    | COM   | COL   |               |               |      |       |      |                |

**Montera H65-75 - Seat in hide, fabric or leather or wood**

Frame in: wood

| Model   | Code    | Mod. | Frame and Backrest | Seat  |       |       |       |       |       |       |       |       | Optional      | Q.ty | boxes | Kg            | M³   |   |   |      |
|---|---------|------|--------------------|-------|-------|-------|-------|-------|-------|-------|-------|-------|---------------|------|-------|---------------|------|---|---|------|
|   |         |      |                    | CU    | CT    |       |       |       |       |       |       |       |               |      |       |               |      |   |   |      |
| <b>Stool MONTERA H65 L CU</b><br>   | SI720HC | H65  | LFI                | 510 € | 590 € |       |       |       |       |       |       |       |               |      |       | ES-1<br>PD-FO | 1    | 1 | 9 | 0.29 |
| <b>Stool MONTERA H75 L CU</b><br>   | SI720JC | H75  | LFI                | 528 € | 607 € |       |       |       |       |       |       |       |               |      |       | ES-1<br>PD-FO | 1    | 1 | 9 | 0.33 |
|   |         |      |                    | TA    | TB    | TC    | TD    | TE    | SF    | SV    | COM   | COL   |               |      |       |               |      |   |   |      |
| <b>Stool MONTERA H65 L TS</b><br>   | SI720HT | H65  | LFI                | 472 € | 485 € | 516 € | 534 € | 591 € | 535 € | 571 € | 482 € | 516 € | ES-1<br>PD-FO | 1    | 1     | 9             | 0.29 |   |   |      |
| <b>Stool MONTERA H75 L TS</b><br> | SI720JT | H75  | LFI                | 487 € | 503 € | 535 € | 549 € | 605 € | 551 € | 589 € | 496 € | 535 € | ES-1<br>PD-FO | 1    | 1     | 9             | 0.33 |   |   |      |
|   |         |      |                    | LFI   |       |       |       |       |       |       |       |       |               |      |       |               |      |   |   |      |
| <b>Stool MONTERA H65 L LG</b><br> | SI720HW | H65  | LFI                | 486 € |       |       |       |       |       |       |       |       | PD-FO         | 1    | 1     | 9             | 0.29 |   |   |      |
| <b>Stool MONTERA H75 L LG</b><br> | SI720JW | H75  | LFI                | 506 € |       |       |       |       |       |       |       |       | PD-FO         | 1    | 1     | 9             | 0.33 |   |   |      |

**Frame and Back finishes**

**Wood**

|            |  |
|------------|--|
| <b>LFI</b> | Ash wood stained BLACK <b>F04</b> , Ash wood stained WHITE <b>F05</b> , Ash wood stained CHERRY RED <b>F09</b> , Ash wood stained FLAMED WALNUT <b>F24</b> , Ash wood stained DARK BROWN <b>F26</b> , Ash wood stained NATURAL <b>F40</b> , Ash wood stained NATURAL OAK <b>F52</b> , Ash wood stained WHITENED <b>F60</b> , Ash wood stained DESERT <b>F61</b> , Ash wood stained LIGHT GREY <b>F62</b> , Ash wood stained DARK GREY <b>F63</b> |
|------------|--|

**Seat finishes**

**Wood**



|            |  |
|------------|--|
| <b>LFI</b> | Ash wood stained BLACK <b>F04</b> , Ash wood stained WHITE <b>F05</b> , Ash wood stained CHERRY RED <b>F09</b> , Ash wood stained FLAMED WALNUT <b>F24</b> , Ash wood stained DARK BROWN <b>F26</b> , Ash wood stained NATURAL <b>F40</b> , Ash wood stained NATURAL OAK <b>F52</b> , Ash wood stained WHITENED <b>F60</b> , Ash wood stained DESERT <b>F61</b> , Ash wood stained LIGHT GREY <b>F62</b> , Ash wood stained DARK GREY <b>F63</b> |
|------------|--|

**Seat finishes**

**Upholstery**

|           |   |           |  |
|-----------|---|-----------|--|
| <b>TA</b> | FAUX LEATHER <b>Secret</b> , FABRIC <b>Mirage</b> , FABRIC <b>Cotton Club</b> , FABRIC <b>Renewed Loop</b>  | <b>TB</b> | FAUX LEATHER <b>Vintage</b> , FABRIC <b>Fenix Wool</b> , FABRIC <b>Visual</b> , FABRIC <b>Manhattan</b> , FABRIC <b>Novabuk</b> , FABRIC <b>Network</b> , FABRIC <b>Gyre</b> |
| <b>TC</b> | VELVET SUPERB, FABRIC <b>Second</b> , FABRIC <b>Main Line Flax</b> , FABRIC <b>Oceanic</b> , FABRIC <b>Jumper</b> , FABRIC <b>Flame</b> , FABRIC <b>Ouche</b> , FABRIC <b>Plain</b> , FABRIC <b>Gemma</b> , FABRIC <b>Caltagirone 114</b> | <b>TD</b> | FABRIC <b>Yoredale</b> , FABRIC <b>Remix 3</b>   |
| <b>TE</b> | FABRIC <b>Uniform Melange</b>   | <b>SF</b> | LEATHER <b>Fiore</b>   |
| <b>SV</b> | LEATHER <b>Vintage</b>  | <b>CU</b> | HIDE   |
| <b>CT</b> | TUSCAN HIDE   |           |  |

**COM/COL - Minimum Q.ty 6 pc. for each material. For weft or patterned fabrics see specific pages**

|  |                        |  |               |
|--|------------------------|--|---------------|
|  <b>COM</b> | Mtl. 0.55 h. 1.40 Each |  <b>COL</b> | Mq. 0.68 Each |
|--|------------------------|--|---------------|

**Optionals:**

|              |                | Value | Options/notes |
|--------------|----------------|-------|---------------|
| <b>ES-1</b>  | Fireproof foam | + 6 € | ES-1          |
| <b>PD-F0</b> | Felt pad feet  | + 6 € | PD-F0         |

**Montera S**

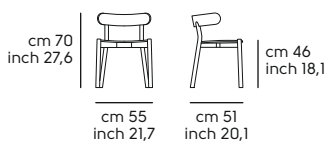

**Montera H65**

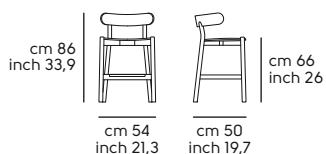

**Montera H75**

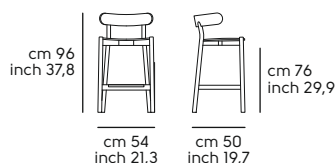



# Mys design Beatriz Sempere

**Mys S, P - Seat and back in fabric or leather**



Frame in: metal

| Model  | Code    | Mod. | Frame | Seat and Backrest |       |       |       |    |       |       |       |       | Optional                         | G.ty | boxes | Kg | M <sup>3</sup> |
|--|---------|------|-------|-------------------|-------|-------|-------|----|-------|-------|-------|-------|----------------------------------|------|-------|----|----------------|
|  |         |      |       | TA                | TB    | TC    | TD    | TE | SF    | SV    | COM   | COL   |                                  |      |       |    |                |
| <br><b>Chair MYS S MTS</b> | S2290S0 | S    | MI    | 499 €             | 524 € | 575 € | 608 € | -- | 596 € | 657 € | 499 € | 575 € | FM-M2<br>FM-M3<br>FM-M4<br>PD-F0 | 2    | 1     | 18 | 0.35           |

**COM/COL - Minimum Q.ty 6 pc. for each material. For weft or patterned fabrics see specific pages**

|  |  |   |    |       |       |       |       |    |       |       |       |       |                                  |   |   |    |      |
|--|--|---|----|-------|-------|-------|-------|----|-------|-------|-------|-------|----------------------------------|---|---|----|------|
| <br>Mtl. 1.46 h. 1.40 Each     | <br>Mq. 1.70 Each |   |    |       |       |       |       |    |       |       |       |       |                                  |   |   |    |      |
| <br><b>Armchair MYS P MTS</b> | S2290P0  | P | MI | 583 € | 617 € | 686 € | 733 € | -- | 716 € | 802 € | 583 € | 686 € | FM-M2<br>FM-M3<br>FM-M4<br>PD-F0 | 1 | 1 | 11 | 0.37 |

**COM/COL - Minimum Q.ty 6 pc. for each material. For weft or patterned fabrics see specific pages**

|  |  |
|--|--|
| <br>Mtl. 2.00 h. 1.40 Each | <br>Mq. 2.70 Each |
|--|--|

**Note:**

TS Front and Back covering available in two-tone or bi-material. Reference price in the upper category

**Frame finishes**

**Metal**

|           |   |
|-----------|---|
| <b>MI</b> | WHITE <b>BB</b> , BROWN <b>E6</b> , SAND <b>EC</b> , WHITE PEARL <b>EF</b> , GRAPHITE <b>EG</b> , BLACK <b>EN</b> |
|-----------|---|

**Seat and Back finishes**

**Upholstery**

|           |   |           |  |
|-----------|---|-----------|--|
| <b>TA</b> | FAUX LEATHER <b>Secret</b> , FABRIC <b>Mirage</b> , FABRIC <b>Cotton Club</b> , FABRIC <b>Renewed Loop</b>  | <b>TB</b> | FAUX LEATHER <b>Vintage</b> , FABRIC <b>Fenix Wool</b> , FABRIC <b>Visual</b> , FABRIC <b>Manhattan</b> , FABRIC <b>Novabuk</b> , FABRIC <b>Network</b> , FABRIC <b>Gyre</b> |
| <b>TC</b> | VELVET SUPERB, FABRIC <b>Second</b> , FABRIC <b>Main Line Flax</b> , FABRIC <b>Oceanic</b> , FABRIC <b>Jumper</b> , FABRIC <b>Flame</b> , FABRIC <b>Ouche</b> , FABRIC <b>Plain</b> , FABRIC <b>Gemma</b> , FABRIC <b>Caltagirone 114</b> | <b>TD</b> | FABRIC <b>Yoredale</b> , FABRIC <b>Remix 3</b>   |
| <b>SF</b> | LEATHER <b>Fiore</b>  | <b>SV</b> | LEATHER <b>Vintage</b>   |

**Optionals:**

|              |                        | Value   | Options/notes  |
|--------------|------------------------|---------|--|
| <b>FM-M2</b> | Indoor matt metal M2   | + 55 €  | ASH GREY <b>ES</b> , BLUE SAPPHIRE <b>EE</b> , BLUE TURQUOISE <b>EH</b> , BRONZE <b>E2</b> , BULGARO RED <b>FP</b> , CHERRY RED <b>EQ</b> , DARK GREEN <b>EL</b> , FACEPOWDER PINK <b>E8</b> , FANGO <b>E3</b> , GOLDEN YELLOW <b>EO</b> , LIGHT BLUE <b>EO</b> , LIGHT GREY <b>ET</b> , OCEAN BLUE <b>EI</b> , OCHER YELLOW <b>E7</b> , PAPAYA ORANGE <b>EA</b> , PASTEL YELLOW <b>E4</b> , PINE GREEN <b>EJ</b> , RED <b>ER</b> , SAGE GREEN <b>E9</b> |
| <b>FM-M3</b> | Indoor glossy metal M3 | + 67 €  | CHROME <b>CC</b>   |
| <b>FM-M4</b> | Indoor glossy Metal M4 | + 110 € | BLACK NICKEL <b>DZ</b> , CHAMPAGNE GOLD <b>DG</b> , GOLDEN BRONZE <b>DB</b> , MATT BLACK NICKEL <b>DY</b> , MATT GOLDEN BRONZE <b>DC</b> , PINK GOLD <b>DR</b>   |
| <b>PD-F0</b> | Felt pad feet          | + 6 €   | PD-F0  |

**Mys S**

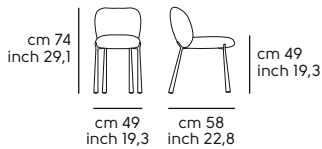

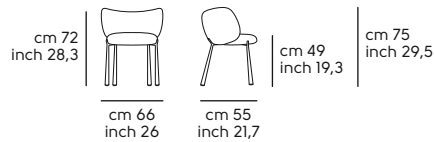

**Mys P**



## Mys H65, H75 - Seat and back in fabric or leather

Frame in: metal

| Model   | Code    | Mod. | Frame | Seat and Backrest |       |       |       |    |       |       |       |       | Optional                         | Q.ty | boxes | Kg   | M³   |
|---|---------|------|-------|-------------------|-------|-------|-------|----|-------|-------|-------|-------|----------------------------------|------|-------|------|------|
|   |         |      |       | TA                | TB    | TC    | TD    | TE | SF    | SV    | COM   | COL   |                                  |      |       |      |      |
| <br><b>Stool MYS H65 M TS</b> | S2290H0 | H65  | MI    | 632 €             | 671 € | 713 € | 748 € | -- | 735 € | 800 € | 632 € | 713 € | FM-M2<br>FM-M3<br>FM-M4<br>PD-F0 | 1    | 1     | 11   | 0.30 |
| <br><b>Stool MYS H75 M TS</b> | S2290J0 | H75  | MI    | 643 €             | 681 € | 724 € | 758 € | -- | 746 € | 810 € | 643 € | 724 € | FM-M2<br>FM-M3<br>FM-M4<br>PD-F0 | 1    | 1     | 11.5 | 0.33 |

COM/COL - Minimum Q.ty 6 pc. for each material. For weft or patterned fabrics see specific pages

|   |   |
|---|---|
|  <b>COM</b><br>Mtl. 1.46 h. 1.40 Each |  <b>COL</b><br>Mq. 1.70 Each |
|---|---|

**Note:**  
TS Front and Back covering available in two-tone or bi-material. Reference price in the upper category

### Frame finishes

| Metal     |   |
|-----------|---|
| <b>MI</b> | WHITE <b>BB</b> , BROWN <b>E6</b> , SAND <b>EC</b> , WHITE PEARL <b>EF</b> , GRAPHITE <b>EG</b> , BLACK <b>EN</b> |

### Seat and Back finishes

| Upholstery |   |
|------------|---|
| <b>TA</b>  | FAUX LEATHER <b>Secret</b> , FABRIC <b>Mirage</b> , FABRIC <b>Cotton Club</b> , FABRIC <b>Renewed Loop</b>  |
| <b>TC</b>  | VELVET SUPERB, FABRIC <b>Second</b> , FABRIC <b>Main Line Flax</b> , FABRIC <b>Oceanic</b> , FABRIC <b>Jumper</b> , FABRIC <b>Flame</b> , FABRIC <b>Ouche</b> , FABRIC <b>Plain</b> , FABRIC <b>Gemma</b> , FABRIC <b>Caltagirone 114</b> |
| <b>SF</b>  | LEATHER <b>Fiore</b>  |
| <b>TB</b>  | FAUX LEATHER <b>Vintage</b> , FABRIC <b>Fenix Wool</b> , FABRIC <b>Visual</b> , FABRIC <b>Manhattan</b> , FABRIC <b>Novabuk</b> , FABRIC <b>Network</b> , FABRIC <b>Gyre</b>  |
| <b>TD</b>  | FABRIC <b>Yoredale</b> , FABRIC <b>Remix 3</b>  |
| <b>SV</b>  | LEATHER <b>Vintage</b>  |

### Optionals:

|              | Value   | Options/notes  |
|--------------|---------|--|
| <b>FM-M2</b> | + 55 €  | ASH GREY <b>ES</b> , BLUE SAPPHIRE <b>EE</b> , BLUE TURQUOISE <b>EH</b> , BRONZE <b>E2</b> , BULGARO RED <b>FP</b> , CHERRY RED <b>EQ</b> , DARK GREEN <b>EL</b> , FACEPOWDER PINK <b>E8</b> , FANGO <b>E3</b> , GOLDEN YELLOW <b>EO</b> , LIGHT BLUE <b>EO</b> , LIGHT GREY <b>ET</b> , OCEAN BLUE <b>E1</b> , OCHER YELLOW <b>E7</b> , PAPAYA ORANGE <b>EA</b> , PASTEL YELLOW <b>E4</b> , PINE GREEN <b>EJ</b> , RED <b>ER</b> , SAGE GREEN <b>E9</b> |
| <b>FM-M3</b> | + 67 €  | CHROME <b>CC</b>   |
| <b>FM-M4</b> | + 110 € | BLACK NICKEL <b>DZ</b> , CHAMPAGNE GOLD <b>DG</b> , GOLDEN BRONZE <b>DB</b> , MATT BLACK NICKEL <b>DY</b> , MATT GOLDEN BRONZE <b>DC</b> , PINK GOLD <b>DR</b>   |
| <b>PD-F0</b> | + 6 €   | PD-F0  |

### Mys H65

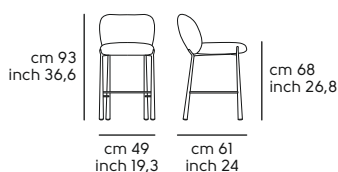

### Mys H75

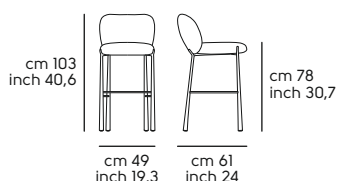

**Mys DP - Seat and back in fabric or leather**

Frame in: metal

| Model   | Code     | Mod. | Frame | Seat and Backrest |       |       |       |    |       |       |       |       | Optional | Q.ty | boxes | Kg | M <sup>2</sup> |
|---|----------|------|-------|-------------------|-------|-------|-------|----|-------|-------|-------|-------|----------|------|-------|----|----------------|
|   |          |      |       | TA                | TB    | TC    | TD    | TE | SF    | SV    | COM   | COL   |          |      |       |    |                |
|  Office Arm. MYS DP TS | S2290DPO | DP   | MI    | 699 €             | 754 € | 811 € | 858 € | -- | 840 € | 927 € | 699 € | 811 € | FM-M2    | 1    | 2     | 14 | 0.29           |

**COM/COL - Minimum Q.ty 6 pc. for each material. For weft or patterned fabrics see specific pages**

|  |   |
|--|---|
|  Mtl. 2.00 h. 1.40 Each |  Mq. 2.70 Each |
|--|---|

**Note:**

TS Front and Back covering available in two-tone or bi-material. Reference price in the upper category

**Frame finishes**

**Metal**

|           |   |
|-----------|---|
| <b>MI</b> | WHITE <b>BB</b> , BROWN <b>E6</b> , SAND <b>EC</b> , WHITE PEARL <b>EF</b> , GRAPHITE <b>EG</b> , BLACK <b>EN</b> |
|-----------|---|

**Seat and Back finishes**

**Upholstery**

|           |   |           |  |
|-----------|---|-----------|--|
| <b>TA</b> | FAUX LEATHER <b>Secret</b> , FABRIC <b>Mirage</b> , FABRIC <b>Cotton Club</b> , FABRIC <b>Renewed Loop</b>  | <b>TB</b> | FAUX LEATHER <b>Vintage</b> , FABRIC <b>Fenix Wool</b> , FABRIC <b>Visual</b> , FABRIC <b>Manhattan</b> , FABRIC <b>Novabuk</b> , FABRIC <b>Network</b> , FABRIC <b>Gyre</b> |
| <b>TC</b> | VELVET SUPERB, FABRIC <b>Second</b> , FABRIC <b>Main Line Flax</b> , FABRIC <b>Oceanic</b> , FABRIC <b>Jumper</b> , FABRIC <b>Flame</b> , FABRIC <b>Ouche</b> , FABRIC <b>Plain</b> , FABRIC <b>Gemma</b> , FABRIC <b>Caltagirone II4</b> | <b>TD</b> | FABRIC <b>Yoredale</b> , FABRIC <b>Remix 3</b>   |
| <b>SF</b> | LEATHER <b>Fiore</b>  | <b>SV</b> | LEATHER <b>Vintage</b>   |

**Optionals:**

|              | Value                          | Options/notes  |
|--------------|--------------------------------|--|
| <b>FM-M2</b> | Indoor matt metal M2<br>+ 55 € | ASH GREY <b>ES</b> , BLUE SAPPHIRE <b>EE</b> , BLUE TURQUOISE <b>EH</b> , BRONZE <b>E2</b> , BULGARO RED <b>FP</b> , CHERRY RED <b>EQ</b> , DARK GREEN <b>EL</b> , FACEPOWDER PINK <b>E8</b> , FANGO <b>E3</b> , GOLDEN YELLOW <b>EO</b> , LIGHT BLUE <b>EO</b> , LIGHT GREY <b>ET</b> , OCEAN BLUE <b>E1</b> , OCHER YELLOW <b>E7</b> , PAPAYA ORANGE <b>EA</b> , PASTEL YELLOW <b>E4</b> , PINE GREEN <b>EJ</b> , RED <b>ER</b> , SAGE GREEN <b>E9</b> |

**Mys DP**

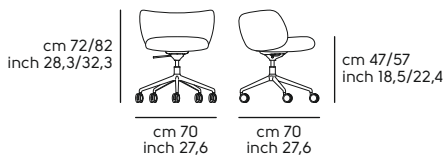

**Mys AP, POUF - Seat and back in fabric or leather**

Frame in: metal



| Model  | Code    | Mod. | Frame | Seat and Backrest |         |         |         |    |         |         |         |         | Optional                         | Q.ty | boxes | Kg | M³   |
|--|---------|------|-------|-------------------|---------|---------|---------|----|---------|---------|---------|---------|----------------------------------|------|-------|----|------|
|  |         |      |       | TA                | TB      | TC      | TD      | TE | SF      | SV      | COM     | COL     |                                  |      |       |    |      |
| <br><b>Waiting Chair MYS AP M TS</b> | S2290AP | AP   | MI    | 1.394 €           | 1.489 € | 1.612 € | 1.712 € | -- | 1.675 € | 1.861 € | 1.394 € | 1.612 € | FM-M2<br>FM-M3<br>FM-M4<br>PD-F0 | 1    | 1     | 27 | 0.62 |
|  |         |      |       |                   |         |         |         |    |         |         |         |         |                                  |      |       |    |      |

**COM/COL - Minimum Q.ty 6 pc. for each material. For weft or patterned fabrics see specific pages**

|   |   |
|---|---|
|  Mtl. 4.15 h. 1.40 Each |  Mq. 6.30 Each |
|---|---|

| Model   | Code    | Mod. | Frame | Seat  |       |       |       |    |       |       |       |       | Optional                         | Q.ty | boxes | Kg   | M³   |
|---|---------|------|-------|-------|-------|-------|-------|----|-------|-------|-------|-------|----------------------------------|------|-------|------|------|
|   |         |      |       | TA    | TB    | TC    | TD    | TE | SF    | SV    | COM   | COL   |                                  |      |       |      |      |
| <br><b>Pouf MYS BI M TS</b> | S2290BI | BI   | MI    | 643 € | 676 € | 711 € | 739 € | -- | 729 € | 782 € | 643 € | 711 € | FM-M2<br>FM-M3<br>FM-M4<br>PD-F0 | 1    | 1     | 12.5 | 0.18 |
|   |         |      |       |       |       |       |       |    |       |       |       |       |                                  |      |       |      |      |

**COM/COL - Minimum Q.ty 6 pc. for each material. For weft or patterned fabrics see specific pages**

|   |   |
|---|---|
|  Mtl. 1.60 h. 1.40 Each |  Mq. 1.90 Each |
|---|---|

**Note:**

TS Front and Back covering available in two-tone or bi-material. Reference price in the upper category

**Frame finishes**

**Metal**

|           |   |
|-----------|---|
| <b>MI</b> | WHITE <b>BB</b> , BROWN <b>E6</b> , SAND <b>EC</b> , WHITE PEARL <b>EF</b> , GRAPHITE <b>EG</b> , BLACK <b>EN</b> |
|-----------|---|

**Seat and Back finishes**

**Upholstery**

|           |   |           |  |
|-----------|---|-----------|--|
| <b>TA</b> | FAUX LEATHER <b>Secret</b> , FABRIC <b>Mirage</b> , FABRIC <b>Cotton Club</b> , FABRIC <b>Renewed Loop</b>  | <b>TB</b> | FAUX LEATHER <b>Vintage</b> , FABRIC <b>Fenix Wool</b> , FABRIC <b>Visual</b> , FABRIC <b>Manhattan</b> , FABRIC <b>Novabuk</b> , FABRIC <b>Network</b> , FABRIC <b>Gyre</b> |
| <b>TC</b> | VELVET SUPERB, FABRIC <b>Second</b> , FABRIC <b>Main Line Flax</b> , FABRIC <b>Oceanic</b> , FABRIC <b>Jumper</b> , FABRIC <b>Flame</b> , FABRIC <b>Ouche</b> , FABRIC <b>Plain</b> , FABRIC <b>Gemma</b> , FABRIC <b>Caltagirone 114</b> | <b>TD</b> | FABRIC <b>Yoredale</b> , FABRIC <b>Remix 3</b>   |
| <b>SF</b> | LEATHER <b>Fiore</b>  | <b>SV</b> | LEATHER <b>Vintage</b>   |

**Optionals:**

|              |                        | Value   | Options/notes  |
|--------------|------------------------|---------|--|
| <b>FM-M2</b> | Indoor matt metal M2   | + 52 €  | ASH GREY <b>ES</b> , BLUE SAPPHIRE <b>EE</b> , BLUE TURQUOISE <b>EH</b> , BRONZE <b>E2</b> , BULGARO RED <b>FP</b> , CHERRY RED <b>EQ</b> , DARK GREEN <b>EL</b> , FACEPOWDER PINK <b>E8</b> , FANGO <b>E3</b> , GOLDEN YELLOW <b>EO</b> , LIGHT BLUE <b>EO</b> , LIGHT GREY <b>ET</b> , OCEAN BLUE <b>EI</b> , OCHER YELLOW <b>E7</b> , PAPAYA ORANGE <b>EA</b> , PASTEL YELLOW <b>E4</b> , PINE GREEN <b>EJ</b> , RED <b>ER</b> , SAGE GREEN <b>E9</b> |
| <b>FM-M3</b> | Indoor glossy metal M3 | + 62 €  | CHROME <b>CC</b>   |
| <b>FM-M4</b> | Indoor glossy Metal M4 | + 104 € | BLACK NICKEL <b>DZ</b> , CHAMPAGNE GOLD <b>DG</b> , GOLDEN BRONZE <b>DB</b> , MATT BLACK NICKEL <b>DY</b> , MATT GOLDEN BRONZE <b>DC</b> , PINK GOLD <b>DR</b>   |
| <b>PD-F0</b> | Felt pad feet          | + 10 €  | PD-F0  |

**Mys AP**

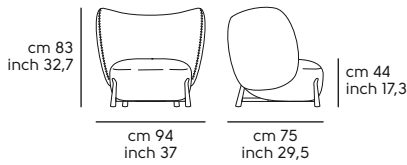

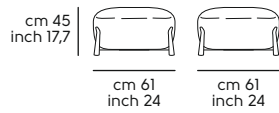

**Mys B1**



# Nenè design Paolo Vernier



## Nenè S PP - Polypropylene

Frame in: polypropylene

| Model  | Code    | Mod. | Frame | Frame | Optional | Q.ty | boxes | Kg   | M³  |
|--|---------|------|-------|-------|----------|------|-------|------|-----|
|  |         |      |       |       | PP1      |      |       |      |     |
| <b>Chair NENÈ.1 S PP</b>   |         |      |       |       |          |      |       |      |     |
|   | S1371SO | S    | PP1   | 130 € | PD-FO    | 4    | 1     | 15.5 | 0.4 |



## Nenè SLG - Wood



Frame in: wood

| Model  | Code    | Mod. | Frame | Frame | Optional | Q.ty | boxes | Kg | M³   |
|--|---------|------|-------|-------|----------|------|-------|----|------|
|  |         |      |       |       | LFI      |      |       |    |      |
| <b>Chair NENÈ SL</b>   |         |      |       |       |          |      |       |    |      |
|   | S1370WL | S    | LFI   | 699 € | PD-FO    | 2    | 1     | 10 | 0.23 |

## Nenè S - Seat and back in hide, fabric or leather

Frame in: polypropylene

| Model  | Code    | Mod. | Frame | Seat and Backrest | Optional | Q.ty | boxes | Kg   | M³  |
|--|---------|------|-------|-------------------|----------|------|-------|------|-----|
|  |         |      |       |                   | CU       |      |       |      |     |
| <b>Chair NENÈ.1 S PP-CU</b>  |         |      |       |                   |          |      |       |      |     |
|   | S1371SC | S    | PP1   | 291 €             | PD-FO    | 4    | 1     | 15.5 | 0.4 |



| Model  | Code    | Mod. | Frame | Seat and Backrest |       |       |       |       |       |       |       |       | Optional      | Q.ty | boxes | Kg | M³  |
|--|---------|------|-------|-------------------|-------|-------|-------|-------|-------|-------|-------|-------|---------------|------|-------|----|-----|
|  |         |      |       | TA                | TB    | TC    | TD    | TE    | SF    | SV    | COM   | COL   |               |      |       |    |     |
| <b>Chair NENÈ.1 S PP-TS</b>  |         |      |       |                   |       |       |       |       |       |       |       |       |               |      |       |    |     |
|   | S1371ST | S    | PP1   | 250 €             | 263 € | 288 € | 305 € | 363 € | 298 € | 340 € | 250 € | 288 € | ES-1<br>PD-FO | 4    | 1     | 18 | 0.4 |



COM/COL - Minimum Q.ty 6 pc. for each material. For weft or patterned fabrics see specific pages

|   |   |
|---|---|
|  Mtl. 0.60 h. 1.40 Each |  Mq. 0.97 Each |
|---|---|

## Nenè P - Seat and back in polypropylene, fabric or leather

Frame in: polypropylene

| Model   | Code    | Mod. | Frame | Frame | Optional | Q.ty | boxes | Kg | M <sup>3</sup> |
|---|---------|------|-------|-------|----------|------|-------|----|----------------|
|   |         |      |       |       | PP1      |      |       |    |                |
| <br><b>Armchair NENÈ.I P PP</b><br> | S1371P0 | P    | PP1   | 149 € | PD-F0    | 4    | 1     | 18 | 0.4            |

| Model  | Code    | Mod. | Frame | Seat and Backrest |       |       |       |       |       |       |       | Optional | Q.ty          | boxes | Kg | M <sup>3</sup> |     |
|--|---------|------|-------|-------------------|-------|-------|-------|-------|-------|-------|-------|----------|---------------|-------|----|----------------|-----|
|  |         |      |       | TA                | TB    | TC    | TD    | TE    | SF    | SV    | COM   | COL      |               |       |    |                |     |
| <br><b>Armchair NENÈ.I P PP-TS</b><br> | S1371PT | P    | PP1   | 261 €             | 276 € | 295 € | 315 € | 371 € | 309 € | 351 € | 261 € | 295 €    | ES-1<br>PD-F0 | 4     | 1  | 18             | 0.4 |

### Frame finishes

#### Polypropylene

|            |  |
|------------|--|
| <b>PP1</b> | WHITE <b>PB4</b> , GRAFITE GREY <b>PGD</b> , SKY GREY <b>PGU</b> , BROWN <b>PM2</b> , BLACK <b>PN4</b> , OCHER YELLOW <b>PO2</b> , RED <b>PRR</b> , RED BULGARO <b>PRS</b> , SAND <b>PS2</b> , TERRACOTTA <b>PT2</b> , DARK GREEN <b>PVL</b> |
|------------|--|

### Seat and Back finishes

#### Upholstery

|           |   |           |  |
|-----------|---|-----------|--|
| <b>TA</b> | FAUX LEATHER <b>Secret</b> , FABRIC <b>Mirage</b> , FABRIC <b>Cotton Club</b> , FABRIC <b>Renewed Loop</b>  | <b>TB</b> | FAUX LEATHER <b>Vintage</b> , FABRIC <b>Fenix Wool</b> , FABRIC <b>Visual</b> , FABRIC <b>Manhattan</b> , FABRIC <b>Novabuk</b> , FABRIC <b>Network</b> , FABRIC <b>Gyre</b> |
| <b>TC</b> | VELVET SUPERB, FABRIC <b>Second</b> , FABRIC <b>Main Line Flax</b> , FABRIC <b>Oceanic</b> , FABRIC <b>Jumper</b> , FABRIC <b>Flame</b> , FABRIC <b>Ouche</b> , FABRIC <b>Plain</b> , FABRIC <b>Gemma</b> , FABRIC <b>Caltagirone 114</b> | <b>TD</b> | FABRIC <b>Yoredale</b> , FABRIC <b>Remix 3</b>   |
| <b>TE</b> | FABRIC <b>Uniform Melange</b>   | <b>SF</b> | LEATHER <b>Fiore</b>   |
| <b>SV</b> | LEATHER <b>Vintage</b>  |           |  |

COM/COL - Minimum Q.ty 6 pc. for each material. For weft or patterned fabrics see specific pages

|            |                        |            |               |
|------------|------------------------|------------|---------------|
| <b>COM</b> | Mtl. 0.60 h. 1.40 Each | <b>COL</b> | Mq. 0.97 Each |
|------------|------------------------|------------|---------------|

#### Optionals:



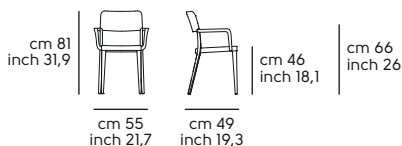

|              |                | Value | Options/notes |
|--------------|----------------|-------|---------------|
| <b>ES-1</b>  | Fireproof foam | + 6 € | ES-1          |
| <b>PD-F0</b> | Felt pad feet  | + 6 € | PD-F0         |



#### Nenè P



**Nenè H65-H75 - Seat and back in polypropylene, fabric or leather**

Frame in: polypropylene

| Model  | Code    | Mod. | Frame | Frame | Optional | Q.ty | boxes | Kg   | M³   |
|--|---------|------|-------|-------|----------|------|-------|------|------|
|  |         |      |       |       | PP1      |      |       |      |      |
| <b>Stool NENÈ.1 H65 PP</b>   |         |      |       |       |          |      |       |      |      |
|   | S1371H0 | H65  | PP1   | 175 € | PD-FO    | 4    | 1     | 17.4 | 0.32 |
| <b>Stool NENÈ.1 H75 PP</b>   |         |      |       |       |          |      |       |      |      |
|   | S1371J0 | H75  | PP1   | 182 € | PD-FO    | 4    | 1     | 18   | 0.37 |

| Model  | Code    | Mod. | Frame | Seat and Backrest |       |       |       |       |       |       |       |       | Optional      | Q.ty | boxes | Kg   | M³   |
|--|---------|------|-------|-------------------|-------|-------|-------|-------|-------|-------|-------|-------|---------------|------|-------|------|------|
|  |         |      |       | TA                | TB    | TC    | TD    | TE    | SF    | SV    | COM   | COL   |               |      |       |      |      |
| <b>Stool NENÈ.1 H65 PP-TS</b>  |         |      |       |                   |       |       |       |       |       |       |       |       |               |      |       |      |      |
|   | S1371HT | H65  | PP1   | 280 €             | 295 € | 314 € | 334 € | 389 € | 327 € | 369 € | 280 € | 314 € | ES-1<br>PD-FO | 4    | 1     | 17.4 | 0.32 |
| <b>Stool NENÈ.1 H75 PP-TS</b>  |         |      |       |                   |       |       |       |       |       |       |       |       |               |      |       |      |      |
|  | S1371JT | H75  | PP1   | 286 €             | 301 € | 320 € | 340 € | 395 € | 333 € | 375 € | 286 € | 320 € | ES-1<br>PD-FO | 4    | 1     | 18   | 0.37 |

**Frame finishes**

**Polypropylene**



|            |  |
|------------|--|
| <b>PPI</b> | WHITE <b>PB4</b> , GRAFITE GREY <b>PGD</b> , SKY GREY <b>PGU</b> , BROWN <b>PM2</b> , BLACK <b>PN4</b> , OCHER YELLOW <b>PO2</b> , RED <b>PRR</b> , RED BULGARO <b>PRS</b> , SAND <b>PS2</b> , TERRACOTTA <b>PT2</b> , DARK GREEN <b>PVL</b> |
|------------|--|

**Seat and Back finishes**

**Upholstery**

|           |   |           |  |
|-----------|---|-----------|--|
| <b>TA</b> | FAUX LEATHER <b>Secret</b> , FABRIC <b>Mirage</b> , FABRIC <b>Cotton Club</b> , FABRIC <b>Renewed Loop</b>  | <b>TB</b> | FAUX LEATHER <b>Vintage</b> , FABRIC <b>Fenix Wool</b> , FABRIC <b>Visual</b> , FABRIC <b>Manhattan</b> , FABRIC <b>Novabuk</b> , FABRIC <b>Network</b> , FABRIC <b>Gyre</b> |
| <b>TC</b> | VELVET SUPERB, FABRIC <b>Second</b> , FABRIC <b>Main Line Flax</b> , FABRIC <b>Oceanic</b> , FABRIC <b>Jumper</b> , FABRIC <b>Flame</b> , FABRIC <b>Ouche</b> , FABRIC <b>Plain</b> , FABRIC <b>Gemma</b> , FABRIC <b>Caltagirone 114</b> | <b>TD</b> | FABRIC <b>Yoredale</b> , FABRIC <b>Remix 3</b>   |
| <b>TE</b> | FABRIC <b>Uniform Melange</b>   | <b>SF</b> | LEATHER <b>Fiore</b>   |
| <b>SV</b> | LEATHER <b>Vintage</b>  |           |  |

**COM/COL - Minimum Q.ty 6 pc. for each material. For weft or patterned fabrics see specific pages**

|   |                        |   |               |
|---|------------------------|---|---------------|
| <b>COM</b><br> | Mtl. 0.46 h. 1.40 Each | <b>COL</b><br> | Mq. 0.84 Each |
|---|------------------------|---|---------------|

**Optionals:**

|              |                | Value | Options/notes |
|--------------|----------------|-------|---------------|
| <b>ES-1</b>  | Fireproof foam | + 6 € | ES-1          |
| <b>PD-F0</b> | Felt pad feet  | + 6 € | PD-F0         |

**Nenè H65**

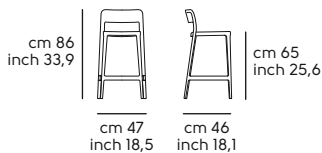

**Nenè H75**

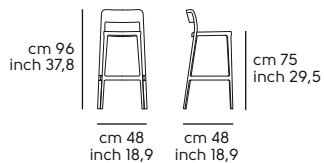

# Nuvola design Officina delle Idee

## Nuvola SB, SBR; SA, SAR - Shell in hide, fabric or leather

Frame in: metal or upholstered

| Model   | Code    | Mod. | Frame | Seat and Backrest | Optional | Q.ty | boxes | Kg   | M <sup>3</sup> |
|---|---------|------|-------|-------------------|----------|------|-------|------|----------------|
| CU  |         |      |       |                   |          |      |       |      |                |
|  Chair NUVOLA SB M CU | S1390MC | SB   | MI    | 414 €             | ES-1     | 2    | 1     | 15.5 | 0.32           |

| Model   | Code    | Mod. | Frame | TA    | TB    | TC    | TD    | TE    | SF    | SV    | COM   | COL   | Optional | Q.ty | boxes | Kg   | M <sup>3</sup> |
|---|---------|------|-------|-------|-------|-------|-------|-------|-------|-------|-------|-------|----------|------|-------|------|----------------|
|  Chair NUVOLA SB M TS | S1390MT | SB   | MI    | 282 € | 322 € | 397 € | 416 € | 468 € | 421 € | 540 € | 282 € | 397 € | ES-1     | 2    | 1     | 15.5 | 0.32           |

COM/COL - Minimum Q.ty 6 pc. for each material. For weft or patterned fabrics see specific pages

|  |                        |   |               |
|--|------------------------|---|---------------|
|  COM | Mtl. 0.75 h. 1.40 Each |  COL | Mq. 1.15 Each |
|--|------------------------|---|---------------|

| Model   | Code    | Mod. | -- | Upholstery | Optional | Q.ty | boxes | Kg   | M <sup>3</sup> |
|---|---------|------|----|------------|----------|------|-------|------|----------------|
| CU  |         |      |    |            |          |      |       |      |                |
|  Chair NUVOLA SB R_CU | S1390SC | SB   |    | 442 €      | ES-1     | 2    | 1     | 15.5 | 0.29           |

| Model   | Code    | Mod. | -- | Upholstery | Optional | Q.ty  | boxes | Kg    | M <sup>3</sup> |       |       |       |      |   |   |      |      |
|---|---------|------|----|------------|----------|-------|-------|-------|----------------|-------|-------|-------|------|---|---|------|------|
| CU  |         |      |    |            |          |       |       |       |                |       |       |       |      |   |   |      |      |
|  Chair NUVOLA SB R_TS | S1390ST | SB   |    | 296 €      | 337 €    | 406 € | 423 € | 518 € | 439 €          | 557 € | 296 € | 406 € | ES-1 | 2 | 1 | 15.5 | 0.29 |



COM/COL - Minimum Q.ty 6 pc. for each material. For weft or patterned fabrics see specific pages

|  |                        |   |               |
|--|------------------------|---|---------------|
|  COM | Mtl. 0.95 h. 1.40 Each |  COL | Mq. 1.50 Each |
|--|------------------------|---|---------------|

| Model  | Code    | Mod. | Frame | Seat and Backrest |  |  |  |  |  |  |  | Optional | Q.ty | boxes | Kg   | M <sup>3</sup> |
|--|---------|------|-------|-------------------|--|--|--|--|--|--|--|----------|------|-------|------|----------------|
| CU   |         |      |       |                   |  |  |  |  |  |  |  |          |      |       |      |                |
| <b>Chair NUVOLA SA M CU</b><br> | S1390RC | SA   | M1    | 430 €             |  |  |  |  |  |  |  | ES-1     | 2    | 1     | 17.5 | 0.36           |

| Model  | Code    | Mod. | Frame | TA    | TB    | TC    | TD    | TE    | SF    | SV    | COM   | COL   | Optional | Q.ty | boxes | Kg   | M <sup>3</sup> |
|--|---------|------|-------|-------|-------|-------|-------|-------|-------|-------|-------|-------|----------|------|-------|------|----------------|
| <b>Chair NUVOLA SA M TS</b><br> | S1390RT | SA   | M1    | 310 € | 349 € | 414 € | 418 € | 496 € | 476 € | 605 € | 310 € | 414 € | ES-1     | 2    | 1     | 17.5 | 0.36           |



**COM/COL - Minimum Q.ty 6 pc. for each material. For weft or patterned fabrics see specific pages**

|  |   |
|--|---|
|  Mtl. 0.80 h. 1.40 Each |  Mq. 1.20 Each |
|--|---|

| Model   | Code    | Mod. | -- | Upholstery |  |  |  |  |  |  |  | Optional | Q.ty | boxes | Kg   | M <sup>3</sup> |
|---|---------|------|----|------------|--|--|--|--|--|--|--|----------|------|-------|------|----------------|
| CU  |         |      |    |            |  |  |  |  |  |  |  |          |      |       |      |                |
| <b>Chair NUVOLA SA R_CU</b><br> | S1390UC | SA   |    | 480 €      |  |  |  |  |  |  |  | ES-1     | 2    | 1     | 17.5 | 0.36           |

| Model  | Code    | Mod. | -- | TA    | TB    | TC    | TD    | TE    | SF    | SV    | COM   | COL   | Optional | Q.ty | boxes | Kg   | M <sup>3</sup> |
|--|---------|------|----|-------|-------|-------|-------|-------|-------|-------|-------|-------|----------|------|-------|------|----------------|
| <b>Chair NUVOLA SA R_TS</b><br> | S1390UT | SA   |    | 327 € | 371 € | 435 € | 457 € | 556 € | 497 € | 634 € | 327 € | 435 € | ES-1     | 2    | 1     | 17.5 | 0.36           |

**COM/COL - Minimum Q.ty 6 pc. for each material. For weft or patterned fabrics see specific pages**

|  |   |
|--|---|
|  Mtl. 1.00 h. 1.40 Each |  Mq. 1.55 Each |
|--|---|

**Note:**

TS Front and Back covering available in two-tone or bi-material. Reference price in the upper category

**Frame finishes**

|              |   |
|--------------|---|
| <b>Metal</b> |   |
| <b>MI</b>    | WHITE <b>BB</b> , BROWN <b>E6</b> , SAND <b>EC</b> , WHITE PEARL <b>EF</b> , GRAPHITE <b>EG</b> , BLACK <b>EN</b> |

**Seat and Back finishes**

|                   |   |           |  |
|-------------------|---|-----------|--|
| <b>Upholstery</b> |   |           |  |
| <b>TA</b>         | FAUX LEATHER <b>Secret</b> , FABRIC <b>Mirage</b> , FABRIC <b>Cotton Club</b> , FABRIC <b>Renewed Loop</b>  | <b>TB</b> | FAUX LEATHER <b>Vintage</b> , FABRIC <b>Fenix Wool</b> , FABRIC <b>Visual</b> , FABRIC <b>Manhattan</b> , FABRIC <b>Novabuk</b> , FABRIC <b>Network</b> , FABRIC <b>Gyre</b> |
| <b>TC</b>         | VELVET SUPERB, FABRIC <b>Second</b> , FABRIC <b>Main Line Flax</b> , FABRIC <b>Oceanic</b> , FABRIC <b>Jumper</b> , FABRIC <b>Flame</b> , FABRIC <b>Ouche</b> , FABRIC <b>Plain</b> , FABRIC <b>Gemma</b> , FABRIC <b>Caltagirone 114</b> | <b>TD</b> | FABRIC <b>Yoredale</b> , FABRIC <b>Remix 3</b>   |
| <b>TE</b>         | FABRIC <b>Uniform Melange</b>   | <b>SF</b> | LEATHER <b>Fiore</b>   |
| <b>SV</b>         | LEATHER <b>Vintage</b>  | <b>CU</b> | HIDE   |

**Options:**

|             |                | Value | Options/notes |
|-------------|----------------|-------|---------------|
| <b>ES-1</b> | Fireproof foam | + 7 € | ES-1          |

**Nuvola SB**

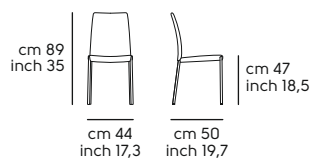

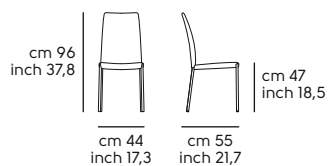

**Nuvola SA**





**Nuvola PBL, PBLR - Shell in hide, fabric or leather**

Frame in: metal or upholstered

| Model  | Code    | Mod. | Frame | Seat and Backrest |  |  |  |  |  |  |  | Optional | Q.ty | boxes | Kg   | M <sup>2</sup> |
|--|---------|------|-------|-------------------|--|--|--|--|--|--|--|----------|------|-------|------|----------------|
| CU   |         |      |       |                   |  |  |  |  |  |  |  |          |      |       |      |                |
|  <b>Armchair NUVOLA PB M CU</b> | S1390QC | PB   | MI    | 649 €             |  |  |  |  |  |  |  | ES-1     | 1    | 1     | 11.5 | 0.28           |

| Model  | Code    | Mod. | Frame | TA    | TB    | TC    | TD    | TE    | SF    | SV    | COM   | COL   | Optional | Q.ty | boxes | Kg   | M <sup>2</sup> |
|--|---------|------|-------|-------|-------|-------|-------|-------|-------|-------|-------|-------|----------|------|-------|------|----------------|
|  <b>Armchair NUVOLA PB M TS</b> | S1390QT | PB   | MI    | 514 € | 557 € | 649 € | 661 € | 775 € | 687 € | 820 € | 514 € | 649 € | ES-1     | 1    | 1     | 11.5 | 0.28           |

**COM/COL - Minimum Q.ty 6 pc. for each material. For weft or patterned fabrics see specific pages**

|  |   |
|--|---|
|  Mtl. 1.35 h. 1.40 Each |  Mq. 2.00 Each |
|--|---|

| Model  | Code    | Mod. | -- | Upholstery |  |  |  |  |  |  |  | Optional | Q.ty | boxes | Kg   | M <sup>2</sup> |
|--|---------|------|----|------------|--|--|--|--|--|--|--|----------|------|-------|------|----------------|
| CU   |         |      |    |            |  |  |  |  |  |  |  |          |      |       |      |                |
|  <b>Armchair NUVOLA PB R CU</b> | S1390PC | PB   |    | 704 €      |  |  |  |  |  |  |  | ES-1     | 1    | 1     | 11.5 | 0.34           |

| Model  | Code    | Mod. | -- | TA    | TB    | TC    | TD    | TE    | SF    | SV    | COM   | COL   | Optional | Q.ty | boxes | Kg   | M <sup>2</sup> |
|--|---------|------|----|-------|-------|-------|-------|-------|-------|-------|-------|-------|----------|------|-------|------|----------------|
|  <b>Armchair NUVOLA PB R TS</b> | S1390PT | PB   |    | 524 € | 590 € | 688 € | 674 € | 786 € | 713 € | 826 € | 524 € | 688 € | ES-1     | 1    | 1     | 11.5 | 0.34           |

**COM/COL - Minimum Q.ty 6 pc. for each material. For weft or patterned fabrics see specific pages**

|  |   |
|--|---|
|  Mtl. 1.60 h. 1.40 Each |  Mq. 2.33 Each |
|--|---|

**Note:**

TS Front and Back covering available in two-tone or bi-material. Reference price in the upper category

**Frame finishes**

|              |   |
|--------------|---|
| <b>Metal</b> |   |
| <b>MI</b>    | WHITE <b>BB</b> , BROWN <b>E6</b> , SAND <b>EC</b> , WHITE PEARL <b>EF</b> , GRAPHITE <b>EG</b> , BLACK <b>EN</b> |

**Seat and Back finishes**

|                   |   |           |  |
|-------------------|---|-----------|--|
| <b>Upholstery</b> |   |           |  |
| <b>TA</b>         | FAUX LEATHER <b>Secret</b> , FABRIC <b>Mirage</b> , FABRIC <b>Cotton Club</b> , FABRIC <b>Renewed Loop</b>  | <b>TB</b> | FAUX LEATHER <b>Vintage</b> , FABRIC <b>Fenix Wool</b> , FABRIC <b>Visual</b> , FABRIC <b>Manhattan</b> , FABRIC <b>Novabuk</b> , FABRIC <b>Network</b> , FABRIC <b>Gyre</b> |
| <b>TC</b>         | VELVET SUPERB, FABRIC <b>Second</b> , FABRIC <b>Main Line Flax</b> , FABRIC <b>Oceanic</b> , FABRIC <b>Jumper</b> , FABRIC <b>Flame</b> , FABRIC <b>Ouche</b> , FABRIC <b>Plain</b> , FABRIC <b>Gemma</b> , FABRIC <b>Caltagirone 114</b> | <b>TD</b> | FABRIC <b>Yoredale</b> , FABRIC <b>Remix 3</b>   |
| <b>TE</b>         | FABRIC <b>Uniform Melange</b>   | <b>SF</b> | LEATHER <b>Fiore</b>   |
| <b>SV</b>         | LEATHER <b>Vintage</b>  | <b>CU</b> | HIDE   |

**Options:**



|             |                | Value | Options/notes |
|-------------|----------------|-------|---------------|
| <b>ES-1</b> | Fireproof foam | + 7 € | ES-1          |

**Nuvola PB**



**Nuvola H65-75 - Shell in hide, fabric or leather**



Frame in: metal or upholstered

| Model  | Code    | Mod. | Frame | Seat and Backrest |  |  |  |  |  |  |  | Optional | Q.ty | boxes | Kg  | M <sup>2</sup> |
|--|---------|------|-------|-------------------|--|--|--|--|--|--|--|----------|------|-------|-----|----------------|
| CU   |         |      |       |                   |  |  |  |  |  |  |  |          |      |       |     |                |
|  <b>Stool NUVOLA H65 M CU</b> | S1390IC | H65  | M1    | 506 €             |  |  |  |  |  |  |  | ES-1     | 1    | 1     | 9   | 0.23           |
|  <b>Stool NUVOLA H75 M CU</b> | S1390KC | H75  | M1    | 519 €             |  |  |  |  |  |  |  | ES-1     | 1    | 1     | 9.5 | 0.23           |

| Model  | Code    | Mod. | Frame | TA    | TB    | TC    | TD    | TE    | SF    | SV    | COM   | COL   | Optional | Q.ty | boxes | Kg  | M <sup>2</sup> |
|--|---------|------|-------|-------|-------|-------|-------|-------|-------|-------|-------|-------|----------|------|-------|-----|----------------|
|  <b>Stool NUVOLA H65 M TS</b>   | S1390IT | H65  | M1    | 383 € | 412 € | 447 € | 472 € | 539 € | 503 € | 573 € | 383 € | 447 € | ES-1     | 1    | 1     | 9   | 0.23           |
|  <b>Stool NUVOLA H75 M TS</b> | S1390KT | H75  | M1    | 398 € | 425 € | 459 € | 485 € | 550 € | 516 € | 586 € | 398 € | 459 € | ES-1     | 1    | 1     | 9.5 | 0.23           |



**COM/COL - Minimum Q.ty 6 pc. for each material. For weft or patterned fabrics see specific pages**

|  |                        |  |               |
|--|------------------------|--|---------------|
|  <b>COM</b> | Mtl. 0.65 h. 1.40 Each |  <b>COL</b> | Mq. 1.00 Each |
|--|------------------------|--|---------------|

| Model  | Code    | Mod. | -- | Upholstery |  |  |  |  |  |  |  | Optional | Q.ty | boxes | Kg  | M <sup>2</sup> |
|--|---------|------|----|------------|--|--|--|--|--|--|--|----------|------|-------|-----|----------------|
| CU   |         |      |    |            |  |  |  |  |  |  |  |          |      |       |     |                |
|  <b>Stool NUVOLA H65 R_CU</b> | S1390HC | H65  |    | 558 €      |  |  |  |  |  |  |  | ES-1     | 1    | 1     | 9   | 0.25           |
|  <b>Stool NUVOLA H75 R_CU</b> | S1390JC | H75  |    | 577 €      |  |  |  |  |  |  |  | ES-1     | 1    | 1     | 9.5 | 0.27           |

| Model  | Code    | Mod. | -- | TA    | TB    | TC    | TD    | TE    | SF    | SV    | COM   | COL   | Optional | Q.ty | boxes | Kg  | M <sup>2</sup> |
|--|---------|------|----|-------|-------|-------|-------|-------|-------|-------|-------|-------|----------|------|-------|-----|----------------|
|  <b>Stool NUVOLA H65 R_TS</b> | S1390HT | H65  |    | 405 € | 437 € | 487 € | 495 € | 561 € | 524 € | 605 € | 405 € | 487 € | ES-1     | 1    | 1     | 9   | 0.25           |
|  <b>Stool NUVOLA H75 R_TS</b> | S1390JT | H75  |    | 422 € | 456 € | 505 € | 515 € | 579 € | 543 € | 626 € | 422 € | 505 € | ES-1     | 1    | 1     | 9.5 | 0.27           |

**COM/COL - Minimum Q.ty 6 pc. for each material. For weft or patterned fabrics see specific pages**

|   |   |
|---|---|
| <p><b>COM</b><br/> Mtl. 0.95 h. 1.40 Each</p> | <p><b>COL</b><br/> Mq. 1.50 Each</p> |
|---|---|

**Note:**  
TS Front and Back covering available in two-tone or bi-material. Reference price in the upper category

**Frame finishes**

**Metal**

|           |   |
|-----------|---|
| <b>MI</b> | WHITE <b>BB</b> , BROWN <b>E6</b> , SAND <b>EC</b> , WHITE PEARL <b>EF</b> , GRAPHITE <b>EG</b> , BLACK <b>EN</b> |
|-----------|---|

**Seat and Back finishes**

**Upholstery**

|           |   |           |  |
|-----------|---|-----------|--|
| <b>TA</b> | FAUX LEATHER <b>Secret</b> , FABRIC <b>Mirage</b> , FABRIC <b>Cotton Club</b> , FABRIC <b>Renewed Loop</b>  | <b>TB</b> | FAUX LEATHER <b>Vintage</b> , FABRIC <b>Fenix Wool</b> , FABRIC <b>Visual</b> , FABRIC <b>Manhattan</b> , FABRIC <b>Novabuk</b> , FABRIC <b>Network</b> , FABRIC <b>Gyre</b> |
| <b>TC</b> | VELVET SUPERB, FABRIC <b>Second</b> , FABRIC <b>Main Line Flax</b> , FABRIC <b>Oceanic</b> , FABRIC <b>Jumper</b> , FABRIC <b>Flame</b> , FABRIC <b>Ouche</b> , FABRIC <b>Plain</b> , FABRIC <b>Gemma</b> , FABRIC <b>Caltagirone 114</b> | <b>TD</b> | FABRIC <b>Yoredale</b> , FABRIC <b>Remix 3</b>   |
| <b>TE</b> | FABRIC <b>Uniform Melange</b>   | <b>SF</b> | LEATHER <b>Fiore</b>   |
| <b>SV</b> | LEATHER <b>Vintage</b>  | <b>CU</b> | HIDE   |

**Optionals:**

|             | Value          | Options/notes |
|-------------|----------------|---------------|
| <b>ES-1</b> | Fireproof foam | + 6 € ES-1    |

**Nuvola H65**

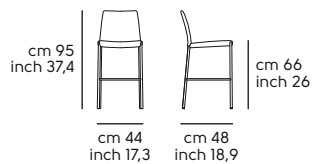



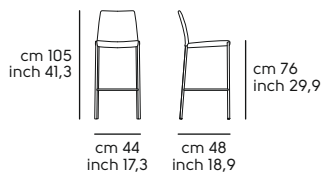











**Nuvola H75**



# Ola design Paolo Vernier

## Ola S, P, H65-75, BN - Metal Shell









Frame in: metal

| Model   | Code    | Mod. | -- | Frame and Shell |       |       |       | Optional | G.ty   | boxes  | Kg           | M <sup>3</sup> |
|---|---------|------|----|-----------------|-------|-------|-------|----------|--------|--------|--------------|----------------|
|   |         |      |    | M1              | M2    | O1    | O2    |          |        |        |              |                |
| <b>Chair OLA S M</b><br>  O1-O2<br> x4         | S1401S0 | S    |    | 156 €           | 210 € | 269 € | 322 € | PD-F0    | 2<br>4 | 1<br>1 | 14<br>26.0   | 0.31<br>0.41   |
| <b>Armchair OLA P M</b><br>  O1-O2<br> x4      | S1401P0 | P    |    | 182 €           | 239 € | 294 € | 352 € | PD-F0    | 2<br>4 | 1<br>1 | 14.5<br>27.0 | 0.32<br>0.42   |
| <b>Stool OLA H65 M</b><br>  O1-O2<br> x4     | S1401H0 | H65  |    | 192 €           | 243 € | 306 € | 356 € | PD-F0    | 1<br>2 | 1<br>1 | 9<br>16.0    | 0.28<br>0.34   |
| <b>Stool OLA H75 M</b><br>  O1-O2<br> x4 | S1401J0 | H75  |    | 205 €           | 256 € | 317 € | 368 € | PD-F0    | 1<br>2 | 1<br>1 | 9<br>16.0    | 0.28<br>0.34   |
| <b>Bench OLA BN M</b><br>  O1-O2<br> x4  | S1401B1 | BN   |    | 371 €           | 452 € | 485 € | 565 € | PD-F0    | 1      | 1      | 14           | 0.56           |

**Note:**  
OUTDOOR USE SEASIDE EXCLUDED

## Ola S, P, H65-75 - Inox

Frame and shell in: Inox

| Model  | Code    | Mod. | -- | Frame and Shell |       | Optional | Q.ty<br> | boxes<br> | Kg<br>       | M³<br>       |
|--|---------|------|----|-----------------|-------|----------|----------|-----------|--------------|--------------|
|  |         |      |    | M1              | M2    |          |          |           |              |              |
| <b>Chair OLA S M INOX</b><br>    | S140IS1 | S    |    | 280 €           | 321 € |          | 2<br>4   | 1<br>1    | 14<br>26.0   | 0.31<br>0.41 |
|                                 |         |      |    |                 |       |          |          |           |              |              |
| <b>Armchair OLA P M INOX</b><br> | S140IP1 | P    |    | 310 €           | 352 € |          | 2<br>4   | 1<br>1    | 14.5<br>27.0 | 0.32<br>0.42 |
|                                 |         |      |    |                 |       |          |          |           |              |              |
| <b>Stool OLA H65 M INOX</b><br>  | S140IH1 | H65  |    | 342 €           | 384 € |          | 1<br>2   | 1<br>1    | 9<br>16.0    | 0.28<br>0.34 |
|                                 |         |      |    |                 |       |          |          |           |              |              |
| <b>Stool OLA H75 M INOX</b><br> | S140IJ1 | H75  |    | 353 €           | 394 € |          | 1<br>2   | 1<br>1    | 9<br>16.0    | 0.28<br>0.34 |
|                                |         |      |    |                 |       |          |          |           |              |              |

### Frame and shell finishes

#### Metal

|           |  |
|-----------|--|
| <b>M1</b> | WHITE <b>BB</b> , BROWN <b>E6</b> , SAND <b>EC</b> , WHITE PEARL <b>EF</b> , GRAPHITE <b>EG</b> , BLACK <b>EN</b>  |
| <b>M2</b> | LIGHT BLUE <b>E0</b> , OCEAN BLUE <b>E1</b> , BRONZE <b>E2</b> , FANGO <b>E3</b> , PASTEL YELLOW <b>E4</b> , OCHER YELLOW <b>E7</b> , FACEPOWDER PINK <b>E8</b> , SAGE GREEN <b>E9</b> , PAPAYA ORANGE <b>EA</b> , BLUE SAPPHIRE <b>EE</b> , BLUE TURQUOISE <b>EH</b> , PINE GREEN <b>EJ</b> , DARK GREEN <b>EL</b> , GOLDEN YELLOW <b>EO</b> , CHERRY RED <b>EQ</b> , RED <b>ER</b> , ASH GREY <b>ES</b> , LIGHT GREY <b>ET</b> , BULGARO RED <b>FP</b> |

#### Metal Outdoor

|           |   |
|-----------|---|
| <b>O1</b> | Outdoor WHITE <b>BB</b> , Outdoor BROWN <b>E6</b> , Outdoor SAND <b>EC</b> , Outdoor WHITE PEARL <b>EF</b> , Outdoor GRAFITE <b>EG</b> , Outdoor BLACK <b>EN</b>  |
| <b>O2</b> | Outdoor LIGHT BLUE <b>E0</b> , Outdoor OCEAN BLUE <b>E1</b> , Outdoor BRONZE <b>E2</b> , Outdoor FANGO <b>E3</b> , Outdoor PASTEL YELLOW <b>E4</b> , Outdoor OCHER YELLOW <b>E7</b> , Outdoor FACEPOWDER PINK <b>E8</b> , Outdoor SAGE GREEN <b>E9</b> , Outdoor .ALUMINIUM <b>AA</b> , Outdoor BLUE SAPPHIRE <b>EE</b> , Outdoor BLUE TURQUOISE <b>EH</b> , Outdoor PINE GREEN <b>EJ</b> , Outdoor DARK GREEN <b>EL</b> , Outdoor GOLD YELLOW <b>EO</b> , Outdoor CHERRY RED <b>EQ</b> , Outdoor RED <b>ER</b> , Outdoor ASH GREY <b>ES</b> , Outdoor LIGHT GREY <b>ET</b> , Outdoor RED BULGARO <b>FP</b> |

#### Optionals:

|              | Value         | Options/notes |
|--------------|---------------|---------------|
| <b>PD-F0</b> | Felt pad feet | + 6 € PD-F0   |

#### Ola S

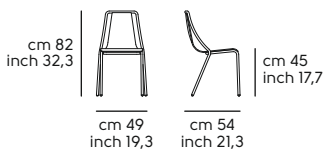

#### Ola P

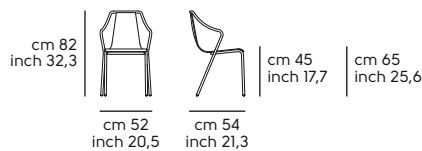

#### Ola H65

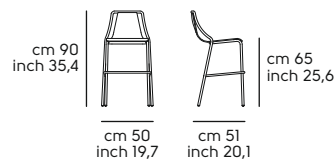

#### Ola H75

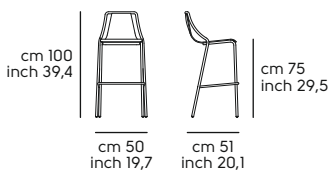



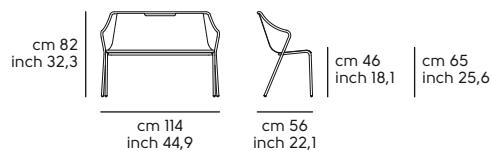



#### Ola BN



# Ola S, P, H65-75 - Wood shell

Frame in: metal

| Model   | Code    | Mod. | Frame | Shell |       | Optional       | Q.ty   | boxes  | Kg           | M³           |
|---|---------|------|-------|-------|-------|----------------|--------|--------|--------------|--------------|
|   |         |      |       | L11   | L12   |                |        |        |              |              |
| <b>Chair OLA S M LG</b><br>    | S1400SW | S    | M1    | 242 € | 257 € | FM-M2<br>PD-F0 | 2<br>4 | 1<br>1 | 14<br>26.0   | 0.31         |
| <br>CATAS EN 1728              |         |      |       |       |       |                |        |        |              | 0.41         |
| <b>Armchair OLA P M LG</b><br> | S1400PW | P    | M1    | 270 € | 284 € | FM-M2<br>PD-F0 | 2<br>4 | 1<br>1 | 14.5<br>27.0 | 0.32<br>0.42 |
| <b>Stool OLA H65 M LG</b><br>  | S1400HW | H65  | M1    | 283 € | 292 € | FM-M2<br>PD-F0 | 1<br>2 | 1<br>1 | 9<br>16.0    | 0.26         |
|                                |         |      |       |       |       |                |        |        |              | 0.29         |
| <b>Stool OLA H75 M LG</b><br> | S1400JW | H75  | M1    | 295 € | 306 € | FM-M2<br>PD-F0 | 1<br>2 | 1<br>1 | 9<br>16.0    | 0.30<br>0.35 |
|                              |         |      |       |       |       |                |        |        |              |              |

### Frame finishes

#### Metal

**M1** WHITE **BB**, INDUSTRIAL **E5**, BROWN **E6**, SAND **EC**, WHITE PEARL **EF**, GRAPHITE **EG**, BLACK **EN**

### Shell finishes

#### Wood

**L11** Veneered wood painted BLACK **I04**, Veneered wood painted WHITE **I05**, Veneered wood painted CHERRY RED **I09**, Veneered wood painted DARK BROWN **I26**, Veneered wood painted NATURAL **I40**, Veneered wood painted NATURAL OAK **I52**, Veneered wood painted WHITENED **I60**, Veneered wood painted DESERT **I61**, Veneered wood painted LIGHT GREY **I62**, Veneered wood painted DARK GREY **I63**

**L12** Veneered wood NATURAL OAK **I22**, Veneered wood FLAMED WALNUT **I24**

### Optionals:

|              |                      | Value  | Options/notes  |
|--------------|----------------------|--------|--|
| <b>FM-M2</b> | Indoor matt metal M2 | + 48 € | ASH GREY <b>ES</b> , BLUE SAPPHIRE <b>EE</b> , BLUE TURQUOISE <b>EH</b> , BRONZE <b>E2</b> , BULGARO RED <b>FP</b> , CHERRY RED <b>EQ</b> , DARK GREEN <b>EL</b> , FACEPOWDER PINK <b>E8</b> , FANGO <b>E3</b> , GOLDEN YELLOW <b>EO</b> , LIGHT BLUE <b>EO</b> , LIGHT GREY <b>ET</b> , OCEAN BLUE <b>E1</b> , OCHER YELLOW <b>E7</b> , PAPAYA ORANGE <b>EA</b> , PASTEL YELLOW <b>E4</b> , PINE GREEN <b>EJ</b> , RED <b>ER</b> , SAGE GREEN <b>E9</b> |
| <b>PD-F0</b> | Felt pad feet        | + 6 €  | PD-F0  |

### Ola S

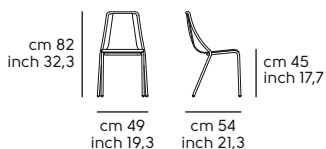

### Ola P

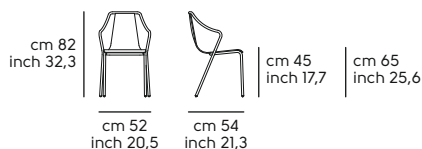

### Ola H65

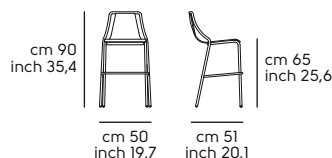



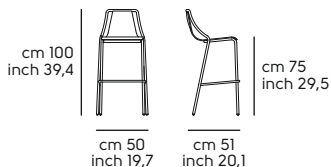





### Ola H75



## Ola S, P, H65-75 - Shell in hide

Frame in: metal

| Model  | Code    | Mod. | Frame | Shell |       | Optional       | Q.ty   | boxes  | Kg           | M³           |
|--|---------|------|-------|-------|-------|----------------|--------|--------|--------------|--------------|
|  |         |      |       | CU    | CT    |                |        |        |              |              |
| <b>Chair OLA S M CU</b><br>    | S1400SC | S    | MI    | 307 € | 432 € | FM-M2<br>PD-F0 | 2<br>4 | 1<br>1 | 14<br>26.0   | 0.31<br>0.41 |
|                               |         |      |       |       |       |                |        |        |              |              |
| <b>Armchair OLA P M CU</b><br> | S1400PC | P    | MI    | 334 € | 460 € | FM-M2<br>PD-F0 | 2<br>4 | 1<br>1 | 14.5<br>27.0 | 0.32<br>0.42 |
|                               |         |      |       |       |       |                |        |        |              |              |
| <b>Stool OLA H65 M CU</b><br>  | S1400HC | H65  | MI    | 338 € | 439 € | FM-M2<br>PD-F0 | 1<br>2 | 1<br>1 | 9<br>16.0    | 0.26<br>0.3  |
|                               |         |      |       |       |       |                |        |        |              |              |
| <b>Stool OLA H75 M CU</b><br> | S1400JC | H75  | MI    | 352 € | 451 € | FM-M2<br>PD-F0 | 1<br>2 | 1<br>1 | 9<br>16.0    | 0.28<br>0.34 |
|                             |         |      |       |       |       |                |        |        |              |              |

### Frame finishes

#### Metal

**MI** WHITE **BB**, INDUSTRIAL **E5**, BROWN **E6**, SAND **EC**, WHITE PEARL **EF**, GRAPHITE **EG**, BLACK **EN**

### Shell finishes

#### Upholstery

**CU** HIDE

**CT** TUSCAN HIDE

### Optionals:

|              |                      | Value  | Options/notes  |
|--------------|----------------------|--------|--|
| <b>FM-M2</b> | Indoor matt metal M2 | + 48 € | ASH GREY <b>ES</b> , BLUE SAPPHIRE <b>EE</b> , BLUE TURQUOISE <b>EH</b> , BRONZE <b>E2</b> , BULGARO RED <b>FP</b> , CHERRY RED <b>EQ</b> , DARK GREEN <b>EL</b> , FACEPOWDER PINK <b>E8</b> , FANGO <b>E3</b> , GOLDEN YELLOW <b>EO</b> , LIGHT BLUE <b>EO</b> , LIGHT GREY <b>ET</b> , OCEAN BLUE <b>E1</b> , OCHER YELLOW <b>E7</b> , PAPAYA ORANGE <b>EA</b> , PASTEL YELLOW <b>E4</b> , PINE GREEN <b>EJ</b> , RED <b>ER</b> , SAGE GREEN <b>E9</b> |
| <b>PD-F0</b> | Felt pad feet        | + 6 €  | PD-F0  |

### Ola S

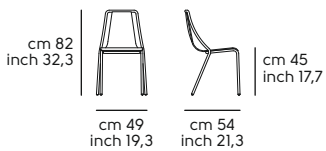

### Ola P

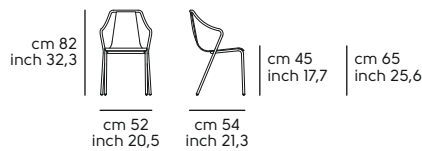

### Ola H65

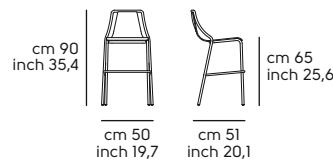



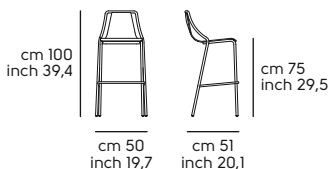

### Ola H75





**Ola S, P, H65-75 - Shell in fabric or leather**

Frame in: metal



| Model   | Code    | Mod. | Frame | Shell |       |       |       |       |       |       |       |       | Optional       | Q.ty   | boxes  | Kg           | M <sup>2</sup> |
|---|---------|------|-------|-------|-------|-------|-------|-------|-------|-------|-------|-------|----------------|--------|--------|--------------|----------------|
|   |         |      |       | TA    | TB    | TC    | TD    | TE    | SF    | SV    | COM   | COL   |                |        |        |              |                |
| <b>Chair OLA S M TS</b><br> <br> | S1400ST | S    | M1    | 236 € | 260 € | 291 € | 308 € | 364 € | 322 € | 387 € | 236 € | 291 € | FM-M2<br>PD-F0 | 2<br>4 | 1<br>1 | 14<br>26.0   | 0.31<br>0.41   |
| <b>Armchair OLA P M TS</b><br>    | S1400PT | P    | M1    | 264 € | 288 € | 321 € | 339 € | 391 € | 349 € | 416 € | 264 € | 321 € | FM-M2<br>PD-F0 | 2<br>4 | 1<br>1 | 14.5<br>27.0 | 0.32<br>0.42   |

**COM/COL - Minimum Q.ty 6 pc. for each material. For weft or patterned fabrics see specific pages**

|  |   |
|--|---|
|  Mtl. 0.65 h. 1.40 Each |  Mq. 1.07 Each |
|--|---|

| Model  | Code    | Mod. | Frame | Shell |       |       |       |       |       |       |       |       | Optional       | Q.ty   | boxes  | Kg        | M <sup>2</sup> |
|--|---------|------|-------|-------|-------|-------|-------|-------|-------|-------|-------|-------|----------------|--------|--------|-----------|----------------|
|  |         |      |       | TA    | TB    | TC    | TD    | TE    | SF    | SV    | COM   | COL   |                |        |        |           |                |
| <b>Stool OLA H65 M TS</b><br>   | S1400HT | H65  | M1    | 285 € | 312 € | 336 € | 353 € | 408 € | 364 € | 428 € | 285 € | 336 € | FM-M2<br>PD-F0 | 1<br>2 | 1<br>1 | 9<br>16.0 | 0.26<br>0.32   |
| <b>Stool OLA H75 M TS</b><br>  | S1400JT | H75  | M1    | 300 € | 326 € | 349 € | 367 € | 420 € | 376 € | 440 € | 300 € | 349 € | FM-M2<br>PD-F0 | 1<br>2 | 1<br>1 | 9<br>16.0 | 0.30<br>0.35   |

**COM/COL - Minimum Q.ty 6 pc. for each material. For weft or patterned fabrics see specific pages**

|  |   |
|--|---|
|  Mtl. 0.60 h. 1.40 Each |  Mq. 0.95 Each |
|--|---|

**Note:**

TS Front and Back covering available in two-tone or bi-material. Reference price in the upper category

**Frame finishes**

|              |  |
|--------------|--|
| <b>Metal</b> |  |
| <b>MI</b>    | WHITE <b>BB</b> , INDUSTRIAL <b>E5</b> , BROWN <b>E6</b> , SAND <b>EC</b> , WHITE PEARL <b>EF</b> , GRAPHITE <b>EG</b> , BLACK <b>EN</b> |

**Shell finishes**

|                   |   |           |  |
|-------------------|---|-----------|--|
| <b>Upholstery</b> |   |           |  |
| <b>TA</b>         | FAUX LEATHER <b>Secret</b> , FABRIC <b>Mirage</b> , FABRIC <b>Cotton Club</b> , FABRIC <b>Renewed Loop</b>  | <b>TB</b> | FAUX LEATHER <b>Vintage</b> , FABRIC <b>Fenix Wool</b> , FABRIC <b>Visual</b> , FABRIC <b>Manhattan</b> , FABRIC <b>Novabuk</b> , FABRIC <b>Network</b> , FABRIC <b>Gyre</b> |
| <b>TC</b>         | VELVET SUPERB, FABRIC <b>Second</b> , FABRIC <b>Main Line Flax</b> , FABRIC <b>Oceanic</b> , FABRIC <b>Jumper</b> , FABRIC <b>Flame</b> , FABRIC <b>Ouche</b> , FABRIC <b>Plain</b> , FABRIC <b>Gemma</b> , FABRIC <b>Caltagirone 114</b> | <b>TD</b> | FABRIC <b>Yoredale</b> , FABRIC <b>Remix 3</b>   |
| <b>TE</b>         | FABRIC <b>Uniform Melange</b>   | <b>SF</b> | LEATHER <b>Fiore</b>   |
| <b>SV</b>         | LEATHER <b>Vintage</b>  |           |  |

**Optionals:**

|              | Value  | Options/notes  |
|--------------|--------|--|
| <b>FM-M2</b> | + 48 € | ASH GREY <b>ES</b> , BLUE SAPPHIRE <b>EE</b> , BLUE TURQUOISE <b>EH</b> , BRONZE <b>E2</b> , BULGARO RED <b>FP</b> , CHERRY RED <b>EQ</b> , DARK GREEN <b>EL</b> , FACEPOWDER PINK <b>E8</b> , FANGO <b>E3</b> , GOLDEN YELLOW <b>EO</b> , LIGHT BLUE <b>EO</b> , LIGHT GREY <b>ET</b> , OCEAN BLUE <b>E1</b> , OCHER YELLOW <b>E7</b> , PAPAYA ORANGE <b>EA</b> , PASTEL YELLOW <b>E4</b> , PINE GREEN <b>EJ</b> , RED <b>ER</b> , SAGE GREEN <b>E9</b> |
| <b>PD-F0</b> | + 6 €  | PD-F0  |

**Ola S**

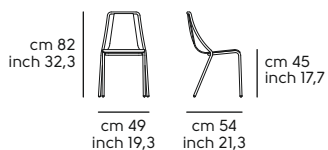

**Ola P**

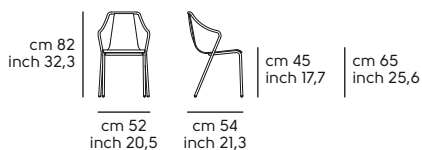

**Ola H65**

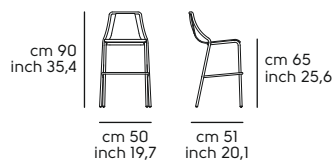

**Ola H75**

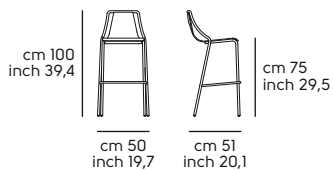



# Oslo design Franco Poli



## Oslo P - Seat in fabric, leather or hide

Frame in: ashwood or walnut

| Model   | Code    | Mod. | Frame | Seat  |       |       |       |       |       |       |       |       | Optional       | Q.ty | boxes | Kg | M³   |
|---|---------|------|-------|-------|-------|-------|-------|-------|-------|-------|-------|-------|----------------|------|-------|----|------|
|   |         |      |       | TA    | TB    | TC    | TD    | TE    | SF    | SV    | COM   | COL   |                |      |       |    |      |
|  <b>Armchair OSLO P L TS</b> | S2280PT | P    | LF1   | 795 € | 810 € | 825 € | 835 € | 902 € | 844 € | 868 € | 795 € | 825 € | FL-F3<br>PD-F0 | 2    | 1     | 14 | 0.36 |

COM/COL - Minimum Q.ty 6 pc. for each material. For weft or patterned fabrics see specific pages

|  |                        |  |               |
|--|------------------------|--|---------------|
|  <b>COM</b> | Mtl. 0.73 h. 1.40 Each |  <b>COL</b> | Mq. 0.84 Each |
|--|------------------------|--|---------------|

| Model   | Code    | Mod. | Frame | Seat  |         | Optional       | Q.ty | boxes | Kg | M³   |
|---|---------|------|-------|-------|---------|----------------|------|-------|----|------|
|   |         |      |       | CK    | CT      |                |      |       |    |      |
|  <b>Armchair OSLO P L CU</b>    | S2280PC | P    | LF1   | 919 € | 964 €   | FL-F3<br>PD-F0 | 2    | 1     | 14 | 0.36 |
|  <b>Armchair OSLO P L CU-X</b> | S2280PI | P    | LF1   | 997 € | 1.041 € | FL-F3<br>PD-F0 | 2    | 1     | 14 | 0.36 |

**Frame and Back finishes**

**Wood**

|            |  |
|------------|--|
| <b>LFI</b> | Ash wood stained BLACK <b>F04</b> , Ash wood stained WHITE <b>F05</b> , Ash wood stained CHERRY RED <b>F09</b> , Ash wood stained FLAMED WALNUT <b>F24</b> , Ash wood stained DARK BROWN <b>F26</b> , Ash wood stained NATURAL <b>F40</b> , Ash wood stained NATURAL OAK <b>F52</b> , Ash wood stained WHITENED <b>F60</b> , Ash wood stained DESERT <b>F61</b> , Ash wood stained LIGHT GREY <b>F62</b> , Ash wood stained DARK GREY <b>F63</b> |
|------------|--|

**Seat finishes**

**Upholstery**

|           |   |           |  |
|-----------|---|-----------|--|
| <b>TA</b> | FAUX LEATHER <b>Secret</b> , FABRIC <b>Mirage</b> , FABRIC <b>Cotton Club</b> , FABRIC <b>Renewed Loop</b>  | <b>TB</b> | FAUX LEATHER <b>Vintage</b> , FABRIC <b>Fenix Wool</b> , FABRIC <b>Visual</b> , FABRIC <b>Manhattan</b> , FABRIC <b>Novabuk</b> , FABRIC <b>Network</b> , FABRIC <b>Gyre</b> |
| <b>TC</b> | VELVET SUPERB, FABRIC <b>Second</b> , FABRIC <b>Main Line Flax</b> , FABRIC <b>Oceanic</b> , FABRIC <b>Jumper</b> , FABRIC <b>Flame</b> , FABRIC <b>Ouche</b> , FABRIC <b>Plain</b> , FABRIC <b>Gemma</b> , FABRIC <b>Caltagirone 114</b> | <b>TD</b> | FABRIC <b>Yoredale</b> , FABRIC <b>Remix 3</b>   |
| <b>TE</b> | FABRIC <b>Uniform Melange</b>   | <b>SF</b> | LEATHER <b>Fiore</b>   |
| <b>SV</b> | LEATHER <b>Vintage</b>  | <b>CK</b> | HIDE_TK  |
| <b>CT</b> | TUSCAN HIDE   |           |  |

**Optionals:**

|              |                    | Value   | Options/notes             |
|--------------|--------------------|---------|---------------------------|
| <b>FL-F3</b> | Walnut Natural LF3 | + 323 € | Walnut NATURAL <b>N40</b> |
| <b>PD-F0</b> | Felt pad feet      | + 6 €   | PD-F0                     |

**Oslo P TS**

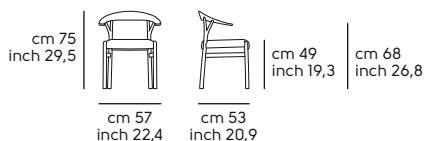



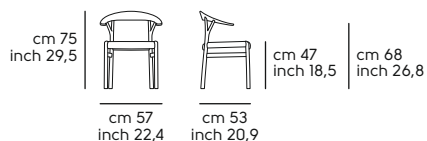

**Oslo P CU**



# P47 design Franco Poli

## Armchair P47 P - Shell in hide seat in fabric or leather

Frame in: metal

| Model   | Code     | Mod.   | Frame | Seat (Backrest Hide CK) |         |         |         |         |         |         |         |         | Optional                         | G.ty   | boxes  | Kg         | M³           |
|---|----------|--------|-------|-------------------------|---------|---------|---------|---------|---------|---------|---------|---------|----------------------------------|--------|--------|------------|--------------|
|   |          |        |       | TA                      | TB      | TC      | TD      | TE      | SF      | SV      | COM     | COL     |                                  |        |        |            |              |
| <b>Armchair P47 P M TS_CU</b><br>                  | S2140P00 | P M    | M1    | 813 €                   | 829 €   | 843 €   | 881 €   | 942 €   | 864 €   | 885 €   | 813 €   | 843 €   | FM-M2<br>FM-M3<br>FM-M4<br>RV-CT | 1<br>2 | 1<br>1 | 13<br>24.0 | 0.37<br>0.37 |
| <b>Armchair P47 P GX TS_CU</b><br>                 | S2140PX0 | P GX   | M1    | 973 €                   | 988 €   | 1.004 € | 1.041 € | 1.102 € | 1.024 € | 1.045 € | 973 €   | 1.004 € | FM-M2<br>RV-CT                   | 1      | 1      | 17         | 0.24         |
| <b>Armch. with self-return P47 P GX TS_CU</b><br> | S2140PX1 | P GX A | M1    | 996 €                   | 1.010 € | 1.026 € | 1.062 € | 1.124 € | 1.048 € | 1.068 € | 996 €   | 1.026 € | FM-M2<br>RV-CT                   | 1      | 1      | 17         | 0.24         |
| <b>Office Arm. P47 DP TS_CU</b><br>              | S2140DP0 | DP     | M1    | 1.000 €                 | 1.015 € | 1.031 € | 1.068 € | 1.128 € | 1.052 € | 1.072 € | 1.000 € | 1.031 € | FM-M2<br>RV-CT                   | 1      | 2      | 19         | 0.31         |
| <b>Office Arm. P47 DPA TS_CU</b><br>             | S2140DPA | DPA    | M1    | 1.122 €                 | 1.136 € | 1.152 € | 1.189 € | 1.250 € | 1.172 € | 1.194 € | 1.122 € | 1.152 € | FM-M2<br>RV-CT                   | 1      | 2      | 20         | 0.44         |

Note:

**Frame finishes**

|              |   |
|--------------|---|
| <b>Metal</b> |   |
| <b>MI</b>    | WHITE <b>BB</b> , BROWN <b>E6</b> , SAND <b>EC</b> , WHITE PEARL <b>EF</b> , GRAPHITE <b>EG</b> , BLACK <b>EN</b> |



**Back finishes**

|                   |         |
|-------------------|---------|
| <b>Upholstery</b> |         |
| <b>CK</b>         | HIDE_TK |



**Seat finishes**

|                   |   |
|-------------------|---|
| <b>Upholstery</b> |   |
| <b>TA</b>         | FAUX LEATHER <b>Secret</b> , FABRIC <b>Mirage</b> , FABRIC <b>Cotton Club</b> , FABRIC <b>Renewed Loop</b>  |
| <b>TC</b>         | VELVET SUPERB, FABRIC <b>Second</b> , FABRIC <b>Main Line Flax</b> , FABRIC <b>Oceanic</b> , FABRIC <b>Jumper</b> , FABRIC <b>Flame</b> , FABRIC <b>Ouche</b> , FABRIC <b>Plain</b> , FABRIC <b>Gemma</b> , FABRIC <b>Caltagirone 114</b> |
| <b>TE</b>         | FABRIC <b>Uniform Melange</b>   |
| <b>SV</b>         | LEATHER <b>Vintage</b>  |
| <b>TB</b>         | FAUX LEATHER <b>Vintage</b> , FABRIC <b>Fenix Wool</b> , FABRIC <b>Visual</b> , FABRIC <b>Manhattan</b> , FABRIC <b>Novabuk</b> , FABRIC <b>Network</b> , FABRIC <b>Gyre</b>  |
| <b>TD</b>         | FABRIC <b>Yoredale</b> , FABRIC <b>Remix 3</b>  |
| <b>SF</b>         | LEATHER <b>Fiore</b>  |

**COM/COL Seat - Minimum Q.ty 6 pc. for each material. For weft or patterned fabrics see specific pages**

|   |                        |  |               |
|---|------------------------|--|---------------|
|  <b>COM</b> | Mtl. 0.40 h. 1.40 Each |  <b>COL</b> | Mq. 0.57 Each |
|---|------------------------|--|---------------|

**COM/COL - Minimum Q.ty 6 pc. for each material. For weft or patterned fabrics see specific pages**

|   |                        |  |               |
|---|------------------------|--|---------------|
|  <b>COM</b> | Mtl. 0.75 h. 1.40 Each |  <b>COL</b> | Mq. 1.12 Each |
|---|------------------------|--|---------------|

**Optionals:**

|              | Value   | Options/notes  |
|--------------|---------|--|
| <b>FM-M2</b> | + 61 €  | ASH GREY <b>ES</b> , BLUE SAPPHIRE <b>EE</b> , BLUE TURQUOISE <b>EH</b> , BRONZE <b>E2</b> , BULGARO RED <b>FP</b> , CHERRY RED <b>EQ</b> , DARK GREEN <b>EL</b> , FACEPOWDER PINK <b>E8</b> , FANGO <b>E3</b> , GOLDEN YELLOW <b>EO</b> , LIGHT BLUE <b>EO</b> , LIGHT GREY <b>ET</b> , OCEAN BLUE <b>EI</b> , OCHER YELLOW <b>E7</b> , PAPAYA ORANGE <b>EA</b> , PASTEL YELLOW <b>E4</b> , PINE GREEN <b>EJ</b> , RED <b>ER</b> , SAGE GREEN <b>E9</b> |
| <b>FM-M3</b> | + 31 €  | CHROME <b>CC</b>   |
| <b>FM-M4</b> | + 165 € | BLACK NICKEL <b>DZ</b> , CHAMPAGNE GOLD <b>DG</b> , GOLDEN BRONZE <b>DB</b> , MATT BLACK NICKEL <b>DY</b> , MATT GOLDEN BRONZE <b>DC</b> , PINK GOLD <b>DR</b>   |
| <b>RV-CT</b> | + 196 € | TUSCAN HIDE  |

**P47 P M**

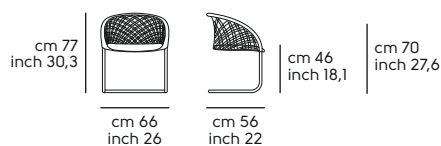

**P47 P GX**

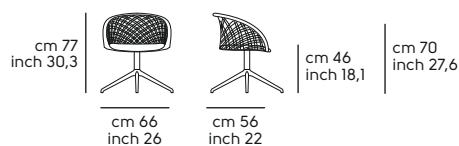

**P47 P GX A**

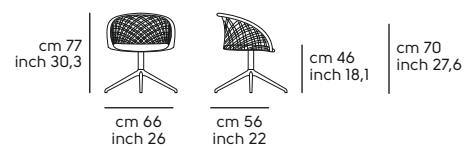

**P47 DP**

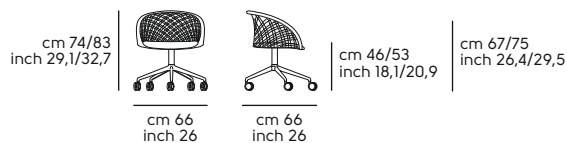

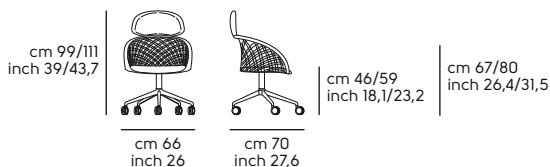

**P47 DPA**



**Waiting Chair P47 AP - Shell in hide seat in fabric or leather**

Frame in: metal

| Model   | Code     | Mod.   | Frame | Seat (Backrest Hide CK) |         |         |         |         |         |         |         |         | Optional                | Q.ty | boxes | Kg   | M <sup>3</sup> |
|---|----------|--------|-------|-------------------------|---------|---------|---------|---------|---------|---------|---------|---------|-------------------------|------|-------|------|----------------|
|   |          |        |       | TA                      | TB      | TC      | TD      | TE      | SF      | SV      | COM     | COL     |                         |      |       |      |                |
|  <p><b>Waiting Chair P47 AP MTS_CU</b></p>   | S2140APO | AP M   | M1    | 1.034 €                 | 1.060 € | 1.097 € | 1.146 € | 1.221 € | 1.120 € | 1.168 € | 1.034 € | 1.097 € | FM-M2<br>FM-M3<br>RV-CT | 1    | 1     | 17.5 | 0.46           |
|  <p><b>Waiting Chair P47 AP GXTS_CU</b></p>  | S2140APX | AP GX  | M1    | 1.209 €                 | 1.236 € | 1.273 € | 1.321 € | 1.396 € | 1.294 € | 1.343 € | 1.209 € | 1.273 € | FM-M2<br>RV-CT          | 1    | 1     | 20   | 0.50           |
|  <p><b>Waiting Chair P47 APA GXTS_CU</b></p> | S2140APY | APA GX | M1    | 1.368 €                 | 1.395 € | 1.431 € | 1.479 € | 1.553 € | 1.452 € | 1.500 € | 1.368 € | 1.431 € | FM-M2<br>RV-CT          | 1    | 1     | 21   | 0.68           |

**Note:**

**Frame finishes**

|              |   |
|--------------|---|
| <b>Metal</b> |   |
| <b>MI</b>    | WHITE <b>BB</b> , BROWN <b>E6</b> , SAND <b>EC</b> , WHITE PEARL <b>EF</b> , GRAPHITE <b>EG</b> , BLACK <b>EN</b> |



**Back finishes**

|                   |         |
|-------------------|---------|
| <b>Upholstery</b> |         |
| <b>CK</b>         | HIDE_TK |



**Seat finishes**

|                   |   |
|-------------------|---|
| <b>Upholstery</b> |   |
| <b>TA</b>         | FAUX LEATHER <b>Secret</b> , FABRIC <b>Mirage</b> , FABRIC <b>Cotton Club</b> , FABRIC <b>Renewed Loop</b>  |
| <b>TC</b>         | VELVET SUPERB, FABRIC <b>Second</b> , FABRIC <b>Main Line Flax</b> , FABRIC <b>Oceanic</b> , FABRIC <b>Jumper</b> , FABRIC <b>Flame</b> , FABRIC <b>Ouche</b> , FABRIC <b>Plain</b> , FABRIC <b>Gemma</b> , FABRIC <b>Caltagirone 114</b> |
| <b>TE</b>         | FABRIC <b>Uniform Melange</b>   |
| <b>SV</b>         | LEATHER <b>Vintage</b>  |
| <b>TB</b>         | FAUX LEATHER <b>Vintage</b> , FABRIC <b>Fenix Wool</b> , FABRIC <b>Visual</b> , FABRIC <b>Manhattan</b> , FABRIC <b>Novabuk</b> , FABRIC <b>Network</b> , FABRIC <b>Gyre</b>  |
| <b>TD</b>         | FABRIC <b>Yoredale</b> , FABRIC <b>Remix 3</b>  |
| <b>SF</b>         | LEATHER <b>Fiore</b>  |

**COM/COL Seat - Minimum Q.ty 6 pc. for each material. For weft or patterned fabrics see specific pages**

|   |   |
|---|---|
|  Mtl. 0.65 h. 1.40 Each |  Mq. 0.79 Each |
|---|---|

**COM/COL - Minimum Q.ty 6 pc. for each material. For weft or patterned fabrics see specific pages**

|   |   |
|---|---|
|  Mtl. 1.00 h. 1.40 Each |  Mq. 1.38 Each |
|---|---|

**Optionals:**

|              | Value   | Options/notes  |
|--------------|---------|--|
| <b>FM-M2</b> | + 61 €  | ASH GREY <b>ES</b> , BLUE SAPPHIRE <b>EE</b> , BLUE TURQUOISE <b>EH</b> , BRONZE <b>E2</b> , BULGARO RED <b>FP</b> , CHERRY RED <b>EQ</b> , DARK GREEN <b>EL</b> , FACEPOWDER PINK <b>E8</b> , FANGO <b>E3</b> , GOLDEN YELLOW <b>EO</b> , LIGHT BLUE <b>ED</b> , LIGHT GREY <b>ET</b> , OCEAN BLUE <b>E1</b> , OCHER YELLOW <b>E7</b> , PAPAYA ORANGE <b>EA</b> , PASTEL YELLOW <b>E4</b> , PINE GREEN <b>EJ</b> , RED <b>ER</b> , SAGE GREEN <b>E9</b> |
| <b>FM-M3</b> | + 31 €  | CHROME <b>CC</b>   |
| <b>RV-CT</b> | + 268 € | TUSCAN HIDE  |

**P47AP M**

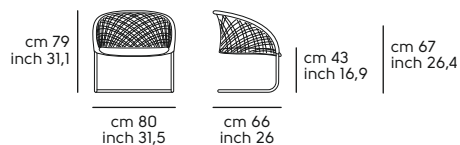

**P47AP GX**

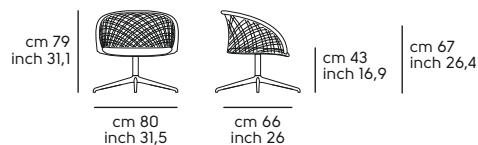

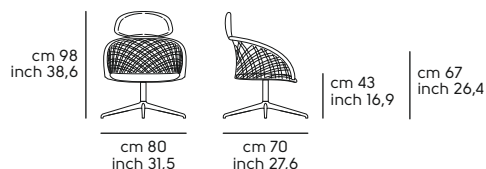

**P47APA GX**



**Stool P47 H65-H75 - Shell in hide seat in fabric or leather**

Frame in: metal

| Model  | Code     | Mod.  | Frame | Seat (Backrest Hide CK) |       |       |       |       |       |       |       |       | Optional                         | Q.ty | boxes | Kg | M <sup>2</sup> |
|--|----------|-------|-------|-------------------------|-------|-------|-------|-------|-------|-------|-------|-------|----------------------------------|------|-------|----|----------------|
|  |          |       |       | TA                      | TB    | TC    | TD    | TE    | SF    | SV    | COM   | COL   |                                  |      |       |    |                |
|  <b>Stool P47 H65 M TS_CU</b> | S2140H00 | H65 M | MI    | 835 €                   | 849 € | 863 € | 896 € | 964 € | 885 € | 904 € | 835 € | 863 € | FM-M2<br>FM-M3<br>FM-M4<br>RV-CT | 1    | 1     | 12 | 0.30           |
|  <b>Stool P47 H75 M TS_CU</b> | S2140J00 | H75 M | MI    | 849 €                   | 860 € | 874 € | 909 € | 977 € | 895 € | 916 € | 849 € | 874 € | FM-M2<br>FM-M3<br>FM-M4<br>RV-CT | 1    | 1     | 13 | 0.33           |

Note:

**Frame finishes**

**Metal**

**MI** WHITE **BB**, BROWN **E6**, SAND **EC**, WHITE PEARL **EF**, GRAPHITE **EG**, BLACK **EN**

**Back finishes**

**Upholstery**



**CK** HIDE\_TK

**Seat finishes**

**Upholstery**

|           |   |           |  |
|-----------|---|-----------|--|
| <b>TA</b> | FAUX LEATHER <b>Secret</b> , FABRIC <b>Mirage</b> , FABRIC <b>Cotton Club</b> , FABRIC <b>Renewed Loop</b>  | <b>TB</b> | FAUX LEATHER <b>Vintage</b> , FABRIC <b>Fenix Wool</b> , FABRIC <b>Visual</b> , FABRIC <b>Manhattan</b> , FABRIC <b>Novabuk</b> , FABRIC <b>Network</b> , FABRIC <b>Gyre</b> |
| <b>TC</b> | VELVET SUPERB, FABRIC <b>Second</b> , FABRIC <b>Main Line Flax</b> , FABRIC <b>Oceanic</b> , FABRIC <b>Jumper</b> , FABRIC <b>Flame</b> , FABRIC <b>Ouche</b> , FABRIC <b>Plain</b> , FABRIC <b>Gemma</b> , FABRIC <b>Caltagirone 114</b> | <b>TD</b> | FABRIC <b>Yoredale</b> , FABRIC <b>Remix 3</b>   |
| <b>TE</b> | FABRIC <b>Uniform Melange</b>   | <b>SF</b> | LEATHER <b>Fiore</b>   |
| <b>SV</b> | LEATHER <b>Vintage</b>  |           |  |

**COM/COL Seat - Minimum Q.ty 6 pc. for each material. For weft or patterned fabrics see specific pages**

|  |                        |  |               |
|--|------------------------|--|---------------|
|  <b>COM</b> | Mtl. 0.30 h. 1.40 Each |  <b>COL</b> | Mq. 0.55 Each |
|--|------------------------|--|---------------|

**Optionals:**

|              | Value                  | Options/notes |
|--------------|------------------------|---------------|
| <b>FM-M2</b> | Indoor matt metal M2   | + 61 €        |
| <b>FM-M3</b> | Indoor glossy metal M3 | + 31 €        |
| <b>FM-M4</b> | Indoor glossy Metal M4 | + 164 €       |
| <b>RV-CT</b> | Tuscan hide upholstery | + 177 €       |

ASH GREY **ES**, BLUE SAPPHIRE **EE**, BLUE TURQUOISE **EH**, BRONZE **E2**, BULGARO RED **FP**, CHERRY RED **EQ**, DARK GREEN **EL**, FACEPOWDER PINK **E8**, FANGO **E3**, GOLDEN YELLOW **EO**, LIGHT BLUE **EO**, LIGHT GREY **ET**, OCEAN BLUE **EI**, OCHER YELLOW **E7**, PAPAYA ORANGE **EA**, PASTEL YELLOW **E4**, PINE GREEN **EJ**, RED **ER**, SAGE GREEN **E9**

CHROME **CC**

BLACK NICKEL **DZ**, CHAMPAGNE GOLD **DG**, GOLDEN BRONZE **DB**, MATT BLACK NICKEL **DY**, MATT GOLDEN BRONZE **DC**, PINK GOLD **DR**

TUSCAN HIDE

**P47 H65 M**

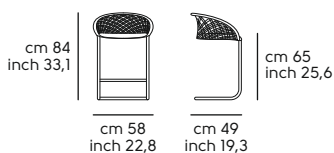

**P47 H75 M**

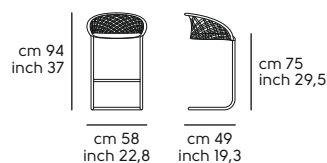

### Stool P47 SG - Shell in hide seat in fabric or leather

Frame in: metal

| Model  | Code     | Mod. | Frame | Seat (Backrest Hide CK) |         |         |         |         |         |         |         |         | Optional       | Q.ty | boxes | Kg | M³   |
|--|----------|------|-------|-------------------------|---------|---------|---------|---------|---------|---------|---------|---------|----------------|------|-------|----|------|
|  |          |      |       | TA                      | TB      | TC      | TD      | TE      | SF      | SV      | COM     | COL     |                |      |       |    |      |
|  <b>Stool P47 SG TS_CU</b> | S2140ZT0 | SG   | MI    | 1.003 €                 | 1.015 € | 1.030 € | 1.063 € | 1.131 € | 1.051 € | 1.071 € | 1.003 € | 1.030 € | FM-M2<br>RV-CT | 1    | 1     | 22 | 0.32 |

Note:

#### Frame finishes

##### Metal

**MI** WHITE **BB**, BROWN **E6**, SAND **EC**, WHITE PEARL **EF**, GRAPHITE **EG**, BLACK **EN**

#### Back finishes

##### Upholstery

**CK** HIDE\_TK



#### Seat finishes

##### Upholstery

|           |   |
|-----------|---|
| <b>TA</b> | FAUX LEATHER <b>Secret</b> , FABRIC <b>Mirage</b> , FABRIC <b>Cotton Club</b> , FABRIC <b>Renewed Loop</b>  |
| <b>TC</b> | VELVET SUPERB, FABRIC <b>Second</b> , FABRIC <b>Main Line Flax</b> , FABRIC <b>Oceanic</b> , FABRIC <b>Jumper</b> , FABRIC <b>Flame</b> , FABRIC <b>Ouche</b> , FABRIC <b>Plain</b> , FABRIC <b>Gemma</b> , FABRIC <b>Caltagirone 114</b> |
| <b>TE</b> | FABRIC <b>Uniform Melange</b>   |
| <b>SV</b> | LEATHER <b>Vintage</b>  |

|           |  |
|-----------|--|
| <b>TB</b> | FAUX LEATHER <b>Vintage</b> , FABRIC <b>Fenix Wool</b> , FABRIC <b>Visual</b> , FABRIC <b>Manhattan</b> , FABRIC <b>Novabuk</b> , FABRIC <b>Network</b> , FABRIC <b>Gyre</b> |
| <b>TD</b> | FABRIC <b>Yoredale</b> , FABRIC <b>Remix 3</b>   |
| <b>SF</b> | LEATHER <b>Fiore</b>   |

COM/COL Seat - Minimum Q.ty 6 pc. for each material. For weft or patterned fabrics see specific pages

|   |                        |  |               |
|---|------------------------|--|---------------|
|  <b>COM</b> | Mtl. 0.30 h. 1.40 Each |  <b>COL</b> | Mq. 0.55 Each |
|---|------------------------|--|---------------|

#### Optionals:

|              |                        | Value   | Options/notes  |
|--------------|------------------------|---------|--|
| <b>FM-M2</b> | Indoor matt metal M2   | + 61 €  | ASH GREY <b>ES</b> , BLUE SAPPHIRE <b>EE</b> , BLUE TURQUOISE <b>EH</b> , BRONZE <b>E2</b> , BULGARO RED <b>FP</b> , CHERRY RED <b>EQ</b> , DARK GREEN <b>EL</b> , FACEPOWDER PINK <b>E8</b> , FANGO <b>E3</b> , GOLDEN YELLOW <b>EO</b> , LIGHT BLUE <b>EO</b> , LIGHT GREY <b>ET</b> , OCEAN BLUE <b>EI</b> , OCHER YELLOW <b>E7</b> , PAPAYA ORANGE <b>EA</b> , PASTEL YELLOW <b>E4</b> , PINE GREEN <b>EJ</b> , RED <b>ER</b> , SAGE GREEN <b>E9</b> |
| <b>RV-CT</b> | Tuscan hide upholstery | + 177 € | TUSCAN HIDE  |

#### P47 SG

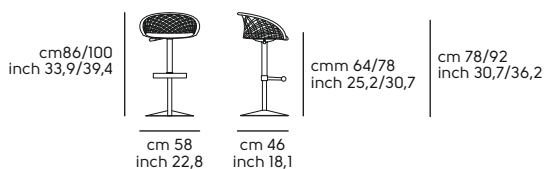

**Pouf P47 B2 - Cushion in fabric or leather**

Frame in: metal

| Model   | Code     | Mod. | Frame | Cushion |       |       |       |       |       |       |       |       | Optional | Q.ty | boxes | Kg | M <sup>2</sup> |
|---|----------|------|-------|---------|-------|-------|-------|-------|-------|-------|-------|-------|----------|------|-------|----|----------------|
|   |          |      |       | TA      | TB    | TC    | TD    | TE    | SF    | SV    | COM   | COL   |          |      |       |    |                |
| <br><b>Pouf P47 B2 MTS</b> | S2140B20 | B2   | M1    | 534 €   | 562 € | 598 € | 647 € | 714 € | 620 € | 668 € | 534 € | 598 € | FM-M2    | 1    | 1     | 12 | 0.20           |

Note:

**Frame finishes**

**Metal**



|           |   |
|-----------|---|
| <b>M1</b> | WHITE <b>BB</b> , BROWN <b>E6</b> , SAND <b>EC</b> , WHITE PEARL <b>EF</b> , GRAPHITE <b>EG</b> , BLACK <b>EN</b> |
|-----------|---|

**Seat finishes**

**Upholstery**

|           |   |           |  |
|-----------|---|-----------|--|
| <b>TA</b> | FAUX LEATHER <b>Secret</b> , FABRIC <b>Mirage</b> , FABRIC <b>Cotton Club</b> , FABRIC <b>Renewed Loop</b>  | <b>TB</b> | FAUX LEATHER <b>Vintage</b> , FABRIC <b>Fenix Wool</b> , FABRIC <b>Visual</b> , FABRIC <b>Manhattan</b> , FABRIC <b>Novabuk</b> , FABRIC <b>Network</b> , FABRIC <b>Gyre</b> |
| <b>TC</b> | VELVET SUPERB, FABRIC <b>Second</b> , FABRIC <b>Main Line Flax</b> , FABRIC <b>Oceanic</b> , FABRIC <b>Jumper</b> , FABRIC <b>Flame</b> , FABRIC <b>Ouche</b> , FABRIC <b>Plain</b> , FABRIC <b>Gemma</b> , FABRIC <b>Caltagirone 114</b> | <b>TD</b> | FABRIC <b>Yoredale</b> , FABRIC <b>Remix 3</b>   |
| <b>TE</b> | FABRIC <b>Uniform Melange</b>   | <b>SF</b> | LEATHER <b>Fiore</b>   |
| <b>SV</b> | LEATHER <b>Vintage</b>  |           |  |

**COM/COL Seat - Minimum Q.ty 6 pc. for each material. For weft or patterned fabrics see specific pages**

|  |                        |  |               |
|--|------------------------|--|---------------|
|  <b>COM</b> | Mtl. 0.65 h. 1.40 Each |  <b>COL</b> | Mq. 1.42 Each |
|--|------------------------|--|---------------|

**Optionals:**

|              | Value                | Options/notes  |
|--------------|----------------------|--|
| <b>FM-M2</b> | Indoor matt metal M2 | + 61 €<br>ASH GREY <b>ES</b> , BLUE SAPPHIRE <b>EE</b> , BLUE TURQUOISE <b>EH</b> , BRONZE <b>E2</b> , BULGARO RED <b>FP</b> , CHERRY RED <b>EQ</b> , DARK GREEN <b>EL</b> , FACEPOWDER PINK <b>E8</b> , FANGO <b>E3</b> , GOLDEN YELLOW <b>EO</b> , LIGHT BLUE <b>EO</b> , LIGHT GREY <b>ET</b> , OCEAN BLUE <b>EI</b> , OCHER YELLOW <b>E7</b> , PAPAYA ORANGE <b>EA</b> , PASTEL YELLOW <b>E4</b> , PINE GREEN <b>EJ</b> , RED <b>ER</b> , SAGE GREEN <b>E9</b> |



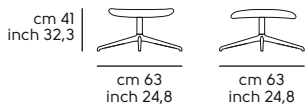

**P47 B2**



# Pippi design Roberto Paoli

**Pippi S, P, AP, H65-75 - Completely upholstered in fabric**

Frame in: metal upholstered - Metal feet

| Model   | Code    | Mod. | feet | Upholstery |       | Optional               | G.ty   | boxes  | Kg        | M <sup>3</sup> |
|---|---------|------|------|------------|-------|------------------------|--------|--------|-----------|----------------|
|   |         |      |      | TB         | TE    |                        |        |        |           |                |
| <b>Chair PIPPI S R_TS</b><br>           | S1950ST | S    | M1   | 435 €      | 579 € | FM-M2<br>FM-M4<br>ES-1 | 1<br>2 | 1<br>1 | 8<br>16.0 | 0.26<br>0.37   |
| <b>Armchair PIPPI P R_TS</b><br>        | S1950PT | P    | M1   | 474 €      | 618 € | FM-M2<br>FM-M4<br>ES-1 | 1      | 1      | 8.5       | 0.30           |
| <b>Waiting Chair PIPPI AP R_TS</b><br> | S1950AT | AP   | M1   | 568 €      | 740 € | FM-M2<br>FM-M4<br>ES-1 | 1      | 1      | 10        | 0.42           |
| <b>Stool PIPPI H65 R_TS</b><br>       | S1950HT | H65  | M1   | 515 €      | 665 € | FM-M2<br>FM-M4<br>ES-1 | 1      | 1      | 8.5       | 0.20           |
| <b>Stool PIPPI H75 R_TS</b><br>       | S1950JT | H75  | M1   | 526 €      | 679 € | FM-M2<br>FM-M4<br>ES-1 | 1      | 1      | 9         | 0.25           |

**Feet finishes**

**Metal**

|           |   |
|-----------|---|
| <b>MI</b> | WHITE <b>BB</b> , BROWN <b>E6</b> , SAND <b>EC</b> , WHITE PEARL <b>EF</b> , GRAPHITE <b>EG</b> , BLACK <b>EN</b> |
|-----------|---|

**Shell finishes**

**Upholstery**

|           |   |
|-----------|---|
| <b>TB</b> | FABRIC <b>Fenix Wool</b> , FABRIC <b>Visual</b> , FABRIC <b>Network</b> |
|-----------|---|

**Shell finishes**

**Upholstery**

|           |                               |
|-----------|-------------------------------|
| <b>TE</b> | FABRIC <b>Uniform Melange</b> |
|-----------|-------------------------------|

**Optionals:**

|              |                        | Value  | Options/notes  |
|--------------|------------------------|--------|--|
| <b>FM-M2</b> | Indoor matt metal M2   | + 23 € | ASH GREY <b>ES</b> , BLUE SAPPHIRE <b>EE</b> , BLUE TURQUOISE <b>EH</b> , BRONZE <b>E2</b> , BULGARO RED <b>FP</b> , CHERRY RED <b>EQ</b> , DARK GREEN <b>EL</b> , FACEPOWDER PINK <b>E8</b> , FANGO <b>E3</b> , GOLDEN YELLOW <b>EO</b> , LIGHT BLUE <b>EO</b> , LIGHT GREY <b>ET</b> , OCEAN BLUE <b>E1</b> , OCHER YELLOW <b>E7</b> , PAPAYA ORANGE <b>EA</b> , PASTEL YELLOW <b>E4</b> , PINE GREEN <b>EJ</b> , RED <b>ER</b> , SAGE GREEN <b>E9</b> |
| <b>FM-M4</b> | Indoor glossy Metal M4 | + 52 € | BLACK NICKEL <b>DZ</b> , CHAMPAGNE GOLD <b>DG</b> , GOLDEN BRONZE <b>DB</b> , MATT BLACK NICKEL <b>DY</b> , MATT GOLDEN BRONZE <b>DC</b> , PINK GOLD <b>DR</b>   |
| <b>ES-1</b>  | Fireproof foam         | + 7 €  | ES-1   |

**Pippi S**

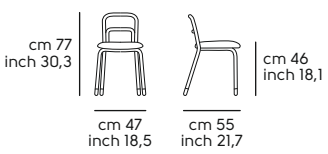

**Pippi P**

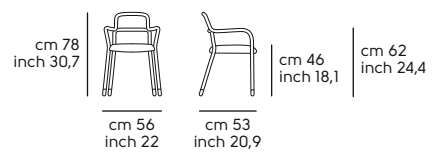

**Pippi AP**

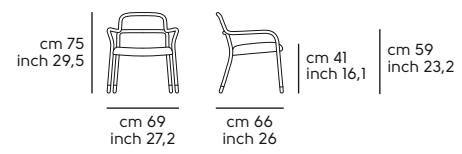

**Pippi H65**

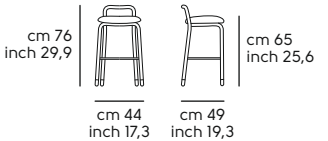

**Pippi H75**

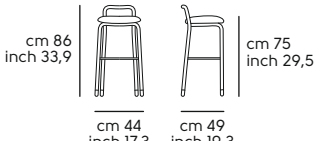

# Piuma design Paolo Vernier

**Piuma S, P, H65-75 - Seat and back in hide, fabric or leather, wood**

Frame in: metal

| Model   | Code    | Mod. | Frame and Insert | Seat and Backrest |  |  |  |       |  |  |  | Optional                        | Q.ty | boxes | Kg  | M <sup>3</sup> |
|---|---------|------|------------------|-------------------|--|--|--|-------|--|--|--|---------------------------------|------|-------|-----|----------------|
|   |         |      |                  | CU                |  |  |  | CT    |  |  |  |                                 |      |       |     |                |
| <b>Chair PIUMA S M CU</b><br> | S2210SC | S    | MI               | 461 €             |  |  |  | 553 € |  |  |  | FM-M2<br>FM-M4<br>ES-1<br>PD-FO | 2    | 1     | 8.4 | 0.29           |







| Model   | Code    | Mod. | Frame and Insert | TA    | TB    | TC    | TD    | TE    | SF    | SV    | COM   | COL   | Optional                        | Q.ty | boxes | Kg  | M <sup>3</sup> |
|---|---------|------|------------------|-------|-------|-------|-------|-------|-------|-------|-------|-------|---------------------------------|------|-------|-----|----------------|
|   |         |      |                  |       |       |       |       |       |       |       |       |       |                                 |      |       |     |                |
| <b>Chair PIUMA S M TS</b><br> | S2210ST | S    | MI               | 375 € | 397 € | 421 € | 439 € | 499 € | 488 € | 566 € | 375 € | 421 € | FM-M2<br>FM-M4<br>ES-1<br>PD-FO | 2    | 1     | 8.4 | 0.29           |

| Model   | Code    | Mod. | Frame and Insert | LI1   |  |  |  | LI2   |  |  |  | Optional                | Q.ty | boxes | Kg  | M <sup>3</sup> |
|---|---------|------|------------------|-------|--|--|--|-------|--|--|--|-------------------------|------|-------|-----|----------------|
|   |         |      |                  |       |  |  |  |       |  |  |  |                         |      |       |     |                |
| <b>Chair PIUMA S M LG</b><br> | S2210SW | S    | MI               | 415 € |  |  |  | 428 € |  |  |  | FM-M2<br>FM-M4<br>PD-FO | 2    | 1     | 8.4 | 0.29           |

| Model  | Code    | Mod. | Frame and Insert | Seat and Backrest |  |  |  |       |  |  |  | Optional                        | Q.ty | boxes | Kg  | M <sup>3</sup> |
|--|---------|------|------------------|-------------------|--|--|--|-------|--|--|--|---------------------------------|------|-------|-----|----------------|
|  |         |      |                  | CU                |  |  |  | CT    |  |  |  |                                 |      |       |     |                |
| <b>Armchair PIUMA P M CU</b><br> | S2210PC | P    | MI               | 480 €             |  |  |  | 573 € |  |  |  | FM-M2<br>FM-M4<br>ES-1<br>PD-FO | 1    | 1     | 5.7 | 0.21           |

| Model  | Code    | Mod. | Frame and Insert | TA    | TB    | TC    | TD    | TE    | SF    | SV    | COM   | COL   | Optional                        | Q.ty | boxes | Kg  | M <sup>3</sup> |
|--|---------|------|------------------|-------|-------|-------|-------|-------|-------|-------|-------|-------|---------------------------------|------|-------|-----|----------------|
|  |         |      |                  |       |       |       |       |       |       |       |       |       |                                 |      |       |     |                |
| <b>Armchair PIUMA P M TS</b><br> | S2210PT | P    | MI               | 458 € | 478 € | 502 € | 519 € | 580 € | 569 € | 647 € | 458 € | 502 € | FM-M2<br>FM-M4<br>ES-1<br>PD-FO | 1    | 1     | 5.7 | 0.21           |

| Model  | Code    | Mod. | Frame and Insert | LI1   |  |  |  | LI2   |  |  |  | Optional                | Q.ty | boxes | Kg  | M <sup>3</sup> |
|--|---------|------|------------------|-------|--|--|--|-------|--|--|--|-------------------------|------|-------|-----|----------------|
|  |         |      |                  |       |  |  |  |       |  |  |  |                         |      |       |     |                |
| <b>Armchair PIUMA P M LG</b><br> | S2210PW | P    | MI               | 435 € |  |  |  | 447 € |  |  |  | FM-M2<br>FM-M4<br>PD-FO | 1    | 1     | 5.7 | 0.21           |

| Model  | Code    | Mod. | Frame and Insert | Seat and Backrest |       |       |       |       |       |       |       |       |                                 | Optional                        | Q.ty | boxes | Kg   | M <sup>3</sup> |
|--|---------|------|------------------|-------------------|-------|-------|-------|-------|-------|-------|-------|-------|---------------------------------|---------------------------------|------|-------|------|----------------|
|  |         |      |                  | CU                |       |       |       |       | CT    |       |       |       |                                 |                                 |      |       |      |                |
| <b>Stool PIUMA H65 M CU</b><br>   | S2210HC | H65  | M1               | 530 €             |       |       |       |       | 623 € |       |       |       |                                 | FM-M2<br>FM-M4<br>ES-1<br>PD-F0 | 1    | 1     | 5.9  | 0.21           |
| <b>Stool PIUMA H75 M CU</b><br>   | S2210JC | H75  | M1               | 545 €             |       |       |       |       | 638 € |       |       |       |                                 | FM-M2<br>FM-M4<br>ES-1<br>PD-F0 | 1    | 1     | 6.2  | 0.23           |
|  |         |      |                  | TA                | TB    | TC    | TD    | TE    | SF    | SV    | COM   | COL   |                                 |                                 |      |       |      |                |
| <b>Stool PIUMA H65 M TS</b><br>   | S2210HT | H65  | M1               | 445 €             | 466 € | 491 € | 509 € | 569 € | 556 € | 635 € | 445 € | 491 € | FM-M2<br>FM-M4<br>ES-1<br>PD-F0 | 1                               | 1    | 5.9   | 0.21 |                |
| <b>Stool PIUMA H75 M TS</b><br>   | S2210JT | H75  | M1               | 460 €             | 480 € | 504 € | 522 € | 582 € | 571 € | 649 € | 460 € | 504 € | FM-M2<br>FM-M4<br>ES-1<br>PD-F0 | 1                               | 1    | 6.2   | 0.23 |                |
|  |         |      |                  | L11               |       |       |       |       | L12   |       |       |       |                                 |                                 |      |       |      |                |
| <b>Stool PIUMA H65 M LG</b><br> | S2210HW | H65  | M1               | 484 €             |       |       |       |       | 498 € |       |       |       |                                 | FM-M2<br>FM-M4<br>PD-F0         | 1    | 1     | 5.9  | 0.21           |
| <b>Stool PIUMA H75 M LG</b><br> | S2210JW | H75  | M1               | 498 €             |       |       |       |       | 512 € |       |       |       |                                 | FM-M2<br>FM-M4<br>PD-F0         | 1    | 1     | 6.2  | 0.23           |

**Finishes Frame and inserts**

|              |   |
|--------------|---|
| <b>Metal</b> |   |
| <b>MI</b>    | WHITE <b>BB</b> , BROWN <b>E6</b> , SAND <b>EC</b> , WHITE PEARL <b>EF</b> , GRAPHITE <b>EG</b> , BLACK <b>EN</b> |

**Finishes wing screws**

|              |                 |
|--------------|-----------------|
| <b>Metal</b> |                 |
| <b>MI</b>    | BLACK <b>EN</b> |

**Seat and Back finishes**



|             |  |
|-------------|--|
| <b>Wood</b> |  |
| <b>L11</b>  | Veneered wood painted BLACK <b>I04</b> , Veneered wood painted WHITE <b>I05</b> , Veneered wood painted CHERRY RED <b>I09</b> , Veneered wood painted DARK BROWN <b>I26</b> , Veneered wood painted NATURAL <b>I40</b> , Veneered wood painted NATURAL OAK <b>I52</b> , Veneered wood painted WHITENED <b>I60</b> , Veneered wood painted DESERT <b>I61</b> , Veneered wood painted LIGHT GREY <b>I62</b> , Veneered wood painted DARK GREY <b>I63</b> |
| <b>L12</b>  | Veneered wood NATURAL OAK <b>I22</b> , Veneered wood FLAMED WALNUT <b>I24</b>  |

**Seat and Back finishes**

|                   |   |
|-------------------|---|
| <b>Upholstery</b> |   |
| <b>TA</b>         | FAUX LEATHER <b>Secret</b> , FABRIC <b>Mirage</b> , FABRIC <b>Cotton Club</b> , FABRIC <b>Renewed Loop</b>  |
| <b>TC</b>         | VELVET SUPERB, FABRIC <b>Second</b> , FABRIC <b>Main Line Flax</b> , FABRIC <b>Oceanic</b> , FABRIC <b>Jumper</b> , FABRIC <b>Flame</b> , FABRIC <b>Ouche</b> , FABRIC <b>Plain</b> , FABRIC <b>Gemma</b> , FABRIC <b>Caltagirone 114</b> |
| <b>TE</b>         | FABRIC <b>Uniform Melange</b>   |
| <b>SV</b>         | LEATHER <b>Vintage</b>  |
| <b>CT</b>         | TUSCAN HIDE   |

|           |  |
|-----------|--|
| <b>TB</b> | FAUX LEATHER <b>Vintage</b> , FABRIC <b>Fenix Wool</b> , FABRIC <b>Visual</b> , FABRIC <b>Manhattan</b> , FABRIC <b>Novabuk</b> , FABRIC <b>Network</b> , FABRIC <b>Gyre</b> |
| <b>TD</b> | FABRIC <b>Yoredale</b> , FABRIC <b>Remix 3</b>   |
| <b>SF</b> | LEATHER <b>Fiore</b>   |
| <b>CU</b> | HIDE   |

**COM/COL - Minimum Q.ty 6 pc. for each material. For weft or patterned fabrics see specific pages**

|   |                        |  |               |
|---|------------------------|--|---------------|
|  <b>COM</b> | Mtl. 0.65 h. 1.40 Each |  <b>COL</b> | Mq. 0.80 Each |
|---|------------------------|--|---------------|

**Optionals:**

|              |                        | Value   | Options/notes  |
|--------------|------------------------|---------|--|
| <b>FM-M2</b> | Indoor matt metal M2   | + 52 €  | ASH GREY <b>ES</b> , BLUE SAPPHIRE <b>EE</b> , BLUE TURQUOISE <b>EH</b> , BRONZE <b>E2</b> , BULGARO RED <b>FP</b> , CHERRY RED <b>EQ</b> , DARK GREEN <b>EL</b> , FACEPOWDER PINK <b>E8</b> , FANGO <b>E3</b> , GOLDEN YELLOW <b>EO</b> , LIGHT BLUE <b>EO</b> , LIGHT GREY <b>ET</b> , OCEAN BLUE <b>E1</b> , OCHER YELLOW <b>E7</b> , PAPAYA ORANGE <b>EA</b> , PASTEL YELLOW <b>E4</b> , PINE GREEN <b>EJ</b> , RED <b>ER</b> , SAGE GREEN <b>E9</b> |
| <b>FM-M4</b> | Indoor glossy Metal M4 | + 139 € | BLACK NICKEL <b>DZ</b> , CHAMPAGNE GOLD <b>DG</b> , GOLDEN BRONZE <b>DB</b> , MATT BLACK NICKEL <b>DY</b> , MATT GOLDEN BRONZE <b>DC</b> , PINK GOLD <b>DR</b>   |
| <b>ES-1</b>  | Fireproof foam         | + 6 €   | ES-1   |
| <b>PD-F0</b> | Felt pad feet          | + 6 €   | PD-F0  |

**Piuma S**

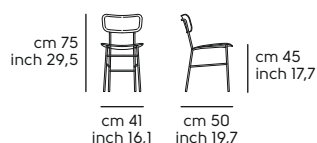

**Piuma H65**

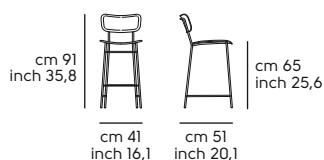

**Piuma H75**

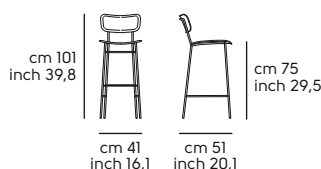

**Piuma P**

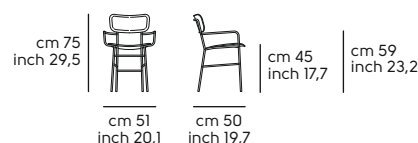

# Qua-ndo design Michi Jung & Paolo Vernier

**Qua-ndo S, P, AP, DV, H65, H75 - Seat and back in fabric or leather**

Frame in: metal

| Model   | Code    | Mod. | Frame | Seat and Backrest |       |       |       |       |       |       |       | Optional | Q.ty           | boxes | Kg | M <sup>3</sup> |      |
|---|---------|------|-------|-------------------|-------|-------|-------|-------|-------|-------|-------|----------|----------------|-------|----|----------------|------|
|   |         |      |       | TA                | TB    | TC    | TD    | TE    | SF    | SV    | COM   |          |                |       |    |                | COL  |
|  | S2190ST | S    | MI    | 362 €             | 372 € | 393 € | 408 € | 498 € | 441 € | 488 € | 362 € | 393 €    | FM-M2<br>FM-M4 | 1     | 1  | 8              | 0.24 |
|   |         |      |       |                   |       |       |       |       |       |       |       |          |                |       |    |                |      |

**COM/COL - Minimum Q.ty 6 pc. for each material. For weft or patterned fabrics see specific pages**

|  |   |
|--|---|
|  Mtl. 1.35 h. 1.40 Each |  Mq. 1.10 Each |
|--|---|

| Model  | Code    | Mod. | Frame | Seat and Backrest |       |       |       |       |    |    |       | Optional | Q.ty           | boxes | Kg | M <sup>3</sup> |      |
|--|---------|------|-------|-------------------|-------|-------|-------|-------|----|----|-------|----------|----------------|-------|----|----------------|------|
|  |         |      |       | TA                | TB    | TC    | TD    | TE    | SF | SV | COM   |          |                |       |    |                | COL  |
|  | S2190PT | P    | MI    | 683 €             | 721 € | 784 € | 826 € | 940 € | -- | -- | 683 € | --       | FM-M2<br>FM-M4 | 1     | 1  | 10             | 0.31 |
|  |         |      |       |                   |       |       |       |       |    |    |       |          |                |       |    |                |      |

**COM/COL - Minimum Q.ty 6 pc. for each material. For weft or patterned fabrics see specific pages**

|  |  |
|--|--|
|  Mtl. 2.30 h. 1.40 Each |  |
|--|--|

| Model   | Code    | Mod. | Frame | Seat and Backrest |       |         |         |         |    |    |       | Optional | Q.ty           | boxes | Kg | M <sup>3</sup> |      |
|---|---------|------|-------|-------------------|-------|---------|---------|---------|----|----|-------|----------|----------------|-------|----|----------------|------|
|   |         |      |       | TA                | TB    | TC      | TD      | TE      | SF | SV | COM   |          |                |       |    |                | COL  |
|  | S2190AT | AP   | MI    | 903 €             | 967 € | 1.070 € | 1.140 € | 1.320 € | -- | -- | 903 € | --       | FM-M2<br>FM-M4 | 1     | 1  | 13.65          | 0.48 |
|   |         |      |       |                   |       |         |         |         |    |    |       |          |                |       |    |                |      |

**COM/COL - Minimum Q.ty 6 pc. for each material. For weft or patterned fabrics see specific pages**

|  |  |
|--|--|
|  Mtl. 2.85 h. 1.40 Each |  |
|--|--|

| Model   | Code    | Mod. | Frame | Seat and Backrest |         |         |         |         |    |    |         | Optional | Q.ty           | boxes | Kg | M <sup>3</sup> |      |
|---|---------|------|-------|-------------------|---------|---------|---------|---------|----|----|---------|----------|----------------|-------|----|----------------|------|
|   |         |      |       | TA                | TB      | TC      | TD      | TE      | SF | SV | COM     |          |                |       |    |                | COL  |
|  | S2190LT | DV   | MI    | 1.408 €           | 1.505 € | 1.656 € | 1.761 € | 2.033 € | -- | -- | 1.408 € | --       | FM-M2<br>FM-M4 | 1     | 1  | 23.5           | 0.82 |
|   |         |      |       |                   |         |         |         |         |    |    |         |          |                |       |    |                |      |

**COM/COL - Minimum Q.ty 6 pc. for each material. For weft or patterned fabrics see specific pages**

|  |  |
|--|--|
|  Mtl. 4.10 h. 1.40 Each |  |
|--|--|

| Model  | Code    | Mod. | Frame | Seat and Backrest |       |       |       |       |       |       |       |       | Optional       | Q.ty | boxes | Kg | M <sup>3</sup> |
|--|---------|------|-------|-------------------|-------|-------|-------|-------|-------|-------|-------|-------|----------------|------|-------|----|----------------|
|  |         |      |       | TA                | TB    | TC    | TD    | TE    | SF    | SV    | COM   | COL   |                |      |       |    |                |
|  <b>Stool QUA-NDO H65 M TS</b> | S2190HT | H65  | M1    | 424 €             | 436 € | 457 € | 471 € | 562 € | 503 € | 550 € | 424 € | 457 € | FM-M2<br>FM-M4 | 1    | 1     | 9  | 0.29           |

**COM/COL - Minimum Q.ty 6 pc. for each material. For weft or patterned fabrics see specific pages**

|   |   |
|---|---|
|  Mtl. 1.35 h. 1.40 Each |  Mq. 1.10 Each |
|---|---|

| Model  | Code    | Mod. | Frame | Seat and Backrest |       |       |       |       |       |       |       |       | Optional       | Q.ty | boxes | Kg | M <sup>3</sup> |
|--|---------|------|-------|-------------------|-------|-------|-------|-------|-------|-------|-------|-------|----------------|------|-------|----|----------------|
|  |         |      |       | TA                | TB    | TC    | TD    | TE    | SF    | SV    | COM   | COL   |                |      |       |    |                |
|  <b>Stool QUA-NDO H75 M TS</b> | S2190JT | H75  | M1    | 436 €             | 446 € | 467 € | 482 € | 572 € | 515 € | 562 € | 436 € | 467 € | FM-M2<br>FM-M4 | 1    | 1     | 10 | 0.32           |

**COM/COL - Minimum Q.ty 6 pc. for each material. For weft or patterned fabrics see specific pages**

|   |   |
|---|---|
|  Mtl. 1.35 h. 1.40 Each |  Mq. 1.10 Each |
|---|---|

**Frame finishes**

**Metal**

**MI** WHITE **BB**, BROWN **E6**, SAND **EC**, WHITE PEARL **EF**, GRAPHITE **EG**, BLACK **EN**

**Seat and Back finishes**

**Upholstery**

|           |   |           |  |
|-----------|---|-----------|--|
| <b>TA</b> | FAUX LEATHER <b>Secret</b> , FABRIC <b>Mirage</b> , FABRIC <b>Cotton Club</b> , FABRIC <b>Renewed Loop</b>  | <b>TB</b> | FAUX LEATHER <b>Vintage</b> , FABRIC <b>Fenix Wool</b> , FABRIC <b>Visual</b> , FABRIC <b>Manhattan</b> , FABRIC <b>Novabuk</b> , FABRIC <b>Network</b> , FABRIC <b>Gyre</b> |
| <b>TC</b> | VELVET SUPERB, FABRIC <b>Second</b> , FABRIC <b>Main Line Flax</b> , FABRIC <b>Oceanic</b> , FABRIC <b>Jumper</b> , FABRIC <b>Flame</b> , FABRIC <b>Ouche</b> , FABRIC <b>Plain</b> , FABRIC <b>Gemma</b> , FABRIC <b>Caltagirone 114</b> | <b>TD</b> | FABRIC <b>Yoredale</b> , FABRIC <b>Remix 3</b>   |
| <b>TE</b> | FABRIC <b>Uniform Melange</b>   | <b>SF</b> | LEATHER <b>Fiore</b>   |
| <b>SV</b> | LEATHER <b>Vintage</b>  |           |  |

**Options:**

|              | Value   | Options/notes  |
|--------------|---------|--|
| <b>FM-M2</b> | + 63 €  | Indoor matt metal M2<br>ASH GREY <b>ES</b> , BLUE SAPPHIRE <b>EE</b> , BLUE TURQUOISE <b>EH</b> , BRONZE <b>E2</b> , BULGARO RED <b>FP</b> , CHERRY RED <b>EQ</b> , DARK GREEN <b>EL</b> , FACEPOWDER PINK <b>E8</b> , FANGO <b>E3</b> , GOLDEN YELLOW <b>EO</b> , LIGHT BLUE <b>EO</b> , LIGHT GREY <b>ET</b> , OCEAN BLUE <b>EI</b> , OCHER YELLOW <b>E7</b> , PAPAYA ORANGE <b>EA</b> , PASTEL YELLOW <b>E4</b> , PINE GREEN <b>EJ</b> , RED <b>ER</b> , SAGE GREEN <b>E9</b> |
| <b>FM-M4</b> | + 198 € | Indoor glossy Metal M4<br>BLACK NICKEL <b>DZ</b> , CHAMPAGNE GOLD <b>DG</b> , GOLDEN BRONZE <b>DB</b> , MATT BLACK NICKEL <b>DY</b> , MATT GOLDEN BRONZE <b>DC</b> , PINK GOLD <b>DR</b>   |

**Qua-ndo S**

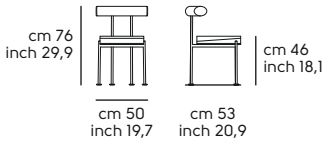

**Qua-ndo P**

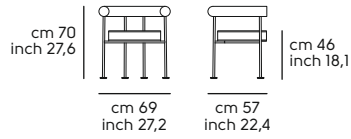

**Qua-ndo AP**

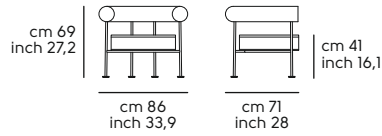

**Qua-ndo DV**

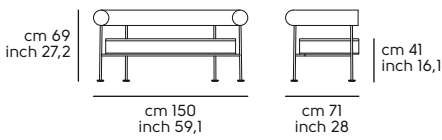

**Qua-ndo H65**

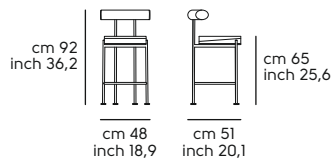

**Qua-ndo H75**

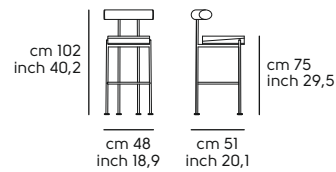

# S1 design Paola Navone

## S1 - Chair in fabric or leather upholstered

Frame with bases in: upholstered metal , Feet available in two heights H.35 - H.100

| Model  | Code    | Mod. | feet | Upholstery |       |       |       |       |       |       |       |       | Optional                | G.ty | boxes | Kg | M <sup>3</sup> |
|--|---------|------|------|------------|-------|-------|-------|-------|-------|-------|-------|-------|-------------------------|------|-------|----|----------------|
|  |         |      |      | TA         | TB    | TC    | TD    | TE    | SF    | SV    | COM   | COL   |                         |      |       |    |                |
|  | S2180SB | S    | MI   | 477 €      | 520 € | 591 € | 634 € | 786 € | 684 € | 809 € | 477 € | 591 € | ZP-A0<br>FM-M2<br>FM-M4 | 2    | 1     | 16 | 0.41           |

COM/COL - Minimum Q.ty 6 pc. for each material. For weft or patterned fabrics see specific pages

| COM   | Mtl. 1.45 h. 1.40 Each | COL | Mq. 2.60 Each |       |       |       |       |       |       |       |       |       |                         |   |   |      |      |
|---|------------------------|-----|---------------|-------|-------|-------|-------|-------|-------|-------|-------|-------|-------------------------|---|---|------|------|
|  | S2180SO                | M   | MI            | 499 € | 549 € | 622 € | 667 € | 818 € | 714 € | 848 € | 504 € | 622 € | ZP-A0<br>FM-M2<br>FM-M4 | 2 | 1 | 16.5 | 0.43 |

COM/COL - Minimum Q.ty 6 pc. for each material. For weft or patterned fabrics see specific pages

| COM  | Mtl. 1.65 h. 1.40 Each | COL | Mq. 2.60 Each |       |       |       |       |       |       |       |       |       |                         |   |   |      |      |
|--|------------------------|-----|---------------|-------|-------|-------|-------|-------|-------|-------|-------|-------|-------------------------|---|---|------|------|
|  | S2180SA                | T   | MI            | 508 € | 560 € | 634 € | 679 € | 833 € | 728 € | 861 € | 513 € | 634 € | ZP-A0<br>FM-M2<br>FM-M4 | 2 | 1 | 16.7 | 0.49 |

COM/COL - Minimum Q.ty 6 pc. for each material. For weft or patterned fabrics see specific pages

| COM | Mtl. 1.55 h. 1.40 Each | COL | Mq. 2.95 Each |
|-----|------------------------|-----|---------------|
|-----|------------------------|-----|---------------|

**Finishes Metal Feet**

| Metal     |   |
|-----------|---|
| <b>MI</b> | WHITE <b>BB</b> , BROWN <b>E6</b> , SAND <b>EC</b> , WHITE PEARL <b>EF</b> , GRAPHITE <b>EG</b> , BLACK <b>EN</b> |

**Finishes Shell / Pipe**

| Upholstery |   |           |  |
|------------|---|-----------|--|
| <b>TA</b>  | FAUX LEATHER <b>Secret</b> , FABRIC <b>Mirage</b> , FABRIC <b>Cotton Club</b> , FABRIC <b>Renewed Loop</b>  | <b>TB</b> | FAUX LEATHER <b>Vintage</b> , FABRIC <b>Fenix Wool</b> , FABRIC <b>Visual</b> , FABRIC <b>Manhattan</b> , FABRIC <b>Novabuk</b> , FABRIC <b>Network</b> , FABRIC <b>Gyre</b> |
| <b>TC</b>  | VELVET SUPERB, FABRIC <b>Second</b> , FABRIC <b>Main Line Flax</b> , FABRIC <b>Oceanic</b> , FABRIC <b>Jumper</b> , FABRIC <b>Flame</b> , FABRIC <b>Ouche</b> , FABRIC <b>Plain</b> , FABRIC <b>Gemma</b> , FABRIC <b>Caltagirone 114</b> | <b>TD</b> | FABRIC <b>Yoredale</b> , FABRIC <b>Remix 3</b>   |
| <b>TE</b>  | FABRIC <b>Uniform Melange</b>   | <b>SF</b> | LEATHER <b>Fiore</b>   |
| <b>SV</b>  | LEATHER <b>Vintage</b>  |           |  |

**Optionals:**

|              |                        | Value  | Options/notes  |
|--------------|------------------------|--------|--|
| <b>ZP-A0</b> | Metal Feet             | + 22 € | ZP-A0  |
| <b>FM-M2</b> | Indoor matt metal M2   | + 35 € | ASH GREY <b>ES</b> , BLUE SAPPHIRE <b>EE</b> , BLUE TURQUOISE <b>EH</b> , BRONZE <b>E2</b> , BULGARO RED <b>FP</b> , CHERRY RED <b>EQ</b> , DARK GREEN <b>EL</b> , FACEPOWDER PINK <b>E8</b> , FANGO <b>E3</b> , GOLDEN YELLOW <b>EO</b> , LIGHT BLUE <b>EO</b> , LIGHT GREY <b>ET</b> , OCEAN BLUE <b>EI</b> , OCHER YELLOW <b>E7</b> , PAPAYA ORANGE <b>EA</b> , PASTEL YELLOW <b>E4</b> , PINE GREEN <b>EJ</b> , RED <b>ER</b> , SAGE GREEN <b>E9</b> |
| <b>FM-M4</b> | Indoor glossy Metal M4 | + 51 € | BLACK NICKEL <b>DZ</b> , CHAMPAGNE GOLD <b>DG</b> , GOLDEN BRONZE <b>DB</b> , MATT BLACK NICKEL <b>DY</b> , MATT GOLDEN BRONZE <b>DC</b> , PINK GOLD <b>DR</b>   |

**SIS**

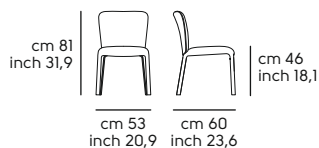

**SIM**

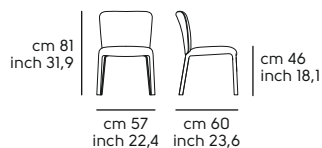

**SIT**

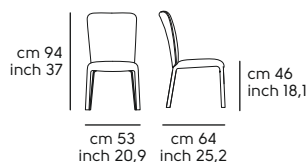

# Silvy design Officina delle Idee

## Silvy SB, SBR; SA, SAR - Shell in hide, fabric or leather

Frame in: metal or upholstered

| Model  | Code    | Mod. | Frame | Shell | Optional   | Q.ty | boxes | Kg | M <sup>3</sup> |
|--|---------|------|-------|-------|------------|------|-------|----|----------------|
|  |         |      |       |       | CU         |      |       |    |                |
| <b>Chair SILVY SB M CU</b><br> | S1490MC | SB   | M1    | 292 € | FM-M3 ES-1 | 2    | 1     | 9  | 0.31           |

| Model  | Code    | Mod. | Frame | TA    | TB    | TC    | TD    | TE    | SF    | SV    | COM   | COL   | Optional   | Q.ty | boxes | Kg | M <sup>3</sup> |
|--|---------|------|-------|-------|-------|-------|-------|-------|-------|-------|-------|-------|------------|------|-------|----|----------------|
| <b>Chair SILVY SB M TS</b><br> | S1490MT | SB   | M1    | 209 € | 228 € | 274 € | 302 € | 402 € | 308 € | 364 € | 209 € | 274 € | FM-M3 ES-1 | 2    | 1     | 9  | 0.33           |



**COM/COL - Minimum Q.ty 6 pc. for each material. For weft or patterned fabrics see specific pages**

|  |                        |   |               |
|--|------------------------|---|---------------|
| <b>COM</b><br> | Mtl. 1.00 h. 1.40 Each | <b>COL</b><br> | Mq. 1.65 Each |
|--|------------------------|---|---------------|

| Model  | Code    | Mod. | -- | Upholstery | Optional | Q.ty | boxes | Kg | M <sup>3</sup> |
|--|---------|------|----|------------|----------|------|-------|----|----------------|
|  |         |      |    |            | CU       |      |       |    |                |
| <b>Chair SILVY SB R CU</b><br> | S1490SC | SB   |    | 309 €      | ES-1     | 2    | 1     | 9  | 0.31           |

| Model  | Code    | Mod. | Frame | TA    | TB    | TC    | TD    | TE    | SF    | SV    | COM   | COL   | Optional | Q.ty | boxes | Kg | M <sup>3</sup> |
|--|---------|------|-------|-------|-------|-------|-------|-------|-------|-------|-------|-------|----------|------|-------|----|----------------|
| <b>Chair SILVY SB R TS</b><br> | S1490ST | SB   |       | 229 € | 261 € | 330 € | 335 € | 445 € | 370 € | 418 € | 232 € | 330 € | ES-1     | 2    | 1     | 9  | 0.33           |



**COM/COL - Minimum Q.ty 6 pc. for each material. For weft or patterned fabrics see specific pages**

|  |                        |   |               |
|--|------------------------|---|---------------|
| <b>COM</b><br> | Mtl. 1.00 h. 1.40 Each | <b>COL</b><br> | Mq. 1.70 Each |
|--|------------------------|---|---------------|

| Model   | Code    | Mod. | Frame | Shell |  |  |  |  |  |  |  | Optional      | Q.ty | boxes | Kg | M <sup>3</sup> |
|---|---------|------|-------|-------|--|--|--|--|--|--|--|---------------|------|-------|----|----------------|
| CU  |         |      |       |       |  |  |  |  |  |  |  |               |      |       |    |                |
|  | S1490RC | SA   | M1    | 310 € |  |  |  |  |  |  |  | FM-M3<br>ES-1 | 2    | 1     | 9  | 0.35           |

| Model   | Code    | Mod. | Frame | TA    | TB    | TC    | TD    | TE    | SF    | SV    | COM   | COL   | Optional      | Q.ty | boxes | Kg | M <sup>3</sup> |
|---|---------|------|-------|-------|-------|-------|-------|-------|-------|-------|-------|-------|---------------|------|-------|----|----------------|
|  | S1490RT | SA   | M1    | 228 € | 250 € | 304 € | 334 € | 444 € | 330 € | 397 € | 231 € | 304 € | FM-M3<br>ES-1 | 2    | 1     | 9  | 0.35           |



**COM/COL - Minimum Q.ty 6 pc. for each material. For weft or patterned fabrics see specific pages**

|   |                        |   |               |
|---|------------------------|---|---------------|
|  | Mtl. 1.10 h. 1.40 Each |  | Mq. 1.39 Each |
|---|------------------------|---|---------------|

| Model  | Code    | Mod. | -- | Upholstery |  |  |  |  |  |  |  | Optional | Q.ty | boxes | Kg | M <sup>3</sup> |
|--|---------|------|----|------------|--|--|--|--|--|--|--|----------|------|-------|----|----------------|
| CU   |         |      |    |            |  |  |  |  |  |  |  |          |      |       |    |                |
|  | S1490UC | SA   |    | 344 €      |  |  |  |  |  |  |  | ES-1     | 2    | 1     | 9  | 0.35           |

| Model   | Code    | Mod. | -- | TA    | TB    | TC    | TD    | TE    | SF    | SV    | COM   | COL   | Optional | Q.ty | boxes | Kg | M <sup>3</sup> |
|---|---------|------|----|-------|-------|-------|-------|-------|-------|-------|-------|-------|----------|------|-------|----|----------------|
|  | S1490UT | SA   |    | 256 € | 280 € | 333 € | 359 € | 469 € | 379 € | 430 € | 256 € | 333 € | ES-1     | 2    | 1     | 9  | 0.35           |

**COM/COL - Minimum Q.ty 6 pc. for each material. For weft or patterned fabrics see specific pages**

|   |                        |   |               |
|---|------------------------|---|---------------|
|  | Mtl. 1.10 h. 1.40 Each |  | Mq. 1.73 Each |
|---|------------------------|---|---------------|

**Frame finishes**

|              |   |
|--------------|---|
| <b>Metal</b> |   |
| <b>MI</b>    | WHITE <b>BB</b> , BROWN <b>E6</b> , SAND <b>EC</b> , WHITE PEARL <b>EF</b> , GRAPHITE <b>EG</b> , BLACK <b>EN</b> |

**Shell finishes**

|                   |   |           |  |
|-------------------|---|-----------|--|
| <b>Upholstery</b> |   |           |  |
| <b>TA</b>         | FAUX LEATHER <b>Secret</b> , FABRIC <b>Mirage</b> , FABRIC <b>Cotton Club</b> , FABRIC <b>Renewed Loop</b>  | <b>TB</b> | FAUX LEATHER <b>Vintage</b> , FABRIC <b>Fenix Wool</b> , FABRIC <b>Visual</b> , FABRIC <b>Manhattan</b> , FABRIC <b>Novabuk</b> , FABRIC <b>Network</b> , FABRIC <b>Gyre</b> |
| <b>TC</b>         | VELVET SUPERB, FABRIC <b>Second</b> , FABRIC <b>Main Line Flax</b> , FABRIC <b>Oceanic</b> , FABRIC <b>Jumper</b> , FABRIC <b>Flame</b> , FABRIC <b>Ouche</b> , FABRIC <b>Plain</b> , FABRIC <b>Gemma</b> , FABRIC <b>Caltagirone 114</b> | <b>TD</b> | FABRIC <b>Yoredale</b> , FABRIC <b>Remix 3</b>   |
| <b>TE</b>         | FABRIC <b>Uniform Melange</b>   | <b>SF</b> | LEATHER <b>Fiore</b>   |
| <b>SV</b>         | LEATHER <b>Vintage</b>  | <b>CU</b> | HIDE   |

**Optionals:**

|              |                        | Value  | Options/notes    |
|--------------|------------------------|--------|------------------|
| <b>FM-M3</b> | Indoor glossy metal M3 | + 21 € | CHROME <b>CC</b> |
| <b>ES-1</b>  | Fireproof foam         | + 7 €  | ES-1             |

**Silvy SB**

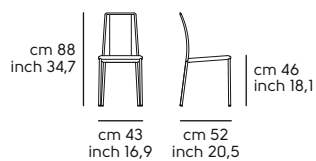



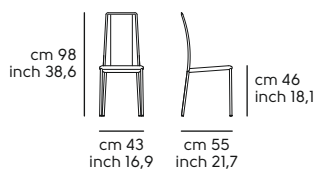





**Silvy SA**



**Silvy H65-H75 - Shell in hide, fabric or leather**

Frame in: metal

| Model   | Code    | Mod. | Frame | Shell |       |       |       |       |       |       |       |       | Optional   | Q.ty       | boxes | Kg | M <sup>2</sup> |      |
|---|---------|------|-------|-------|-------|-------|-------|-------|-------|-------|-------|-------|------------|------------|-------|----|----------------|------|
| CU  |         |      |       |       |       |       |       |       |       |       |       |       |            |            |       |    |                |      |
| <b>Stool SILVY H65 M CU</b><br>     | S1490IC | H65  | M1    |       |       |       |       |       |       |       |       |       | 318 €      | FM-M3 ES-1 | 2     | 1  | 9              | 0.27 |
| <b>Stool SILVY H75 M CU</b><br>     | S1490KC | H75  | M1    |       |       |       |       |       |       |       |       |       | 330 €      | FM-M3 ES-1 | 2     | 1  | 10             | 0.29 |
|   |         |      |       | TA    | TB    | TC    | TD    | TE    | SF    | SV    | COM   | COL   |            |            |       |    |                |      |
| <b>Stool SILVY H65 M TS</b><br>     | S1490IT | H65  | M1    | 255 € | 280 € | 301 € | 312 € | 371 € | 315 € | 369 € | 255 € | 301 € | FM-M3 ES-1 | 2          | 1     | 9  | 0.28           |      |
| <b>Stool SILVY H75 M TS</b><br>  | S1490KT | H75  | M1    | 268 € | 294 € | 315 € | 323 € | 384 € | 327 € | 382 € | 268 € | 315 € | FM-M3 ES-1 | 2          | 1     | 10 | 0.29           |      |



**Frame finishes**

|              |   |
|--------------|---|
| <b>Metal</b> |   |
| <b>MI</b>    | WHITE <b>BB</b> , BROWN <b>E6</b> , SAND <b>EC</b> , WHITE PEARL <b>EF</b> , GRAPHITE <b>EG</b> , BLACK <b>EN</b> |

**Shell finishes**

|                   |   |           |  |
|-------------------|---|-----------|--|
| <b>Upholstery</b> |   |           |  |
| <b>TA</b>         | FAUX LEATHER <b>Secret</b> , FABRIC <b>Mirage</b> , FABRIC <b>Cotton Club</b> , FABRIC <b>Renewed Loop</b>  | <b>TB</b> | FAUX LEATHER <b>Vintage</b> , FABRIC <b>Fenix Wool</b> , FABRIC <b>Visual</b> , FABRIC <b>Manhattan</b> , FABRIC <b>Novabuk</b> , FABRIC <b>Network</b> , FABRIC <b>Gyre</b> |
| <b>TC</b>         | VELVET SUPERB, FABRIC <b>Second</b> , FABRIC <b>Main Line Flax</b> , FABRIC <b>Oceanic</b> , FABRIC <b>Jumper</b> , FABRIC <b>Flame</b> , FABRIC <b>Ouche</b> , FABRIC <b>Plain</b> , FABRIC <b>Gemma</b> , FABRIC <b>Caltagirone 114</b> | <b>TD</b> | FABRIC <b>Yoredale</b> , FABRIC <b>Remix 3</b>   |
| <b>TE</b>         | FABRIC <b>Uniform Melange</b>   | <b>SF</b> | LEATHER <b>Fiore</b>   |
| <b>SV</b>         | LEATHER <b>Vintage</b>  | <b>CU</b> | HIDE   |

**COM/COL - Minimum Q.ty 6 pc. for each material. For weft or patterned fabrics see specific pages**

|  |                        |   |               |
|--|------------------------|---|---------------|
| <b>COM</b><br> | Mtl. 0.60 h. 1.40 Each | <b>COL</b><br> | Mq. 1.04 Each |
|--|------------------------|---|---------------|

**Optionals:**

|              |                        | Value  | Options/notes    |
|--------------|------------------------|--------|------------------|
| <b>FM-M3</b> | Indoor glossy metal M3 | + 21 € | CHROME <b>CC</b> |
| <b>ES-1</b>  | Fireproof foam         | + 7 €  | ES-1             |

**Silvy H65**

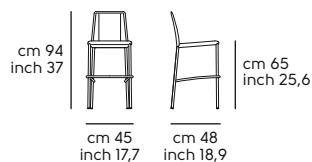



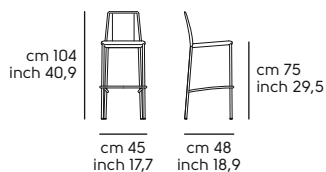





**Silvy H75**



# Slim design Paolo Vernier

## Slim S, H65-75 - Seat and back in metal

Frame in: metal

| Model  | Code    | Mod. | -- | Frame |       |       |       | Optional | G.ty   | boxes      | Kg           | M <sup>3</sup> |
|--|---------|------|----|-------|-------|-------|-------|----------|--------|------------|--------------|----------------|
|  |         |      |    | M1    | M2    | O1    | O2    |          |        |            |              |                |
| <b>Chair SLIM S M</b><br>   | S1731S0 | S    |    | 213 € | 276 € | 328 € | 390 € | 2<br>4   | 1<br>1 | 14<br>29.0 | 0.27<br>0.44 |                |
| <br>O1-O2<br>x4<br>  |         |      |    |       |       |       |       |          |        |            |              |                |
| <b>Stool SLIM H65 M</b><br>   | S1731H0 | H65  |    | 276 € | 345 € | 390 € | 460 € | 1        | 1      | 17         | 0.34         |                |
| <br>O1-O2<br>x4<br>  |         |      |    |       |       |       |       |          |        |            |              |                |
| <b>Stool SLIM H75 M</b><br>  | S1731J0 | H75  |    | 288 € | 358 € | 402 € | 473 € | 1        | 1      | 20         | 0.37         |                |
| <br>O1-O2<br>x4<br> |         |      |    |       |       |       |       |          |        |            |              |                |

### Frame finishes

#### Metal

|           |  |
|-----------|--|
| <b>M1</b> | WHITE <b>BB</b> , INDUSTRIAL <b>E5</b> , BROWN <b>E6</b> , SAND <b>EC</b> , WHITE PEARL <b>EF</b> , GRAPHITE <b>EG</b> , BLACK <b>EN</b>   |
| <b>M2</b> | LIGHT BLUE <b>E0</b> , OCEAN BLUE <b>E1</b> , BRONZE <b>E2</b> , FANGO <b>E3</b> , PASTEL YELLOW <b>E4</b> , OCHER YELLOW <b>E7</b> , FACEPOWDER PINK <b>E8</b> , SAGE GREEN <b>E9</b> , PAPAYA ORANGE <b>EA</b> , BLUE SAPPHIRE <b>EE</b> , BLUE TURQUOISE <b>EH</b> , PINE GREEN <b>EJ</b> , DARK GREEN <b>EL</b> , GOLDEN YELLOW <b>EO</b> , CHERRY RED <b>EQ</b> , RED <b>ER</b> , ASH GREY <b>ES</b> , LIGHT GREY <b>ET</b> , BULGARO RED <b>FP</b> |

#### Metal Outdoor

|           |  |
|-----------|--|
| <b>O1</b> | Outdoor BROWN <b>E6</b> , Outdoor WHITE <b>BB</b> , Outdoor SAND <b>EC</b> , Outdoor WHITE PEARL <b>EF</b> , Outdoor GRAFITE <b>EG</b> , Outdoor BLACK <b>EN</b>   |
| <b>O2</b> | Outdoor LIGHT BLUE <b>E0</b> , Outdoor OCEAN BLUE <b>E1</b> , Outdoor BRONZE <b>E2</b> , Outdoor FANGO <b>E3</b> , Outdoor PASTEL YELLOW <b>E4</b> , Outdoor OCHER YELLOW <b>E7</b> , Outdoor FACEPOWDER PINK <b>E8</b> , Outdoor SAGE GREEN <b>E9</b> , Outdoor BLUE SAPPHIRE <b>EE</b> , Outdoor BLUE TURQUOISE <b>EH</b> , Outdoor PINE GREEN <b>EJ</b> , Outdoor DARK GREEN <b>EL</b> , Outdoor GOLD YELLOW <b>EO</b> , Outdoor RED BULGARO <b>FP</b> , Outdoor CHERRY RED <b>EQ</b> , Outdoor RED <b>ER</b> , Outdoor ASH GREY <b>ES</b> , Outdoor LIGHT GREY <b>ET</b> , Outdoor PAPAYA ORANGE <b>EA</b> |

#### Slim S

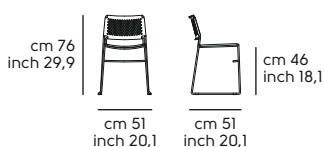

#### Slim H65

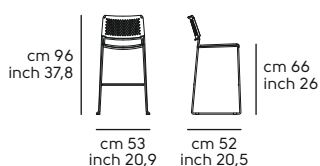

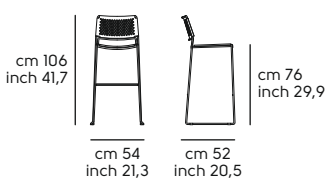

#### Slim H75







**Slim S, H65-75 - Seat and back in hide, fabric or leather**

Frame in: metal

| Model  | Code    | Mod. | Frame | Seat and Backrest |       |  |  |  |  |  |  | Optional               | Q.ty   | boxes  | Kg         | M³           |
|--|---------|------|-------|-------------------|-------|--|--|--|--|--|--|------------------------|--------|--------|------------|--------------|
|  |         |      |       | CU                | CT    |  |  |  |  |  |  |                        |        |        |            |              |
| <br><br> | S1730SC | S    | MI    |                   |       |  |  |  |  |  |  | FM-M2<br>FM-M4<br>ES-1 | 2<br>4 | 1<br>1 | 14<br>29.0 | 0.27<br>0.44 |
|  |         |      |       | 391 €             | 488 € |  |  |  |  |  |  |                        |        |        |            |              |

| Model | Code | Mod. | Frame | TA   | TB      | TC | TD | TE    | SF    | SV    | COM   | COL   | Optional | Q.ty | boxes | Kg | M³ |
|-------|------|------|-------|--|---------|----|----|-------|-------|-------|-------|-------|----------|------|-------|----|----|
|       |      |      |       | <br><br> | S1730ST | S  | MI | 295 € | 327 € | 361 € | 376 € | 432 € |          |      |       |    |    |

| Model   | Code    | Mod. | Frame | Seat and Backrest |       |  |  |  |  |  |  | Optional               | Q.ty | boxes | Kg  | M³   |
|---|---------|------|-------|-------------------|-------|--|--|--|--|--|--|------------------------|------|-------|-----|------|
|   |         |      |       | CU                | CT    |  |  |  |  |  |  |                        |      |       |     |      |
| <br>  | S1730HC | H65  | MI    |                   |       |  |  |  |  |  |  | FM-M2<br>FM-M4<br>ES-1 | 1    | 1     | 8.5 | 0.25 |
|   |         |      |       | 434 €             | 532 € |  |  |  |  |  |  |                        |      |       |     |      |
| <br> | S1730JC | H75  | MI    |                   |       |  |  |  |  |  |  | FM-M2<br>FM-M4<br>ES-1 | 1    | 1     | 10  | 0.28 |
|   |         |      |       | 448 €             | 548 € |  |  |  |  |  |  |                        |      |       |     |      |

| Model   | Code    | Mod.  | Frame | TA  | TB      | TC    | TD    | TE    | SF    | SV    | COM   | COL   | Optional               | Q.ty | boxes | Kg | M³   |
|---|---------|-------|-------|---|---------|-------|-------|-------|-------|-------|-------|-------|------------------------|------|-------|----|------|
|   |         |       |       | <br> | S1730HT | H65   | MI    | 347 € | 380 € | 417 € | 435 € | 487 € |                        |      |       |    |      |
| 361 €   | 392 €   | 432 € | 449 € |   |         |       |       | 500 € | 463 € | 505 € | 361 € | 432 € |                        |      |       |    |      |
| <br> | S1730JT | H75   | MI    | 361 €   | 392 €   | 432 € | 449 € | 500 € | 463 € | 505 € | 361 € | 432 € | FM-M2<br>FM-M4<br>ES-1 | 1    | 1     | 10 | 0.28 |
|   |         |       |       | 361 €   | 392 €   | 432 € | 449 € | 500 € | 463 € | 505 € | 361 € | 432 € |                        |      |       |    |      |

**Frame finishes**

**Metal**



|           |  |
|-----------|--|
| <b>MI</b> | WHITE <b>BB</b> , INDUSTRIAL <b>E5</b> , BROWN <b>E6</b> , SAND <b>EC</b> , WHITE PEARL <b>EF</b> , GRAPHITE <b>EG</b> , BLACK <b>EN</b> |
|-----------|--|

**Seat and Back finishes**

**Upholstery**

|           |   |           |  |
|-----------|---|-----------|--|
| <b>TA</b> | FAUX LEATHER <b>Secret</b> , FABRIC <b>Mirage</b> , FABRIC <b>Cotton Club</b> , FABRIC <b>Renewed Loop</b>  | <b>TB</b> | FAUX LEATHER <b>Vintage</b> , FABRIC <b>Fenix Wool</b> , FABRIC <b>Visual</b> , FABRIC <b>Manhattan</b> , FABRIC <b>Novabuk</b> , FABRIC <b>Network</b> , FABRIC <b>Gyre</b> |
| <b>TC</b> | VELVET SUPERB, FABRIC <b>Second</b> , FABRIC <b>Main Line Flax</b> , FABRIC <b>Oceanic</b> , FABRIC <b>Jumper</b> , FABRIC <b>Flame</b> , FABRIC <b>Ouche</b> , FABRIC <b>Plain</b> , FABRIC <b>Gemma</b> , FABRIC <b>Caltagirone 114</b> | <b>TD</b> | FABRIC <b>Yoredale</b> , FABRIC <b>Remix 3</b>   |
| <b>TE</b> | FABRIC <b>Uniform Melange</b>   | <b>SF</b> | LEATHER <b>Fiore</b>   |
| <b>SV</b> | LEATHER <b>Vintage</b>  | <b>CU</b> | HIDE   |
| <b>CT</b> | TUSCAN HIDE   |           |  |

**COM/COL - Minimum Q.ty 6 pc. for each material. For weft or patterned fabrics see specific pages**

|  |                        |  |               |
|--|------------------------|--|---------------|
|  <b>COM</b> | Mtl. 0.70 h. 1.40 Each |  <b>COL</b> | Mq. 1.11 Each |
|--|------------------------|--|---------------|

**Optionals:**

|              |                        | Value  | Options/notes  |
|--------------|------------------------|--------|--|
| <b>FM-M2</b> | Indoor matt metal M2   | + 48 € | ASH GREY <b>ES</b> , BLUE SAPPHIRE <b>EE</b> , BLUE TURQUOISE <b>EH</b> , BRONZE <b>E2</b> , BULGARO RED <b>FP</b> , CHERRY RED <b>EQ</b> , DARK GREEN <b>EL</b> , FACEPOWDER PINK <b>E8</b> , FANGO <b>E3</b> , GOLDEN YELLOW <b>EO</b> , LIGHT BLUE <b>EO</b> , LIGHT GREY <b>ET</b> , OCEAN BLUE <b>E1</b> , OCHER YELLOW <b>E7</b> , PAPAYA ORANGE <b>EA</b> , PASTEL YELLOW <b>E4</b> , PINE GREEN <b>EJ</b> , RED <b>ER</b> , SAGE GREEN <b>E9</b> |
| <b>FM-M4</b> | Indoor glossy Metal M4 | + 81 € | BLACK NICKEL <b>DZ</b> , CHAMPAGNE GOLD <b>DG</b> , GOLDEN BRONZE <b>DB</b> , MATT BLACK NICKEL <b>DY</b> , MATT GOLDEN BRONZE <b>DC</b> , PINK GOLD <b>DR</b>   |
| <b>ES-1</b>  | Fireproof foam         | + 6 €  | ES-1   |

**Slim S**

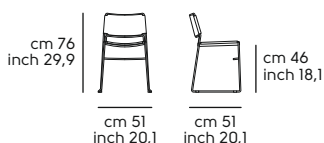

**Slim H65**

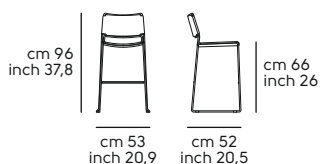



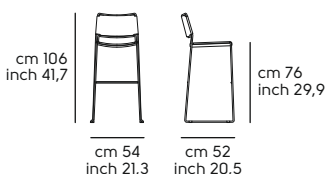



**Slim H75**



# Soffio design Carlesi e Tonelli Studio

## Soffio S - Completely upholstered in fabric or leather

Frame in: metal upholstered

| Model  | Code    | Mod. | -- | Upholstery |       |       |       |       |       |       |       |       | Optional | Q.ty<br> | boxes<br> | Kg<br> | M³<br> |
|--|---------|------|----|------------|-------|-------|-------|-------|-------|-------|-------|-------|----------|---|--|---|---|
|  |         |      |    | TA         | TB    | TC    | TD    | TE    | SF    | SV    | COM   | COL   |          |   |  |   |   |
| <br>Chair SOFFIO S_R TS<br> | SI510ST | S    |    | 320 €      | 346 € | 402 € | 427 € | 543 € | 494 € | 599 € | 320 € | 402 € | ES-1     | 2   | 1  | 18  | 0.38  |

### Finishes

### Upholstery

|           |   |           |  |
|-----------|---|-----------|--|
| <b>TA</b> | FAUX LEATHER <b>Secret</b> , FABRIC <b>Mirage</b> , FABRIC <b>Cotton Club</b> , FABRIC <b>Renewed Loop</b>  | <b>TB</b> | FAUX LEATHER <b>Vintage</b> , FABRIC <b>Fenix Wool</b> , FABRIC <b>Visual</b> , FABRIC <b>Manhattan</b> , FABRIC <b>Novabuk</b> , FABRIC <b>Network</b> , FABRIC <b>Gyre</b> |
| <b>TC</b> | VELVET SUPERB, FABRIC <b>Second</b> , FABRIC <b>Main Line Flax</b> , FABRIC <b>Oceanic</b> , FABRIC <b>Jumper</b> , FABRIC <b>Flame</b> , FABRIC <b>Ouche</b> , FABRIC <b>Plain</b> , FABRIC <b>Gemma</b> , FABRIC <b>Caltagirone 114</b> | <b>TD</b> | FABRIC <b>Yoredale</b> , FABRIC <b>Remix 3</b>   |
| <b>TE</b> | FABRIC <b>Uniform Melange</b>   | <b>SF</b> | LEATHER <b>Fiore</b>   |
| <b>SV</b> | LEATHER <b>Vintage</b>  |           |  |

COM/COL - Minimum Q.ty 6 pc. for each material. For weft or patterned fabrics see specific pages

|  |                        |   |               |
|--|------------------------|---|---------------|
|  | Mtl. 1.15 h. 1.40 Each |  | Mq. 1.89 Each |
|--|------------------------|---|---------------|

### Optionals:

|             | Value          | Options/notes |
|-------------|----------------|---------------|
| <b>ES-1</b> | Fireproof foam | + 12 € ES-1   |



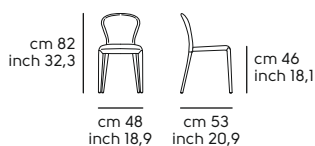







### Soffio S



# Sonny design Officina delle Idee

## Sonny S - Shell in fabric or leather

Frame in: metal or wood

| Model  | Code      | Base type | Frame | Shell |       |       |       |       |       |       |       | Optional | G.ty                             | boxes | Kg | M³   |      |
|--|-----------|-----------|-------|-------|-------|-------|-------|-------|-------|-------|-------|----------|----------------------------------|-------|----|------|------|
|  |           |           |       | TA    | TB    | TC    | TD    | TE    | SF    | SV    | COM   |          |                                  |       |    |      | COL  |
| <b>Chair SONNY S M TS_M</b><br>   | SI521MT_M | _M        | M1    | 320 € | 375 € | 457 € | 486 € | 544 € | 525 € | 624 € | 320 € | 457 €    | FM-M2<br>FM-M3<br>FM-M4<br>PD-F0 | 1     | 1  | 7    | 0.29 |
| <b>Chair SONNY S M TS_Q</b><br>   | SI521MT_Q | _Q        | M1    | 372 € | 427 € | 509 € | 538 € | 596 € | 577 € | 676 € | 372 € | 509 €    | FM-M2<br>PD-F0                   | 1     | 1  | 9.5  | 0.29 |
| <b>Chair SONNY S L TS_R</b><br><br><small>CATAS<br/>EN 1728</small>  | SI521WL_R | _R        | LF1   | 399 € | 457 € | 537 € | 567 € | 624 € | 605 € | 705 € | 399 € | 537 €    | PD-F0                            | 1     | 1  | 7.5  | 0.28 |
| <b>Chair SONNY S L TS_N</b><br>   | SI521WL_N | _N        | L11   | 506 € | 564 € | 644 € | 674 € | 731 € | 712 € | 812 € | 506 € | 644 €    | FL-I2<br>PD-F0                   | 1     | 1  | 7.5  | 0.28 |
| <b>Chair SONNY S MX TS</b><br><br>                   | SI520FX   | MX        | M1    | 520 € | 577 € | 658 € | 688 € | 746 € | 725 € | 826 € | 520 € | 658 €    | FM-M2                            | 1     | 1  | 11   | 0.28 |
| <b>Chair with self-return SONNY S X47 TS</b><br><br> | SI521YS   | X47       | M1    | 551 € | 610 € | 691 € | 720 € | 778 € | 757 € | 857 € | 551 € | 691 €    | FM-M2                            | 1     | 1  | 10.5 | 0.25 |
| <b>Office Chair SONNY DS TS</b><br><br>              | SI520DT   | DS        | M1    | 561 € | 616 € | 696 € | 726 € | 783 € | 765 € | 866 € | 561 € | 696 €    | FM-M2                            | 1     | 2  | 11   | 0.26 |

**Note:**

TS Front and Back covering available in two-tone or bi-material. Reference price in the upper category



**Frame finishes**

| Metal     |   | Wood       |  |
|-----------|---|------------|--|
| <b>MI</b> | WHITE <b>BB</b> , BROWN <b>E6</b> , SAND <b>EC</b> , WHITE PEARL <b>EF</b> , GRAPHITE <b>EG</b> , BLACK <b>EN</b> | <b>LFI</b> | Ash wood stained BLACK <b>F04</b> , Ash wood stained WHITE <b>F05</b> , Ash wood stained CHERRY RED <b>F09</b> , Ash wood stained FLAMED WALNUT <b>F24</b> , Ash wood stained DARK BROWN <b>F26</b> , Ash wood stained NATURAL <b>F40</b> , Ash wood stained NATURAL OAK <b>F52</b> , Ash wood stained WHITENED <b>F60</b> , Ash wood stained DESERT <b>F61</b> , Ash wood stained LIGHT GREY <b>F62</b> , Ash wood stained DARK GREY <b>F63</b>       |
|           |   | <b>LII</b> | Veneered wood painted BLACK <b>I04</b> , Veneered wood painted WHITE <b>I05</b> , Veneered wood painted CHERRY RED <b>I09</b> , Veneered wood painted DARK BROWN <b>I26</b> , Veneered wood painted NATURAL <b>I40</b> , Veneered wood painted NATURAL OAK <b>I52</b> , Veneered wood painted WHITENED <b>I60</b> , Veneered wood painted DESERT <b>I61</b> , Veneered wood painted LIGHT GREY <b>I62</b> , Veneered wood painted DARK GREY <b>I63</b> |

**Shell finishes**

| Upholstery |   |
|------------|---|
| <b>TA</b>  | FAUX LEATHER <b>Secret</b> , FABRIC <b>Mirage</b> , FABRIC <b>Cotton Club</b> , FABRIC <b>Renewed Loop</b>  |
| <b>TC</b>  | VELVET SUPERB, FABRIC <b>Second</b> , FABRIC <b>Main Line Flax</b> , FABRIC <b>Oceanic</b> , FABRIC <b>Jumper</b> , FABRIC <b>Flame</b> , FABRIC <b>Ouche</b> , FABRIC <b>Plain</b> , FABRIC <b>Gemma</b> , FABRIC <b>Caltagirone 114</b> |
| <b>TE</b>  | FABRIC <b>Uniform Melange</b>   |
| <b>SV</b>  | LEATHER <b>Vintage</b>  |
| <b>TB</b>  | FAUX LEATHER <b>Vintage</b> , FABRIC <b>Fenix Wool</b> , FABRIC <b>Visual</b> , FABRIC <b>Manhattan</b> , FABRIC <b>Novabuk</b> , FABRIC <b>Network</b> , FABRIC <b>Gyre</b>  |
| <b>TD</b>  | FABRIC <b>Yoredale</b> , FABRIC <b>Remix 3</b>  |
| <b>SF</b>  | LEATHER <b>Fiore</b>  |

**COM/COL - Minimum Q.ty 6 pc. for each material. For weft or patterned fabrics see specific pages**

|  |                        |   |               |
|--|------------------------|---|---------------|
|  <b>COM</b> | Mtl. 1.10 h. 1.40 Each |  <b>COL</b> | Mq. 2.02 Each |
|--|------------------------|---|---------------|

**Optionals:**

|              | Value   | Options/notes  |
|--------------|---------|--|
| <b>FM-M2</b> | + 48 €  | ASH GREY <b>ES</b> , BLUE SAPPHIRE <b>EE</b> , BLUE TURQUOISE <b>EH</b> , BRONZE <b>E2</b> , BULGARO RED <b>FP</b> , CHERRY RED <b>EQ</b> , DARK GREEN <b>EL</b> , FACEPOWDER PINK <b>E8</b> , FANGO <b>E3</b> , GOLDEN YELLOW <b>EO</b> , LIGHT BLUE <b>EO</b> , LIGHT GREY <b>ET</b> , OCEAN BLUE <b>E1</b> , OCHER YELLOW <b>E7</b> , PAPAYA ORANGE <b>EA</b> , PASTEL YELLOW <b>E4</b> , PINE GREEN <b>EJ</b> , RED <b>ER</b> , SAGE GREEN <b>E9</b> |
| <b>FM-M3</b> | + 21 €  | CHROME <b>CC</b>   |
| <b>FM-M4</b> | + 108 € | BLACK NICKEL <b>DZ</b> , CHAMPAGNE GOLD <b>DG</b> , GOLDEN BRONZE <b>DB</b> , MATT BLACK NICKEL <b>DY</b> , MATT GOLDEN BRONZE <b>DC</b> , PINK GOLD <b>DR</b>   |
| <b>FL-I2</b> | + 8 €   | Veneered wood FLAMED WALNUT <b>I24</b> , Veneered wood NATURAL OAK <b>I22</b>  |
| <b>PD-F0</b> | + 6 €   | PD-F0  |

**Sonny S\_M**

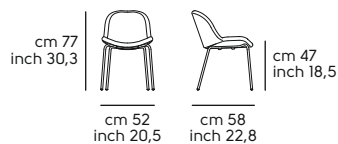

**Sonny S\_Q**

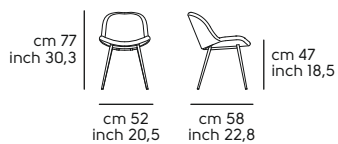

**Sonny S\_R**

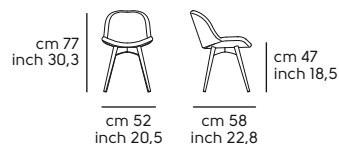

**Sonny S\_N**

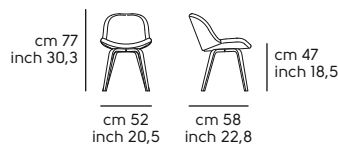

**Sonny S\_MX**

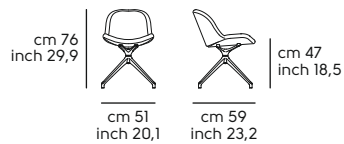

**Sonny S\_X47**

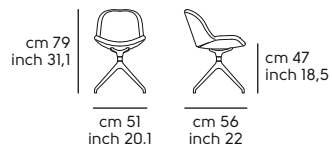



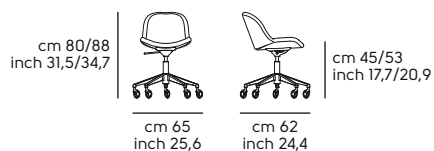



**Sonny S\_DS**



**Sonny PB - Shell in fabric or leather**

Frame in: metal or wood

| Model   | Code      | Base type | Frame | Shell |       |       |       |       |       |         |       |       | Optional                         | Q.ty | boxes | Kg    | M <sup>3</sup> |
|---|-----------|-----------|-------|-------|-------|-------|-------|-------|-------|---------|-------|-------|----------------------------------|------|-------|-------|----------------|
|   |           |           |       | TA    | TB    | TC    | TD    | TE    | SF    | SV      | COM   | COL   |                                  |      |       |       |                |
|  <p><b>Armchair SONNY PB M TS_M</b></p>                  | S1521PT_M | _M        | M1    | 386 € | 431 € | 511 € | 526 € | 678 € | 613 € | 754 €   | 386 € | 511 € | FM-M2<br>FM-M3<br>FM-M4<br>PD-F0 | 1    | 1     | 7     | 0.31           |
|  <p><b>Armchair SONNY PB M TS_Q</b></p>                  | S1521PT_Q | _Q        | M1    | 440 € | 485 € | 565 € | 580 € | 732 € | 667 € | 808 €   | 440 € | 565 € | FM-M2<br>PD-F0                   | 1    | 1     | 9.5   | 0.31           |
|  <p><b>Armchair SONNY PB L TS_R</b></p>                  | S1521PW_R | _R        | LF1   | 465 € | 510 € | 583 € | 606 € | 758 € | 693 € | 833 €   | 465 € | 583 € | PD-F0                            | 1    | 1     | 7     | 0.31           |
|  <p><b>Armchair SONNY PB L TS_N</b></p>                 | S1521PW_N | _N        | L11   | 572 € | 617 € | 690 € | 713 € | 865 € | 800 € | 940 €   | 572 € | 690 € | FL-I2<br>PD-F0                   | 1    | 1     | 7     | 0.31           |
|  <p><b>Armchair SONNY PB MX TS</b></p>                 | S1520QY   | MX        | M1    | 588 € | 632 € | 712 € | 728 € | 879 € | 812 € | 955 €   | 588 € | 712 € | FM-M2                            | 1    | 1     | 12    | 0.32           |
|  <p><b>Armch. with self-return SONNY PB X47 TS</b></p> | S1521YQ   | X47       | M1    | 619 € | 664 € | 737 € | 760 € | 912 € | 846 € | 986 €   | 619 € | 737 € | FM-M2                            | 1    | 1     | 11.35 | 0.30           |
|  <p><b>Office Arm. SONNY DPB TS</b></p>                | S1520ET   | DPB       | M1    | 688 € | 732 € | 806 € | 829 € | 981 € | 914 € | 1.054 € | 688 € | 806 € | FM-M2                            | 1    | 2     | 12    | 0.30           |

**Note:**

TS Front and Back covering available in two-tone or bi-material. Reference price in the upper category



**Frame finishes**

| Metal     |   | Wood       |  |
|-----------|---|------------|--|
| <b>MI</b> | WHITE <b>BB</b> , BROWN <b>E6</b> , SAND <b>EC</b> , WHITE PEARL <b>EF</b> , GRAPHITE <b>EG</b> , BLACK <b>EN</b> | <b>LFI</b> | Ash wood stained BLACK <b>F04</b> , Ash wood stained WHITE <b>F05</b> , Ash wood stained CHERRY RED <b>F09</b> , Ash wood stained FLAMED WALNUT <b>F24</b> , Ash wood stained DARK BROWN <b>F26</b> , Ash wood stained NATURAL <b>F40</b> , Ash wood stained NATURAL OAK <b>F52</b> , Ash wood stained WHITENED <b>F60</b> , Ash wood stained DESERT <b>F61</b> , Ash wood stained LIGHT GREY <b>F62</b> , Ash wood stained DARK GREY <b>F63</b>       |
|           |   | <b>LII</b> | Veneered wood painted BLACK <b>I04</b> , Veneered wood painted WHITE <b>I05</b> , Veneered wood painted CHERRY RED <b>I09</b> , Veneered wood painted DARK BROWN <b>I26</b> , Veneered wood painted NATURAL <b>I40</b> , Veneered wood painted NATURAL OAK <b>I52</b> , Veneered wood painted WHITENED <b>I60</b> , Veneered wood painted DESERT <b>I61</b> , Veneered wood painted LIGHT GREY <b>I62</b> , Veneered wood painted DARK GREY <b>I63</b> |

**Shell finishes**

| Upholstery |   |
|------------|---|
| <b>TA</b>  | FAUX LEATHER <b>Secret</b> , FABRIC <b>Mirage</b> , FABRIC <b>Cotton Club</b> , FABRIC <b>Renewed Loop</b>  |
| <b>TC</b>  | VELVET SUPERB, FABRIC <b>Second</b> , FABRIC <b>Main Line Flax</b> , FABRIC <b>Oceanic</b> , FABRIC <b>Jumper</b> , FABRIC <b>Flame</b> , FABRIC <b>Ouche</b> , FABRIC <b>Plain</b> , FABRIC <b>Gemma</b> , FABRIC <b>Callagirone 114</b> |
| <b>TE</b>  | FABRIC <b>Uniform Melange</b>   |
| <b>SV</b>  | LEATHER <b>Vintage</b>  |
| <b>TB</b>  | FAUX LEATHER <b>Vintage</b> , FABRIC <b>Fenix Wool</b> , FABRIC <b>Visual</b> , FABRIC <b>Manhattan</b> , FABRIC <b>Novabuk</b> , FABRIC <b>Network</b> , FABRIC <b>Gyre</b>  |
| <b>TD</b>  | FABRIC <b>Yoredale</b> , FABRIC <b>Remix 3</b>  |
| <b>SF</b>  | LEATHER <b>Fiore</b>  |

**COM/COL - Minimum Q.ty 6 pc. for each material. For weft or patterned fabrics see specific pages**

|  |                        |   |               |
|--|------------------------|---|---------------|
|  <b>COM</b> | Mtl. 1.50 h. 1.40 Each |  <b>COL</b> | Mq. 2.74 Each |
|--|------------------------|---|---------------|

**Optionals:**

|              |                          | Value   | Options/notes  |
|--------------|--------------------------|---------|--|
| <b>FM-M2</b> | Indoor matt metal M2     | + 48 €  | ASH GREY <b>ES</b> , BLUE SAPPHIRE <b>EE</b> , BLUE TURQUOISE <b>EH</b> , BRONZE <b>E2</b> , BULGARO RED <b>FP</b> , CHERRY RED <b>EQ</b> , DARK GREEN <b>EL</b> , FACEPOWDER PINK <b>E8</b> , FANGO <b>E3</b> , GOLDEN YELLOW <b>EO</b> , LIGHT BLUE <b>EO</b> , LIGHT GREY <b>ET</b> , OCEAN BLUE <b>EI</b> , OCHER YELLOW <b>E7</b> , PAPAYA ORANGE <b>EA</b> , PASTEL YELLOW <b>E4</b> , PINE GREEN <b>EJ</b> , RED <b>ER</b> , SAGE GREEN <b>E9</b> |
| <b>FM-M3</b> | Indoor glossy metal M3   | + 21 €  | CHROME <b>CC</b>   |
| <b>FM-M4</b> | Indoor glossy Metal M4   | + 108 € | BLACK NICKEL <b>DZ</b> , CHAMPAGNE GOLD <b>DG</b> , GOLDEN BRONZE <b>DB</b> , MATT BLACK NICKEL <b>DY</b> , MATT GOLDEN BRONZE <b>DC</b> , PINK GOLD <b>DR</b>   |
| <b>FL-I2</b> | Veneered wood finish LI2 | + 8 €   | Veneered wood FLAMED WALNUT <b>I24</b> , Veneered wood NATURAL OAK <b>I22</b>  |
| <b>PD-F0</b> | Felt pad feet            | + 6 €   | PD-F0  |

**Sonny PB\_M**

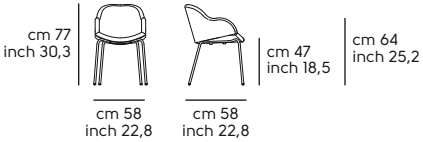

**Sonny PB\_Q**

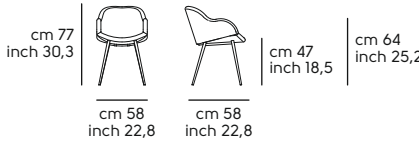

**Sonny PB\_R**

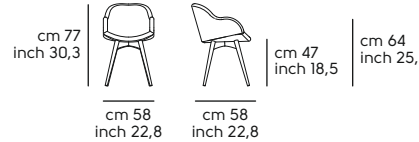

**Sonny PB\_N**

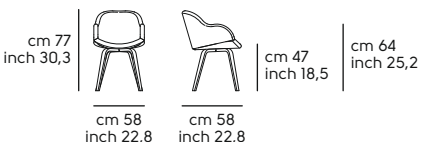

**Sonny PB\_MX**

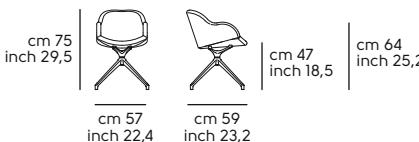

**Sonny PB\_X47**

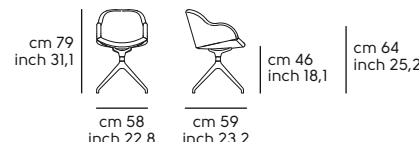



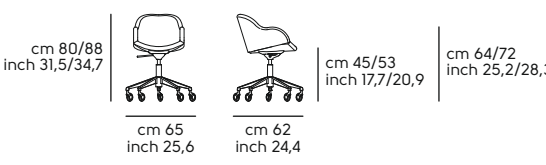



**Sonny PB\_DPB**



**Sonny P - Shell in fabric or leather**

Frame in: metal or wood

| Model  | Code      | Base type | Frame | Shell |       |       |       |       |       |         |       |       | Optional                         | Q.ty | boxes | Kg   | M³   |
|--|-----------|-----------|-------|-------|-------|-------|-------|-------|-------|---------|-------|-------|----------------------------------|------|-------|------|------|
|  |           |           |       | TA    | TB    | TC    | TD    | TE    | SF    | SV      | COM   | COL   |                                  |      |       |      |      |
|  <p><b>Armchair SONNY P M TS_M</b></p>                  | S1521QT_M | _M        | M1    | 401 € | 480 € | 520 € | 543 € | 694 € | 639 € | 776 €   | 401 € | 520 € | FM-M2<br>FM-M3<br>FM-M4<br>PD-F0 | 1    | 1     | 7    | 0.31 |
|  <p><b>Armchair SONNY P M TS_Q</b></p>                  | S1521QT_Q | _Q        | M1    | 453 € | 532 € | 572 € | 595 € | 746 € | 691 € | 828 €   | 453 € | 572 € | FM-M2<br>PD-F0                   | 1    | 1     | 10   | 0.31 |
|  <p><b>Armchair SONNY P L TS_R</b></p>                  | S1521QW_R | _R        | LF1   | 494 € | 572 € | 612 € | 634 € | 785 € | 732 € | 869 €   | 494 € | 612 € | PD-F0                            | 1    | 1     | 9.5  | 0.33 |
|  <p><b>Armchair SONNY P L TS_N</b></p>                 | S1521QW_N | _N        | L11   | 589 € | 667 € | 707 € | 729 € | 880 € | 827 € | 964 €   | 589 € | 707 € | FL-I2<br>PD-F0                   | 1    | 1     | 9.5  | 0.33 |
|  <p><b>Armchair SONNY P MX TS</b></p>                 | S1520QX   | MX        | M1    | 602 € | 681 € | 721 € | 743 € | 894 € | 838 € | 977 €   | 602 € | 721 € | FM-M2                            | 1    | 1     | 13   | 0.32 |
|  <p><b>Armch. with self-return SONNY P X47 TS</b></p> | S1521YP   | X47       | M1    | 634 € | 713 € | 754 € | 776 € | 926 € | 870 € | 1.008 € | 634 € | 754 € | FM-M2                            | 1    | 1     | 11.5 | 0.30 |
|  <p><b>Office Arm. SONNY DP TS</b></p>                | S1520ED   | DP        | M1    | 703 € | 782 € | 822 € | 867 € | 995 € | 939 € | 1.076 € | 703 € | 822 € | FM-M2                            | 1    | 2     | 13   | 0.30 |

**Note:**

TS Front and Back covering available in two-tone or bi-material. Reference price in the upper category



**Frame finishes**

| Metal     |   | Wood       |  |
|-----------|---|------------|--|
| <b>MI</b> | WHITE <b>BB</b> , BROWN <b>E6</b> , SAND <b>EC</b> , WHITE PEARL <b>EF</b> , GRAPHITE <b>EG</b> , BLACK <b>EN</b> | <b>LFI</b> | Ash wood stained BLACK <b>F04</b> , Ash wood stained WHITE <b>F05</b> , Ash wood stained CHERRY RED <b>F09</b> , Ash wood stained FLAMED WALNUT <b>F24</b> , Ash wood stained DARK BROWN <b>F26</b> , Ash wood stained NATURAL <b>F40</b> , Ash wood stained NATURAL OAK <b>F52</b> , Ash wood stained WHITENED <b>F60</b> , Ash wood stained DESERT <b>F61</b> , Ash wood stained LIGHT GREY <b>F62</b> , Ash wood stained DARK GREY <b>F63</b>       |
|           |   | <b>LII</b> | Veneered wood painted BLACK <b>I04</b> , Veneered wood painted WHITE <b>I05</b> , Veneered wood painted CHERRY RED <b>I09</b> , Veneered wood painted DARK BROWN <b>I26</b> , Veneered wood painted NATURAL <b>I40</b> , Veneered wood painted NATURAL OAK <b>I52</b> , Veneered wood painted WHITENED <b>I60</b> , Veneered wood painted DESERT <b>I61</b> , Veneered wood painted LIGHT GREY <b>I62</b> , Veneered wood painted DARK GREY <b>I63</b> |

**Shell finishes**

| Upholstery |   |
|------------|---|
| <b>TA</b>  | FAUX LEATHER <b>Secret</b> , FABRIC <b>Mirage</b> , FABRIC <b>Cotton Club</b> , FABRIC <b>Renewed Loop</b>  |
| <b>TC</b>  | VELVET SUPERB, FABRIC <b>Second</b> , FABRIC <b>Main Line Flax</b> , FABRIC <b>Oceanic</b> , FABRIC <b>Jumper</b> , FABRIC <b>Flame</b> , FABRIC <b>Ouche</b> , FABRIC <b>Plain</b> , FABRIC <b>Gemma</b> , FABRIC <b>Caltagirone 114</b> |
| <b>TE</b>  | FABRIC <b>Uniform Melange</b>   |
| <b>SV</b>  | LEATHER <b>Vintage</b>  |
| <b>TB</b>  | FAUX LEATHER <b>Vintage</b> , FABRIC <b>Fenix Wool</b> , FABRIC <b>Visual</b> , FABRIC <b>Manhattan</b> , FABRIC <b>Novabuk</b> , FABRIC <b>Network</b> , FABRIC <b>Gyre</b>  |
| <b>TD</b>  | FABRIC <b>Yoredale</b> , FABRIC <b>Remix 3</b>  |
| <b>SF</b>  | LEATHER <b>Fiore</b>  |

**COM/COL - Minimum Q.ty 6 pc. for each material. For weft or patterned fabrics see specific pages**

|  |                        |   |               |
|--|------------------------|---|---------------|
|  <b>COM</b> | Mtl. 1.50 h. 1.40 Each |  <b>COL</b> | Mq. 2.60 Each |
|--|------------------------|---|---------------|

**Optionals:**

|              |                          | Value   | Options/notes  |
|--------------|--------------------------|---------|--|
| <b>FM-M2</b> | Indoor matt metal M2     | + 48 €  | ASH GREY <b>ES</b> , BLUE SAPPHIRE <b>EE</b> , BLUE TURQUOISE <b>EH</b> , BRONZE <b>E2</b> , BULGARO RED <b>FP</b> , CHERRY RED <b>EQ</b> , DARK GREEN <b>EL</b> , FACEPOWDER PINK <b>E8</b> , FANGO <b>E3</b> , GOLDEN YELLOW <b>EO</b> , LIGHT BLUE <b>EO</b> , LIGHT GREY <b>ET</b> , OCEAN BLUE <b>EI</b> , OCHER YELLOW <b>E7</b> , PAPAYA ORANGE <b>EA</b> , PASTEL YELLOW <b>E4</b> , PINE GREEN <b>EJ</b> , RED <b>ER</b> , SAGE GREEN <b>E9</b> |
| <b>FM-M3</b> | Indoor glossy metal M3   | + 21 €  | CHROME <b>CC</b>   |
| <b>FM-M4</b> | Indoor glossy Metal M4   | + 108 € | BLACK NICKEL <b>DZ</b> , CHAMPAGNE GOLD <b>DG</b> , GOLDEN BRONZE <b>DB</b> , MATT BLACK NICKEL <b>DY</b> , MATT GOLDEN BRONZE <b>DC</b> , PINK GOLD <b>DR</b>   |
| <b>FL-I2</b> | Veneered wood finish LI2 | + 8 €   | Veneered wood FLAMED WALNUT <b>I24</b> , Veneered wood NATURAL OAK <b>I22</b>  |
| <b>PD-F0</b> | Felt pad feet            | + 6 €   | PD-F0  |

**Sonny P\_M**

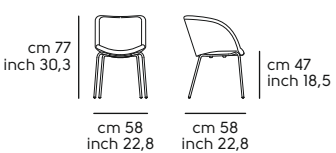

**Sonny P\_Q**

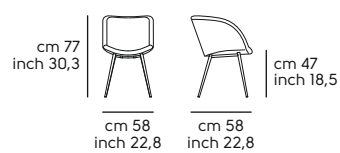

**Sonny P\_R**



**Sonny P\_N**

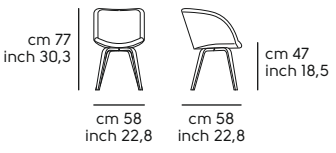

**Sonny P\_MX**

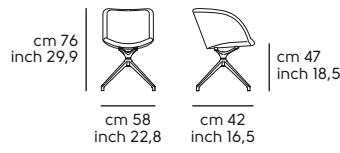

**Sonny P\_X47**

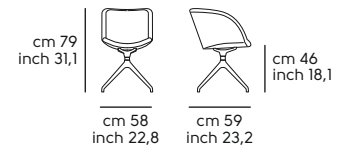

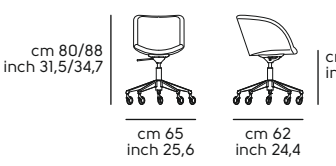

**Sonny P\_DP**



## Sonny H65-75 - Shell in fabric or leather

Frame in: metal

| Model   | Code    | Mod. | Frame | Shell |       |       |       |       |       |       |       |       | Optional       | Q.ty | boxes | Kg  | M³   |
|---|---------|------|-------|-------|-------|-------|-------|-------|-------|-------|-------|-------|----------------|------|-------|-----|------|
|   |         |      |       | TA    | TB    | TC    | TD    | TE    | SF    | SV    | COM   | COL   |                |      |       |     |      |
|  <b>Stool SONNY H65 M TS</b> | S1520IT | H65  | MI    | 464 € | 521 € | 601 € | 629 € | 686 € | 670 € | 769 € | 464 € | 601 € | FM-M2<br>PD-F0 | 1    | 1     | 9.5 | 0.34 |
|  <b>Stool SONNY H75 M TS</b> | S1520KT | H75  | MI    | 479 € | 536 € | 616 € | 645 € | 702 € | 684 € | 783 € | 479 € | 616 € | FM-M2<br>PD-F0 | 1    | 1     | 10  | 0.38 |

**Note:**

TS Front and Back covering available in two-tone or bi-material. Reference price in the upper category

### Frame finishes

**Metal**



**MI** WHITE **BB**, BROWN **E6**, SAND **EC**, WHITE PEARL **EF**, GRAPHITE **EG**, BLACK **EN**

### Shell finishes

**Upholstery**

|           |   |           |  |
|-----------|---|-----------|--|
| <b>TA</b> | FAUX LEATHER <b>Secret</b> , FABRIC <b>Mirage</b> , FABRIC <b>Cotton Club</b> , FABRIC <b>Renewed Loop</b>  | <b>TB</b> | FAUX LEATHER <b>Vintage</b> , FABRIC <b>Fenix Wool</b> , FABRIC <b>Visual</b> , FABRIC <b>Manhattan</b> , FABRIC <b>Novabuk</b> , FABRIC <b>Network</b> , FABRIC <b>Gyre</b> |
| <b>TC</b> | VELVET SUPERB, FABRIC <b>Second</b> , FABRIC <b>Main Line Flax</b> , FABRIC <b>Oceanic</b> , FABRIC <b>Jumper</b> , FABRIC <b>Flame</b> , FABRIC <b>Ouche</b> , FABRIC <b>Plain</b> , FABRIC <b>Gemma</b> , FABRIC <b>Caltagirone II4</b> | <b>TD</b> | FABRIC <b>Yoredale</b> , FABRIC <b>Remix 3</b>   |
| <b>TE</b> | FABRIC <b>Uniform Melange</b>   | <b>SF</b> | LEATHER <b>Fiore</b>   |
| <b>SV</b> | LEATHER <b>Vintage</b>  |           |  |

**COM/COL - Minimum Q.ty 6 pc. for each material. For weft or patterned fabrics see specific pages**

|  |                        |  |               |
|--|------------------------|--|---------------|
|  <b>COM</b> | Mtl. 1.10 h. 1.40 Each |  <b>COL</b> | Mq. 2.02 Each |
|--|------------------------|--|---------------|

### Optionals:

|              | Value  | Options/notes  |
|--------------|--------|--|
| <b>FM-M2</b> | + 48 € | ASH GREY <b>ES</b> , BLUE SAPPHIRE <b>EE</b> , BLUE TURQUOISE <b>EH</b> , BRONZE <b>E2</b> , BULGARO RED <b>FP</b> , CHERRY RED <b>EQ</b> , DARK GREEN <b>EL</b> , FACEPOWDER PINK <b>E8</b> , FANGO <b>E3</b> , GOLDEN YELLOW <b>EO</b> , LIGHT BLUE <b>EO</b> , LIGHT GREY <b>ET</b> , OCEAN BLUE <b>EI</b> , OCHER YELLOW <b>E7</b> , PAPAYA ORANGE <b>EA</b> , PASTEL YELLOW <b>E4</b> , PINE GREEN <b>EJ</b> , RED <b>ER</b> , SAGE GREEN <b>E9</b> |
| <b>PD-F0</b> | + 6 €  | PD-F0  |

### Sonny H65

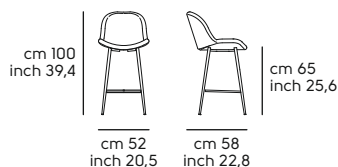

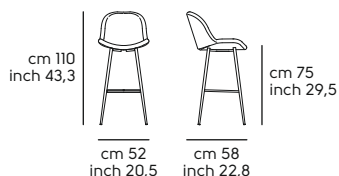

### Sonny H75



## Sonny H65-75 - Shell in fabric or leather

Frame in: wood

| Model   | Code    | Mod. | Frame | Shell |       |       |       |       |       |       |       |       | Optional | Q.ty<br> | boxes<br> | Kg<br> | M³<br> |
|---|---------|------|-------|-------|-------|-------|-------|-------|-------|-------|-------|-------|----------|----------|-----------|--------|--------|
|   |         |      |       | TA    | TB    | TC    | TD    | TE    | SF    | SV    | COM   | COL   |          |          |           |        |        |
|  <b>Stool SONNY H65 LR TS</b> | S1520IW | H65  | LFI   | 532 € | 590 € | 670 € | 698 € | 756 € | 738 € | 837 € | 532 € | 670 € | PD-F0    | 1        | 1         | 8.9    | 0.30   |
|  <b>Stool SONNY H75 LR TS</b> | S1520KW | H75  | LFI   | 552 € | 609 € | 690 € | 718 € | 776 € | 758 € | 856 € | 552 € | 690 € | PD-F0    | 1        | 1         | 10.15  | 0.33   |

### Note:

TS Front and Back covering available in two-tone or bi-material. Reference price in the upper category

### Frame finishes

#### Wood

##### LFI



Ash wood stained BLACK **F04**, Ash wood stained WHITE **F05**, Ash wood stained CHERRY RED **F09**, Ash wood stained FLAMED WALNUT **F24**, Ash wood stained DARK BROWN **F26**, Ash wood stained NATURAL **F40**, Ash wood stained NATURAL OAK **F52**, Ash wood stained WHITENED **F60**, Ash wood stained DESERT **F61**, Ash wood stained LIGHT GREY **F62**, Ash wood stained DARK GREY **F63**

### Shell finishes

#### Upholstery

|           |   |           |  |
|-----------|---|-----------|--|
| <b>TA</b> | FAUX LEATHER <b>Secret</b> , FABRIC <b>Mirage</b> , FABRIC <b>Cotton Club</b> , FABRIC <b>Renewed Loop</b>  | <b>TB</b> | FAUX LEATHER <b>Vintage</b> , FABRIC <b>Fenix Wool</b> , FABRIC <b>Visual</b> , FABRIC <b>Manhattan</b> , FABRIC <b>Novabuk</b> , FABRIC <b>Network</b> , FABRIC <b>Gyre</b> |
| <b>TC</b> | VELVET SUPERB, FABRIC <b>Second</b> , FABRIC <b>Main Line Flax</b> , FABRIC <b>Oceanic</b> , FABRIC <b>Jumper</b> , FABRIC <b>Flame</b> , FABRIC <b>Ouche</b> , FABRIC <b>Plain</b> , FABRIC <b>Gemma</b> , FABRIC <b>Caltagirone 114</b> | <b>TD</b> | FABRIC <b>Yoredale</b> , FABRIC <b>Remix 3</b>   |
| <b>TE</b> | FABRIC <b>Uniform Melange</b>   | <b>SF</b> | LEATHER <b>Fiore</b>   |
| <b>SV</b> | LEATHER <b>Vintage</b>  |           |  |

**COM/COL - Minimum Q.ty 6 pc. for each material. For weft or patterned fabrics see specific pages**

|   |                        |  |               |
|---|------------------------|--|---------------|
|  <b>COM</b> | Mtl. 1.10 h. 1.40 Each |  <b>COL</b> | Mq. 2.02 Each |
|---|------------------------|--|---------------|

### Optionals:

|              | Value         | Options/notes |
|--------------|---------------|---------------|
| <b>PD-F0</b> | Felt pad feet | + 6 € PD-F0   |

#### Sonny H65 LR

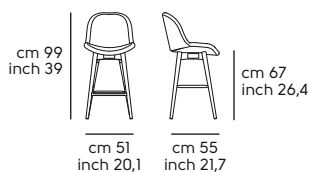



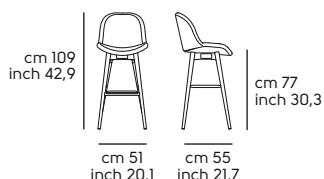

#### Sonny H75 LR



## Sonny SG - Shell in fabric or leather

Frame in: metal

| Model  | Code    | Mod. | Frame | Shell |       |       |       |       |       |         |       |       | Optional | Q.ty | boxes | Kg   | M³   |
|--|---------|------|-------|-------|-------|-------|-------|-------|-------|---------|-------|-------|----------|------|-------|------|------|
|  |         |      |       | TA    | TB    | TC    | TD    | TE    | SF    | SV      | COM   | COL   |          |      |       |      |      |
| <br> | S1520ZT | SG   | M3    | 581 € | 638 € | 718 € | 747 € | 804 € | 786 € | 886 €   | 581 € | 718 € |          | 1    | 1     | 17   | 0.32 |
| <br> | S1520ZT | SG   | M1    | 739 € | 796 € | 876 € | 905 € | 962 € | 944 € | 1.044 € | 739 € | 876 € | FM-M2    | 1    | 1     | 17.7 | 0.29 |

**Note:**

TS Front and Back covering available in two-tone or bi-material. Reference price in the upper category

**Frame finishes**

**Metal**

**M3** CHROME CC

**Frame finishes**

**Metal**



**M1** WHITE BB, BROWN E6, SAND EC, WHITE PEARL EF, GRAPHITE EG, BLACK EN

**Shell finishes**

**Upholstery**

|           |   |           |  |
|-----------|---|-----------|--|
| <b>TA</b> | FAUX LEATHER <b>Secret</b> , FABRIC <b>Mirage</b> , FABRIC <b>Cotton Club</b> , FABRIC <b>Renewed Loop</b>  | <b>TB</b> | FAUX LEATHER <b>Vintage</b> , FABRIC <b>Fenix Wool</b> , FABRIC <b>Visual</b> , FABRIC <b>Manhattan</b> , FABRIC <b>Novabuk</b> , FABRIC <b>Network</b> , FABRIC <b>Gyre</b> |
| <b>TC</b> | VELVET SUPERB, FABRIC <b>Second</b> , FABRIC <b>Main Line Flax</b> , FABRIC <b>Oceanic</b> , FABRIC <b>Jumper</b> , FABRIC <b>Flame</b> , FABRIC <b>Ouche</b> , FABRIC <b>Plain</b> , FABRIC <b>Gemma</b> , FABRIC <b>Cattagirone 114</b> | <b>TD</b> | FABRIC <b>Yoredale</b> , FABRIC <b>Remix 3</b>   |
| <b>TE</b> | FABRIC <b>Uniform Melange</b>   | <b>SF</b> | LEATHER <b>Fiore</b>   |
| <b>SV</b> | LEATHER <b>Vintage</b>  |           |  |

COM/COL - Minimum Q.ty 6 pc. for each material. For weft or patterned fabrics see specific pages

|  |   |
|--|---|
|  Mtl. 1.10 h. 1.40 Each |  Mq. 2.02 Each |
|--|---|

**Optionals:**

|              | Value  | Options/notes  |
|--------------|--------|--|
| <b>FM-M2</b> | + 58 € | ASH GREY <b>ES</b> , BLUE SAPPHIRE <b>EE</b> , BLUE TURQUOISE <b>EH</b> , BRONZE <b>E2</b> , BULGARO RED <b>FP</b> , CHERRY RED <b>EQ</b> , DARK GREEN <b>EL</b> , FACEPOWDER PINK <b>E8</b> , FANGO <b>E3</b> , GOLDEN YELLOW <b>EO</b> , LIGHT BLUE <b>EO</b> , LIGHT GREY <b>ET</b> , OCEAN BLUE <b>EI</b> , OCHER YELLOW <b>E7</b> , PAPAYA ORANGE <b>EA</b> , PASTEL YELLOW <b>E4</b> , PINE GREEN <b>EJ</b> , RED <b>ER</b> , SAGE GREEN <b>E9</b> |

**Sonny SG**

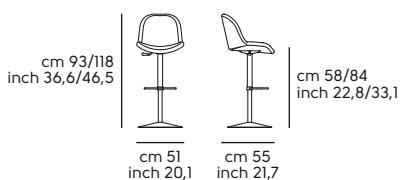



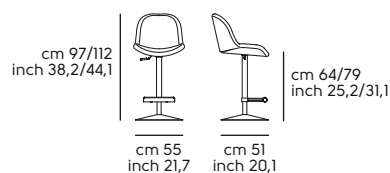

**Sonny SG\_Toy**



# Stack design Martini & Dall'Agnol



## Stack S PP - Polypropylene shell

Frame in: polypropylene

| Model   | Code     | Mod. | Frame | Shell |       | Optional | Q.ty | boxes | Kg   | M <sup>3</sup> |
|---|----------|------|-------|-------|-------|----------|------|-------|------|----------------|
|   |          |      |       | PP1   | PP3   |          |      |       |      |                |
| <b>Chair STACK S PP</b><br>    | S2270SP1 | S    | PP1   | 152 € | 164 € | PD-F0    | 4    | 1     | 21.2 | 0.347          |



## Stack S PP\_LG - Wood shell

Frame in: polypropylene

| Model  | Code     | Mod. | Frame | Shell |       | Optional | Q.ty | boxes | Kg   | M <sup>3</sup> |
|--|----------|------|-------|-------|-------|----------|------|-------|------|----------------|
|  |          |      |       | LI1   | LI2   |          |      |       |      |                |
| <b>Chair STACK S PP_LG</b><br>   | S2270SL1 | S    | PP1   | 338 € | 366 € | PD-F0    | 4    | 1     | 27.6 | 0.347          |



## Stack S PP\_CU - Shell in hide

Frame in: polypropylene



| Model  | Code     | Mod. | Frame | Shell |       | Optional      | Q.ty | boxes | Kg   | M <sup>3</sup> |
|--|----------|------|-------|-------|-------|---------------|------|-------|------|----------------|
|  |          |      |       | CU    | CT    |               |      |       |      |                |
| <b>Chair STACK S PP_CU</b><br>   | S2270SC1 | S    | PP1   | 400 € | 473 € | ES-1<br>PD-F0 | 4    | 1     | 24.0 | 0.347          |



**Stack S PP\_TS - S PP\_SD - Shell - seat fabric or leather**

Frame in: polypropylene



| Model   | Code     | Mod. | Frame | Shell |       |       |       |       |       |       |       |       |               | Optional | Q.ty | boxes | Kg    | M³ |
|---|----------|------|-------|-------|-------|-------|-------|-------|-------|-------|-------|-------|---------------|----------|------|-------|-------|----|
|   |          |      |       | TA    | TB    | TC    | TD    | TE    | SF    | SV    | COM   | COL   |               |          |      |       |       |    |
| <br><br> | S2270STI | S    | PP1   | 290 € | 304 € | 330 € | 347 € | 460 € | 352 € | 414 € | 290 € | 330 € | ES-1<br>PD-F0 | 4        | 1    | 24.0  | 0.347 |    |

**COM/COL - Minimum Q.ty 6 pc. for each material. For weft or patterned fabrics see specific pages**

|  |   |
|--|---|
|  Mtl. 0.80 h. 1.40 Each |  Mq. 1.10 Each |
|--|---|

| Model   | Code     | Mod. | Frame and Shell | Cushion |       |       |       |       |       |       |       |       |               | Optional | Q.ty | boxes | Kg    | M³ |
|---|----------|------|-----------------|---------|-------|-------|-------|-------|-------|-------|-------|-------|---------------|----------|------|-------|-------|----|
|   |          |      |                 | TA      | TB    | TC    | TD    | TE    | SF    | SV    | COM   | COL   |               |          |      |       |       |    |
| <br><br> | S2270SSI | S    | PP1             | 245 €   | 253 € | 262 € | 271 € | 323 € | 266 € | 297 € | 245 € | 262 € | ES-1<br>PD-F0 | 4        | 1    | 22.8  | 0.347 |    |

**COM/COL - Minimum Q.ty 6 pc. for each material. For weft or patterned fabrics see specific pages**

|  |   |
|--|---|
|  Mtl. 0.49 h. 1.40 Each |  Mq. 0.35 Each |
|--|---|

| Model   | Code      | Mod. | - | Upholstery |       | Optional | Q.ty | boxes | Kg  | M³   |
|---|-----------|------|---|------------|-------|----------|------|-------|-----|------|
|   |           |      |   | TB         | TE    |          |      |       |     |      |
|  | S2270CPT0 |      |   | 81 €       | 198 € |          | 4    | 1     | 3.2 | 0.04 |

**Note:**  
Available only fabric Network or Uniform Melange

**Note:**  
Linking device and STACK CART see Accessories section.

**Frame and shell finishes**

**Polypropylene**

|            |  |
|------------|--|
| <b>PP1</b> | WHITE <b>PB4</b> , GRAFITE GREY <b>PGD</b> , SKY GREY <b>PGU</b> , BLACK <b>PN4</b> , OCHER YELLOW <b>PO2</b> , RED BULGARO <b>PRS</b> , SAND <b>PS2</b> , DARK GREEN <b>PVL</b> |
|------------|--|

**Polypropylene Bicolor**

|            |  |
|------------|--|
| <b>PP3</b> | WHITE <b>PB4</b> , GRAFITE GREY <b>PGD</b> , SKY GREY <b>PGU</b> , BLACK <b>PN4</b> , OCHER YELLOW <b>PO2</b> , RED BULGARO <b>PRS</b> , SAND <b>PS2</b> , DARK GREEN <b>PVL</b> |
|------------|--|

**Shell finishes**

**Wood**

|            |  |            |   |
|------------|--|------------|---|
| <b>L11</b> | Veneered wood painted BLACK <b>I04</b> , Veneered wood painted WHITE <b>I05</b> , Veneered wood painted CHERRY RED <b>I09</b> , Veneered wood painted DARK BROWN <b>I26</b> , Veneered wood painted NATURAL <b>I40</b> , Veneered wood painted NATURAL OAK <b>I52</b> , Veneered wood painted WHITENED <b>I60</b> , Veneered wood painted DESERT <b>I61</b> , Veneered wood painted LIGHT GREY <b>I62</b> , Veneered wood painted DARK GREY <b>I63</b> | <b>L12</b> | Veneered wood NATURAL OAK <b>I22</b> , Veneered wood FLAMED WALNUT <b>I24</b> |
|------------|--|------------|---|

**Upholstery**

|           |   |           |  |
|-----------|---|-----------|--|
| <b>TA</b> | FAUX LEATHER <b>Secret</b> , FABRIC <b>Mirage</b> , FABRIC <b>Cotton Club</b> , FABRIC <b>Renewed Loop</b>  | <b>TB</b> | FAUX LEATHER <b>Vintage</b> , FABRIC <b>Fenix Wool</b> , FABRIC <b>Visual</b> , FABRIC <b>Manhattan</b> , FABRIC <b>Novabuk</b> , FABRIC <b>Network</b> , FABRIC <b>Gyre</b> |
| <b>TC</b> | VELVET SUPERB, FABRIC <b>Second</b> , FABRIC <b>Main Line Flax</b> , FABRIC <b>Oceanic</b> , FABRIC <b>Jumper</b> , FABRIC <b>Flame</b> , FABRIC <b>Ouche</b> , FABRIC <b>Plain</b> , FABRIC <b>Gemma</b> , FABRIC <b>Caltagirone 114</b> | <b>TD</b> | FABRIC <b>Yoredale</b> , FABRIC <b>Remix 3</b>   |
| <b>TE</b> | FABRIC <b>Uniform Melange</b>   | <b>SF</b> | LEATHER <b>Fiore</b>   |
| <b>SV</b> | LEATHER <b>Vintage</b>  | <b>CU</b> | HIDE   |
| <b>CT</b> | TUSCAN HIDE   |           |  |

**Optionals:**

|              |                | Value | Options/notes |
|--------------|----------------|-------|---------------|
| <b>ES-1</b>  | Fireproof foam | + 6 € | ES-1          |
| <b>PD-F0</b> | Felt pad feet  | + 6 € | PD-F0         |

**Stack S PP**

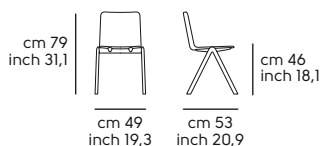

**Stack S PP LG**

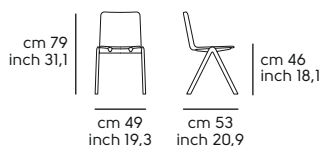

**Stack S PP CU**

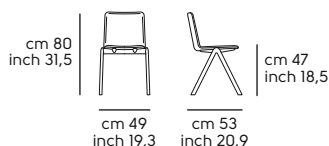

**Stack S PP TS**

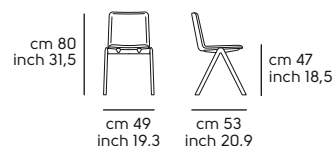

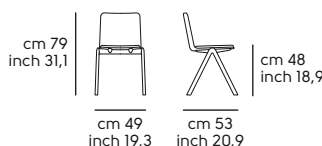

**Stack S PP SD**





# Star design Officina delle Idee

Star S, DSB, DSA, DPB, DPA - Shell in fabric or leather

Frame in: metal



| Model   | Code    | Mod. | Frame | Shell |       |       |       |       |       |       |       | Optional | Q.ty                            | boxes  | Kg     | M <sup>3</sup> |              |
|---|---------|------|-------|-------|-------|-------|-------|-------|-------|-------|-------|----------|---------------------------------|--------|--------|----------------|--------------|
|   |         |      |       | TA    | TB    | TC    | TD    | TE    | SF    | SV    | COM   |          |                                 |        |        |                | COL          |
| <br><br> | S1180SO | S    | MI    | 215 € | 249 € | 284 € | 292 € | 391 € | 370 € | 452 € | 215 € | 284 €    | FM-M2<br>FM-M3<br>ES-1<br>PD-F0 | 2<br>4 | 1<br>1 | 14.5<br>27.0   | 0.35<br>0.53 |

COM/COL - Minimum Q.ty 6 pc. for each material. For weft or patterned fabrics see specific pages

|  |   |
|--|---|
|  Mtl. 0.80 h. 1.40 Each |  Mq. 1.43 Each |
|--|---|



| Model  | Code    | Mod. | Frame | Shell  |         |       |       |       |       |       |       | Optional | Q.ty                            | boxes | Kg    | M <sup>3</sup> |                                 |
|--|---------|------|-------|--|---------|-------|-------|-------|-------|-------|-------|----------|---------------------------------|-------|-------|----------------|---------------------------------|
|  |         |      |       | TA   | TB      | TC    | TD    | TE    | SF    | SV    | COM   |          |                                 |       |       |                | COL                             |
| <br> | S1180DB | DSB  | MI    | 335 €  | 367 €   | 408 € | 413 € | 494 € | 482 € | 553 € | 335 € | 408 €    | FM-M2<br>FM-M3<br>ES-1<br>PD-D1 | 1     | 2     | 11             | 0.20                            |
|  |         |      |       | <br> | S1180EB | DPB   | MI    | 400 € | 434 € | 472 € | 477 € | 560 €    | 545 €                           | 620 € | 400 € | 472 €          | FM-M2<br>FM-M3<br>ES-1<br>PD-D1 |

COM/COL - Minimum Q.ty 6 pc. for each material. For weft or patterned fabrics see specific pages

|  |   |
|--|---|
|  Mtl. 0.80 h. 1.40 Each |  Mq. 1.71 Each |
|--|---|

| Model  | Code    | Mod. | Frame | Shell  |         |       |       |       |       |       |       | Optional | Q.ty                            | boxes | Kg    | M <sup>3</sup> |                                 |
|--|---------|------|-------|--|---------|-------|-------|-------|-------|-------|-------|----------|---------------------------------|-------|-------|----------------|---------------------------------|
|  |         |      |       | TA   | TB      | TC    | TD    | TE    | SF    | SV    | COM   |          |                                 |       |       |                | COL                             |
| <br> | S1180DA | DSA  | MI    | 369 €  | 415 €   | 457 € | 473 € | 547 € | 528 € | 573 € | 369 € | 457 €    | FM-M2<br>FM-M3<br>ES-1<br>PD-D1 | 1     | 2     | 12             | 0.25                            |
|  |         |      |       | <br> | S1180EA | DPA   | MI    | 435 € | 482 € | 522 € | 537 € | 614 €    | 594 €                           | 634 € | 435 € | 522 €          | FM-M2<br>FM-M3<br>ES-1<br>PD-D1 |

COM/COL - Minimum Q.ty 6 pc. for each material. For weft or patterned fabrics see specific pages

|  |   |
|--|---|
|  Mtl. 0.99 h. 1.40 Each |  Mq. 2.54 Each |
|--|---|

**Frame finishes**

|              |   |
|--------------|---|
| <b>Metal</b> |   |
| <b>MI</b>    | WHITE <b>BB</b> , BROWN <b>E6</b> , SAND <b>EC</b> , WHITE PEARL <b>EF</b> , GRAPHITE <b>EG</b> , BLACK <b>EN</b> |

**Shell finishes**

|                   |   |           |  |
|-------------------|---|-----------|--|
| <b>Upholstery</b> |   |           |  |
| <b>TA</b>         | FAUX LEATHER <b>Secret</b> , FABRIC <b>Mirage</b> , FABRIC <b>Cotton Club</b> , FABRIC <b>Renewed Loop</b>  | <b>TB</b> | FAUX LEATHER <b>Vintage</b> , FABRIC <b>Fenix Wool</b> , FABRIC <b>Visual</b> , FABRIC <b>Manhattan</b> , FABRIC <b>Novabuk</b> , FABRIC <b>Network</b> , FABRIC <b>Gyre</b> |
| <b>TC</b>         | VELVET SUPERB, FABRIC <b>Second</b> , FABRIC <b>Main Line Flax</b> , FABRIC <b>Oceanic</b> , FABRIC <b>Jumper</b> , FABRIC <b>Flame</b> , FABRIC <b>Ouche</b> , FABRIC <b>Plain</b> , FABRIC <b>Gemma</b> , FABRIC <b>Caltagirone 114</b> | <b>TD</b> | FABRIC <b>Yoredale</b> , FABRIC <b>Remix 3</b>   |
| <b>TE</b>         | FABRIC <b>Uniform Melange</b>   | <b>SF</b> | LEATHER <b>Fiore</b>   |
| <b>SV</b>         | LEATHER <b>Vintage</b>  |           |  |

**Optionals:**

|              |                          | Value  | Options/notes  |
|--------------|--------------------------|--------|--|
| <b>FM-M2</b> | Indoor matt metal M2     | + 48 € | ASH GREY <b>ES</b> , BLUE SAPPHIRE <b>EE</b> , BLUE TURQUOISE <b>EH</b> , BRONZE <b>E2</b> , BULGARO RED <b>FP</b> , CHERRY RED <b>EQ</b> , DARK GREEN <b>EL</b> , FACEPOWDER PINK <b>E8</b> , FANGO <b>E3</b> , GOLDEN YELLOW <b>EO</b> , LIGHT BLUE <b>EO</b> , LIGHT GREY <b>ET</b> , OCEAN BLUE <b>E1</b> , OCHER YELLOW <b>E7</b> , PAPAYA ORANGE <b>EA</b> , PASTEL YELLOW <b>E4</b> , PINE GREEN <b>EJ</b> , RED <b>ER</b> , SAGE GREEN <b>E9</b> |
| <b>FM-M3</b> | Indoor glossy metal M3   | + 21 € | CHROME <b>CC</b>   |
| <b>ES-1</b>  | Fireproof foam           | + 6 €  | ES-1   |
| <b>PD-F0</b> | Felt pad feet            | + 6 €  | PD-F0  |
| <b>PD-D1</b> | Set Feet Office chair D1 | + 6 €  | PD-D1  |

**Star S**

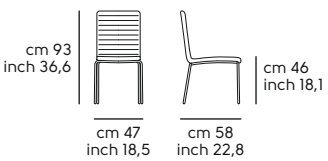

**Star DSB**

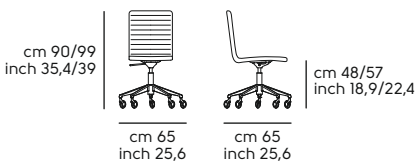

**Star DPB**

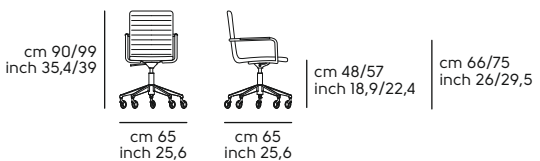

**Star DSA**

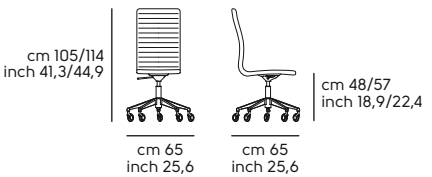

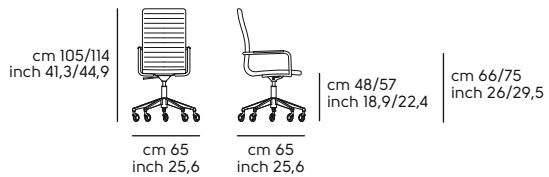

**Star DPA**



# Strike design AtelierNanni

## Strike S, P - Metal Back

Frame in: wood

| Model   | Code    | Mod. | Frame and Seat | Backrest |       | Optional | Q.ty | boxes | Kg  | M <sup>3</sup> |
|---|---------|------|----------------|----------|-------|----------|------|-------|-----|----------------|
|   |         |      |                | M1       | M2    |          |      |       |     |                |
| <b>Chair STRIKE S L</b><br>    | S1740S0 | S    | LF1            | 483 €    | 537 € |          | 2    | 1     | 12  | 0.30           |
| <b>Armchair STRIKE P L</b><br> | S1740P0 | P    | LF1            | 504 €    | 560 € |          | 1    | 1     | 6.5 | 0.30           |

### Seat and Frame finishes

#### Wood

##### LF1

Ash wood stained BLACK **F04**, Ash wood stained WHITE **F05**, Ash wood stained CHERRY RED **F09**, Ash wood stained FLAMED WALNUT **F24**, Ash wood stained DARK BROWN **F26**, Ash wood stained NATURAL **F40**, Ash wood stained NATURAL OAK **F52**, Ash wood stained WHITENED **F60**, Ash wood stained DESERT **F61**, Ash wood stained LIGHT GREY **F62**, Ash wood stained DARK GREY **F63**

### Back finishes

#### Metal

##### M1

WHITE **BB**, BROWN **E6**, SAND **EC**, WHITE PEARL **EF**, GRAPHITE **EG**, BLACK **EN**

##### M2

LIGHT BLUE **E0**, OCEAN BLUE **E1**, BRONZE **E2**, FANGO **E3**, PASTEL YELLOW **E4**, OCHER YELLOW **E7**, FACEPOWDER PINK **E8**, SAGE GREEN **E9**, PAPAYA ORANGE **EA**, BLUE SAPPHIRE **EE**, BLUE TURQUOISE **EH**, PINE GREEN **EJ**, DARK GREEN **EL**, GOLDEN YELLOW **EO**, CHERRY RED **EQ**, RED **ER**, ASH GREY **ES**, LIGHT GREY **ET**, BULGARO RED **FP**

### Strike S

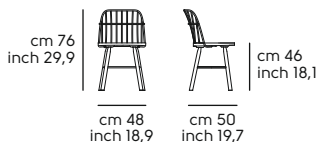

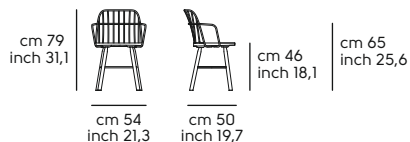

### Strike P



# Suite design AtelierNanni

## Suite P, AP - Seat and back in hide

Frame in: wood

| Model  | Code    | Mod. | Frame | Seat and Backrest |         | Optional | Q.ty | boxes | Kg  | M <sup>3</sup> |
|--|---------|------|-------|-------------------|---------|----------|------|-------|-----|----------------|
|  |         |      |       | CU                | CT      |          |      |       |     |                |
| <b>Armchair SUITE P L CU</b><br>       | S1750PO | P    | LFI   | 674 €             | 903 €   | PD-F0    | 1    | 1     | 9.5 | 0.27           |
| <b>Waiting Chair SUITE AP L CU</b><br> | S1750AC | AP   | LFI   | 977 €             | 1.216 € | PD-F0    | 1    | 1     | 10  | 0.40           |

### Frame finishes

#### Wood

##### LFI

Ash wood stained BLACK **F04**, Ash wood stained WHITE **F05**, Ash wood stained CHERRY RED **F09**, Ash wood stained FLAMED WALNUT **F24**, Ash wood stained DARK BROWN **F26**, Ash wood stained NATURAL **F40**, Ash wood stained NATURAL OAK **F52**, Ash wood stained WHITENED **F60**, Ash wood stained DESERT **F61**, Ash wood stained LIGHT GREY **F62**, Ash wood stained DARK GREY **F63**

### Shell finishes

#### Upholstery

##### CU

HIDE

##### CT

TUSCAN HIDE

### Optionals:

|              | Value | Options/notes |
|--------------|-------|---------------|
| <b>PD-F0</b> | + 6 € | PD-F0         |

### Suite P

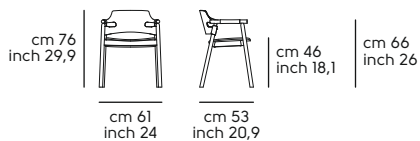

### Suite AP

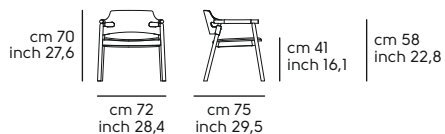

# Tosca design Paolo Vernier

## Tosca S M - Seat and back in hide, fabric or leather, wood

Frame in: metal

| Model  | Code    | Mod. | Frame | Seat and Backrest |  |  |  |       |  |  |  | Optional               | Q.ty | boxes | Kg | M <sup>3</sup> |
|--|---------|------|-------|-------------------|--|--|--|-------|--|--|--|------------------------|------|-------|----|----------------|
|  |         |      |       | CU                |  |  |  | CT    |  |  |  |                        |      |       |    |                |
|  Chair TOSCA S M CU | S2350SC | S    | MI    | 399 €             |  |  |  | 469 € |  |  |  | FM-M2<br>ES-1<br>PD-FO | 2    | 1     | 14 | 0.26           |

| Model  | Code    | Mod. | Frame | TA    | TB    | TC    | TD    | TE    | SF    | SV    | COM   | COL   | Optional               | Q.ty | boxes | Kg | M <sup>3</sup> |
|--|---------|------|-------|-------|-------|-------|-------|-------|-------|-------|-------|-------|------------------------|------|-------|----|----------------|
|  |         |      |       |       |       |       |       |       |       |       |       |       |                        |      |       |    |                |
|  Chair TOSCA S M TS | S2350ST | S    | MI    | 309 € | 338 € | 372 € | 403 € | 496 € | 399 € | 439 € | 309 € | 372 € | FM-M2<br>ES-1<br>PD-FO | 2    | 1     | 14 | 0.26           |

COM/COL - Minimum Q.ty 6 pc. for each material. For weft or patterned fabrics see specific pages

|   |                        |   |               |
|---|------------------------|---|---------------|
|  COM | Mtl. 0.70 h. 1.40 Each |  COL | Mq. 0.90 Each |
|---|------------------------|---|---------------|

| Model  | Code    | Mod. | Frame | Seat and Back (Backrest LI1) |       |       |       |       |       |       |       | Optional | Q.ty                            | boxes | Kg | M <sup>3</sup> |      |
|--|---------|------|-------|------------------------------|-------|-------|-------|-------|-------|-------|-------|----------|---------------------------------|-------|----|----------------|------|
|  |         |      |       | TA                           | TB    | TC    | TD    | TE    | SF    | SV    | COM   |          |                                 |       |    |                | COL  |
|  Chair TOSCA S M TS/L | S2350SS | S    | MI    | 346 €                        | 368 € | 402 € | 425 € | 514 € | 425 € | 459 € | 346 € | 402 €    | FM-M2<br>FL-I2<br>ES-1<br>PD-FO | 2     | 1  | 14             | 0.26 |

COM/COL - Minimum Q.ty 6 pc. for each material. For weft or patterned fabrics see specific pages

|   |                        |   |               |
|---|------------------------|---|---------------|
|  COM | Mtl. 0.70 h. 1.40 Each |  COL | Mq. 0.70 Each |
|---|------------------------|---|---------------|

| Model  | Code    | Mod. | Frame | Seat and Backrest |  |  |  |       |  |  |  | Optional       | Q.ty | boxes | Kg | M <sup>3</sup> |
|--|---------|------|-------|-------------------|--|--|--|-------|--|--|--|----------------|------|-------|----|----------------|
|  |         |      |       | LI1               |  |  |  | LI2   |  |  |  |                |      |       |    |                |
|  Chair TOSCA S M LG | S2350SO | S    | MI    | 317 €             |  |  |  | 343 € |  |  |  | FM-M2<br>PD-FO | 2    | 1     | 14 | 0.26           |

**Frame finishes**

**Metal**

|           |   |
|-----------|---|
| <b>MI</b> | WHITE <b>BB</b> , BROWN <b>E6</b> , SAND <b>EC</b> , WHITE PEARL <b>EF</b> , GRAPHITE <b>EG</b> , BLACK <b>EN</b> |
|-----------|---|

**Backrest back finishes**

**Wood**

|            |  |
|------------|--|
| <b>LII</b> | Veneered wood painted BLACK <b>I04</b> , Veneered wood painted WHITE <b>I05</b> , Veneered wood painted CHERRY RED <b>I09</b> , Veneered wood painted DARK BROWN <b>I26</b> , Veneered wood painted NATURAL <b>I40</b> , Veneered wood painted NATURAL OAK <b>I52</b> , Veneered wood painted WHITENED <b>I60</b> , Veneered wood painted DESERT <b>I61</b> , Veneered wood painted LIGHT GREY <b>I62</b> , Veneered wood painted DARK GREY <b>I63</b> |
|------------|--|

**Seat and Back finishes**

**Wood**

|             |  |
|-------------|--|
| <b>LII</b>  | Veneered wood painted BLACK <b>I04</b> , Veneered wood painted WHITE <b>I05</b> , Veneered wood painted CHERRY RED <b>I09</b> , Veneered wood painted DARK BROWN <b>I26</b> , Veneered wood painted NATURAL <b>I40</b> , Veneered wood painted NATURAL OAK <b>I52</b> , Veneered wood painted WHITENED <b>I60</b> , Veneered wood painted DESERT <b>I61</b> , Veneered wood painted LIGHT GREY <b>I62</b> , Veneered wood painted DARK GREY <b>I63</b> |
| <b>LII2</b> | Veneered wood NATURAL OAK <b>I22</b> , Veneered wood FLAMED WALNUT <b>I24</b>  |

**Upholstery**

|           |   |           |  |
|-----------|---|-----------|--|
| <b>TA</b> | FAUX LEATHER <b>Secret</b> , FABRIC <b>Mirage</b> , FABRIC <b>Cotton Club</b> , FABRIC <b>Renewed Loop</b>  | <b>TB</b> | FAUX LEATHER <b>Vintage</b> , FABRIC <b>Fenix Wool</b> , FABRIC <b>Visual</b> , FABRIC <b>Manhattan</b> , FABRIC <b>Novabuk</b> , FABRIC <b>Network</b> , FABRIC <b>Gyre</b> |
| <b>TC</b> | VELVET SUPERB, FABRIC <b>Second</b> , FABRIC <b>Main Line Flax</b> , FABRIC <b>Oceanic</b> , FABRIC <b>Jumper</b> , FABRIC <b>Flame</b> , FABRIC <b>Ouche</b> , FABRIC <b>Plain</b> , FABRIC <b>Gemma</b> , FABRIC <b>Caltagirone 114</b> | <b>TD</b> | FABRIC <b>Yoredale</b> , FABRIC <b>Remix 3</b>   |
| <b>TE</b> | FABRIC <b>Uniform Melange</b>   | <b>SF</b> | LEATHER <b>Fiore</b>   |
| <b>SV</b> | LEATHER <b>Vintage</b>  | <b>CU</b> | HIDE   |
| <b>CT</b> | TUSCAN HIDE   |           |  |

**Optionals:**

|              |                          | Value  | Options/notes  |
|--------------|--------------------------|--------|--|
| <b>FM-M2</b> | Indoor matt metal M2     | + 47 € | ASH GREY <b>ES</b> , BLUE SAPPHIRE <b>EE</b> , BLUE TURQUOISE <b>EH</b> , BRONZE <b>E2</b> , BULGARO RED <b>FP</b> , CHERRY RED <b>EQ</b> , DARK GREEN <b>EL</b> , FACEPOWDER PINK <b>E8</b> , FANGO <b>E3</b> , GOLDEN YELLOW <b>EO</b> , LIGHT BLUE <b>EO</b> , LIGHT GREY <b>ET</b> , OCEAN BLUE <b>EI</b> , OCHER YELLOW <b>E7</b> , PAPAYA ORANGE <b>EA</b> , PASTEL YELLOW <b>E4</b> , PINE GREEN <b>EJ</b> , RED <b>ER</b> , SAGE GREEN <b>E9</b> |
| <b>FL-I2</b> | Veneered wood finish LI2 | + 20 € | Veneered wood FLAMED WALNUT <b>I24</b> , Veneered wood NATURAL OAK <b>I22</b>  |
| <b>ES-1</b>  | Fireproof foam           | + 5 €  | ES-1   |
| <b>PD-F0</b> | Felt pad feet            | + 6 €  | PD-F0  |

**Tosca S TS-CU**

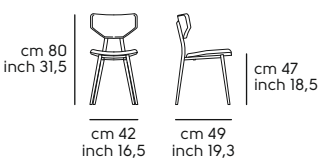

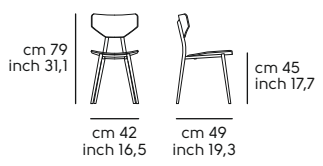

**Tosca S LG**





**Tosca H65-75 - Seat and back in hide, fabric or leather, wood**



Frame in: metal

| Model  | Code    | Mod. | Frame | Seat and Backrest |  |  |  |       |  |  |  | Optional               | Q.ty | boxes | Kg  | M <sup>3</sup> |
|--|---------|------|-------|-------------------|--|--|--|-------|--|--|--|------------------------|------|-------|-----|----------------|
|  |         |      |       | CU                |  |  |  | CT    |  |  |  |                        |      |       |     |                |
| <br><b>Stool TOSCA H65 M CU</b> | S2350HC | H65  | M1    | 470 €             |  |  |  | 541 € |  |  |  | FM-M2<br>ES-1<br>PD-F0 | 1    | 1     | 9   | 0.21           |
| <br><b>Stool TOSCA H75 M CU</b> | S2350JC | H75  | M1    | 481 €             |  |  |  | 553 € |  |  |  | FM-M2<br>ES-1<br>PD-F0 | 1    | 1     | 9.5 | 0.25           |

| Model   | Code    | Mod. | Frame | TA    | TB    | TC    | TD    | TE    | SF    | SV    | COM   | COL   | Optional               | Q.ty | boxes | Kg  | M <sup>3</sup> |
|---|---------|------|-------|-------|-------|-------|-------|-------|-------|-------|-------|-------|------------------------|------|-------|-----|----------------|
| <br><b>Stool TOSCA H65 M TS</b>  | S2350HT | H65  | M1    | 394 € | 421 € | 458 € | 478 € | 552 € | 480 € | 522 € | 394 € | 458 € | FM-M2<br>ES-1<br>PD-F0 | 1    | 1     | 9   | 0.21           |
| <br><b>Stool TOSCA H75 M TS</b> | S2350JT | H75  | M1    | 404 € | 431 € | 468 € | 489 € | 562 € | 491 € | 532 € | 404 € | 468 € | FM-M2<br>ES-1<br>PD-F0 | 1    | 1     | 9.5 | 0.25           |



**COM/COL - Minimum Q.ty 6 pc. for each material. For weft or patterned fabrics see specific pages**

|  |   |
|--|---|
|  Mtl. 0.70 h. 1.40 Each |  Mq. 0.85 Each |
|--|---|

| Model  | Code    | Mod. | Frame | Seat and Back (Backrest LII) |       |       |       |       |       |       |       | Optional | Q.ty                            | boxes | Kg | M <sup>3</sup> |      |
|--|---------|------|-------|------------------------------|-------|-------|-------|-------|-------|-------|-------|----------|---------------------------------|-------|----|----------------|------|
|  |         |      |       | TA                           | TB    | TC    | TD    | TE    | SF    | SV    | COM   | COL      |                                 |       |    |                |      |
| <br><b>Stool TOSCA H65 M TS/L</b> | S2350HS | H65  | M1    | 435 €                        | 460 € | 497 € | 517 € | 565 € | 525 € | 545 € | 435 € | 497 €    | FM-M2<br>FL-I2<br>ES-1<br>PD-F0 | 1     | 1  | 9              | 0.21 |
| <br><b>Stool TOSCA H75 M TS/L</b> | S2350JS | H75  | M1    | 445 €                        | 470 € | 507 € | 527 € | 575 € | 536 € | 555 € | 445 € | 507 €    | FM-M2<br>FL-I2<br>ES-1<br>PD-F0 | 1     | 1  | 9.5            | 0.25 |

**COM/COL - Minimum Q.ty 6 pc. for each material. For weft or patterned fabrics see specific pages**

|  |   |
|--|---|
|  Mtl. 0.70 h. 1.40 Each |  Mq. 0.65 Each |
|--|---|

| Model  | Code    | Mod. | Frame | Seat and Backrest |       | Optional       | Q.ty | boxes | Kg  | M <sup>3</sup> |
|--|---------|------|-------|-------------------|-------|----------------|------|-------|-----|----------------|
|  |         |      |       | L11               | L12   |                |      |       |     |                |
|  <b>Stool TOSCA H65 M LG</b> | S2350H0 | H65  | M1    | 385 €             | 408 € | FM-M2<br>PD-FO | 1    | 1     | 9   | 0.21           |
|  <b>Stool TOSCA H75 M LG</b> | S2350J0 | H75  | M1    | 395 €             | 418 € | FM-M2<br>PD-FO | 1    | 1     | 9.5 | 0.25           |

#### Frame finishes

##### Metal

**MI** WHITE **BB**, BROWN **E6**, SAND **EC**, WHITE PEARL **EF**, GRAPHITE **EG**, BLACK **EN**

#### Backrest back finishes

##### Wood

**L11**

Veneered wood painted BLACK **I04**, Veneered wood painted WHITE **I05**, Veneered wood painted CHERRY RED **I09**, Veneered wood painted DARK BROWN **I26**, Veneered wood painted NATURAL **I40**, Veneered wood painted NATURAL OAK **I52**, Veneered wood painted WHITENED **I60**, Veneered wood painted DESERT **I61**, Veneered wood painted LIGHT GREY **I62**, Veneered wood painted DARK GREY **I63**

#### Seat and Back finishes

##### Wood

**L11**

Veneered wood painted BLACK **I04**, Veneered wood painted WHITE **I05**, Veneered wood painted CHERRY RED **I09**, Veneered wood painted DARK BROWN **I26**, Veneered wood painted NATURAL **I40**, Veneered wood painted NATURAL OAK **I52**, Veneered wood painted WHITENED **I60**, Veneered wood painted DESERT **I61**, Veneered wood painted LIGHT GREY **I62**, Veneered wood painted DARK GREY **I63**

**L12**

Veneered wood NATURAL OAK **I22**, Veneered wood FLAMED WALNUT **I24**

#### Upholstery

|           |   |
|-----------|---|
| <b>TA</b> | FAUX LEATHER <b>Secret</b> , FABRIC <b>Mirage</b> , FABRIC <b>Cotton Club</b> , FABRIC <b>Renewed Loop</b>  |
| <b>TC</b> | VELVET SUPERB, FABRIC <b>Second</b> , FABRIC <b>Main Line Flax</b> , FABRIC <b>Oceanic</b> , FABRIC <b>Jumper</b> , FABRIC <b>Flame</b> , FABRIC <b>Ouche</b> , FABRIC <b>Plain</b> , FABRIC <b>Gemma</b> , FABRIC <b>Caltagirone 114</b> |
| <b>TE</b> | FABRIC <b>Uniform Melange</b>   |
| <b>SV</b> | LEATHER <b>Vintage</b>  |
| <b>CT</b> | TUSCAN HIDE   |

|           |  |
|-----------|--|
| <b>TB</b> | FAUX LEATHER <b>Vintage</b> , FABRIC <b>Fenix Wool</b> , FABRIC <b>Visual</b> , FABRIC <b>Manhattan</b> , FABRIC <b>Novabuk</b> , FABRIC <b>Network</b> , FABRIC <b>Gyre</b> |
| <b>TD</b> | FABRIC <b>Yoredale</b> , FABRIC <b>Remix 3</b>   |
| <b>SF</b> | LEATHER <b>Fiore</b>   |
| <b>CU</b> | HIDE   |

#### Optionals:

|              |                          | Value  | Options/notes  |
|--------------|--------------------------|--------|--|
| <b>FM-M2</b> | Indoor matt metal M2     | + 47 € | ASH GREY <b>ES</b> , BLUE SAPPHIRE <b>EE</b> , BLUE TURQUOISE <b>EH</b> , BRONZE <b>E2</b> , BULGARO RED <b>FP</b> , CHERRY RED <b>EQ</b> , DARK GREEN <b>EL</b> , FACEPOWDER PINK <b>E8</b> , FANGO <b>E3</b> , GOLDEN YELLOW <b>EO</b> , LIGHT BLUE <b>EO</b> , LIGHT GREY <b>ET</b> , OCEAN BLUE <b>E1</b> , OCHER YELLOW <b>E7</b> , PAPAYA ORANGE <b>EA</b> , PASTEL YELLOW <b>E4</b> , PINE GREEN <b>EJ</b> , RED <b>ER</b> , SAGE GREEN <b>E9</b> |
| <b>FL-I2</b> | Veneered wood finish L12 | + 20 € | Veneered wood FLAMED WALNUT <b>I24</b> , Veneered wood NATURAL OAK <b>I22</b>  |
| <b>ES-1</b>  | Fireproof foam           | + 5 €  | ES-1   |
| <b>PD-F0</b> | Felt pad feet            | + 6 €  | PD-F0  |

#### Tosca H65 TS-CU

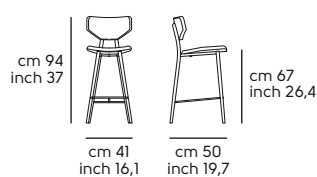

#### Tosca H75 TS-CU

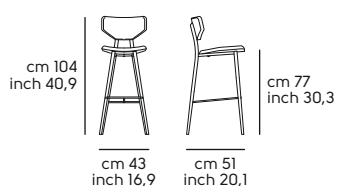

#### Tosca H65 LG

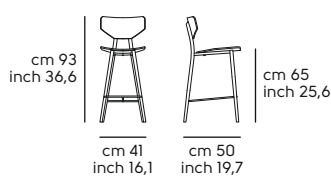

#### Tosca H75 LG

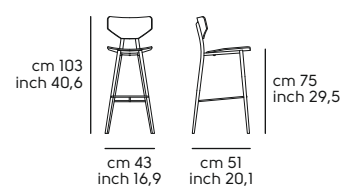

# Toy design Studio Pastina

## Toy SG - Seat and back in fabric or leather

Frame in: metal

| Model   | Code    | Mod. | Frame | Seat and Backrest |       |       |       |       |       |       |       | Optional | G.ty  | boxes | Kg | M³ |      |
|---|---------|------|-------|-------------------|-------|-------|-------|-------|-------|-------|-------|----------|-------|-------|----|----|------|
|   |         |      |       | TA                | TB    | TC    | TD    | TE    | SF    | SV    | COM   |          |       |       |    |    | COL  |
| <br><b>Stool TOY SG TS</b> | S2130ZT | SG   | MI    | 568 €             | 581 € | 610 € | 639 € | 734 € | 643 € | 665 € | 568 € | 610 €    | FM-M2 | 1     | 1  | 17 | 0.20 |

Note:

### Frame finishes

#### Metal

**MI** WHITE **BB**, BROWN **E6**, SAND **EC**, WHITE PEARL **EF**, GRAPHITE **EG**, BLACK **EN**

### Seat and Back finishes

#### Upholstery

|           |   |           |  |
|-----------|---|-----------|--|
| <b>TA</b> | FAUX LEATHER <b>Secret</b> , FABRIC <b>Mirage</b> , FABRIC <b>Cotton Club</b> , FABRIC <b>Renewed Loop</b>  | <b>TB</b> | FAUX LEATHER <b>Vintage</b> , FABRIC <b>Fenix Wool</b> , FABRIC <b>Visual</b> , FABRIC <b>Manhattan</b> , FABRIC <b>Novabuk</b> , FABRIC <b>Network</b> , FABRIC <b>Gyre</b> |
| <b>TC</b> | VELVET SUPERB, FABRIC <b>Second</b> , FABRIC <b>Main Line Flax</b> , FABRIC <b>Oceanic</b> , FABRIC <b>Jumper</b> , FABRIC <b>Flame</b> , FABRIC <b>Ouche</b> , FABRIC <b>Plain</b> , FABRIC <b>Gemma</b> , FABRIC <b>Caltagirone II4</b> | <b>TD</b> | FABRIC <b>Yoredale</b> , FABRIC <b>Remix 3</b>   |
| <b>TE</b> | FABRIC <b>Uniform Melange</b>   | <b>SF</b> | LEATHER <b>Fiore</b>   |
| <b>SV</b> | LEATHER <b>Vintage</b>  |           |  |

**COM/COL - Minimum Q.ty 6 pc. for each material. For weft or patterned fabrics see specific pages**

|            |                        |            |               |
|------------|------------------------|------------|---------------|
| <b>COM</b> | Mtl. 0.72 h. 1.40 Each | <b>COL</b> | Mq. 1.31 Each |
|------------|------------------------|------------|---------------|

### Optionals:

|              | Value  | Options/notes  |
|--------------|--------|--|
| <b>FM-M2</b> | + 58 € | ASH GREY <b>ES</b> , BLUE SAPPHIRE <b>EE</b> , BLUE TURQUOISE <b>EH</b> , BRONZE <b>E2</b> , BULGARO RED <b>FP</b> , CHERRY RED <b>EQ</b> , DARK GREEN <b>EL</b> , FACEPOWDER PINK <b>E8</b> , FANGO <b>E3</b> , GOLDEN YELLOW <b>EO</b> , LIGHT BLUE <b>ED</b> , LIGHT GREY <b>ET</b> , OCEAN BLUE <b>E1</b> , OCHER YELLOW <b>E7</b> , PAPAYA ORANGE <b>EA</b> , PASTEL YELLOW <b>E4</b> , PINE GREEN <b>EJ</b> , RED <b>ER</b> , SAGE GREEN <b>E9</b> |

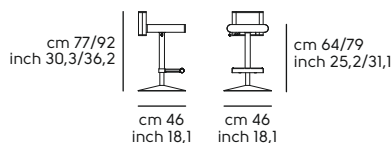

### Toy SG



# Trampoliere design Roberto Paoli

## Trampoliere OUT S, P, H65-75 - Metal Shell

Frame in: metal

| Model   | Code    | Mod. | -- | Frame |       | Optional | G.ty   | boxes  | Kg          | M <sup>3</sup> |
|---|---------|------|----|-------|-------|----------|--------|--------|-------------|----------------|
|   |         |      |    | O1    | O2    |          |        |        |             |                |
| <b>Chair TRAMPOLIERE OUT S M</b><br>    | S1550M2 | S    |    | 220 € | 292 € |          | 4      | 1      | 26          | 0.32           |
| <b>Stool TRAMPOLIERE OUT H65 M</b><br>  | S1550I2 | H65  |    | 252 € | 326 € |          | 1<br>2 | 1<br>1 | 8.1<br>16.2 | 0.20<br>0.25   |
| <b>Stool TRAMPOLIERE OUT H75 M</b><br> | S1550K2 | H75  |    | 252 € | 326 € |          | 1<br>2 | 1<br>1 | 8.1<br>16.2 | 0.20<br>0.25   |

### Frame finishes

#### Metal Outdoor

|           |  |
|-----------|--|
| <b>O1</b> | Outdoor BROWN <b>E6</b> , Outdoor WHITE <b>BB</b> , Outdoor SAND <b>EC</b> , Outdoor WHITE PEARL <b>EF</b> , Outdoor GRAFITE <b>EG</b> , Outdoor BLACK <b>EN</b>   |
| <b>O2</b> | Outdoor LIGHT BLUE <b>E0</b> , Outdoor OCEAN BLUE <b>E1</b> , Outdoor BRONZE <b>E2</b> , Outdoor FANGO <b>E3</b> , Outdoor PASTEL YELLOW <b>E4</b> , Outdoor OCHER YELLOW <b>E7</b> , Outdoor FACEPOWDER PINK <b>E8</b> , Outdoor SAGE GREEN <b>E9</b> , Outdoor BLUE SAPPHIRE <b>EE</b> , Outdoor BLUE TURQUOISE <b>EH</b> , Outdoor PINE GREEN <b>EJ</b> , Outdoor DARK GREEN <b>EL</b> , Outdoor GOLD YELLOW <b>EO</b> , Outdoor RED BULGARO <b>FP</b> , Outdoor CHERRY RED <b>EQ</b> , Outdoor RED <b>ER</b> , Outdoor ASH GREY <b>ES</b> , Outdoor LIGHT GREY <b>ET</b> , Outdoor PAPAYA ORANGE <b>EA</b> |

#### Trampoliere S

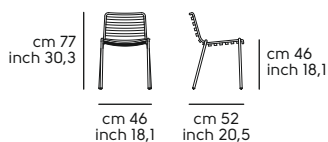

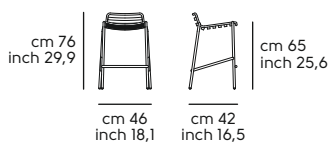

#### Trampoliere H65

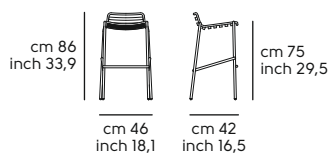

#### Trampoliere H75



**Trampoline Cushion - Fabric or Leather**

| Model   | Code    | Mod.    | -- | Upholstery |       |       |       |       |       |       |      |       | Optional | Q.ty | boxes | Kg  | M²   |
|---|---------|---------|----|------------|-------|-------|-------|-------|-------|-------|------|-------|----------|------|-------|-----|------|
|   |         |         |    | TA         | TB    | TC    | TD    | TE    | SF    | SV    | COM  | COL   |          |      |       |     |      |
| <b>Cushion TRAMPOLIERE S</b><br>       | A1550C0 | S       |    | 95 €       | 106 € | 122 € | 133 € | 174 € | 151 € | 183 € | 95 € | 122 € | ES-1     | 4    | 1     | 1.2 | 0.04 |
| <b>Cushion TRAMPOLIERE H65-H75</b><br> | A1550C1 | H65-H75 |    | 90 €       | 99 €  | 113 € | 124 € | 160 € | 142 € | 172 € | 90 € | 113 € | ES-1     | 4    | 1     | 1   | 0.01 |

**COM/COL - Minimum Q.ty 6 pc. for each material. For weft or patterned fabrics see specific pages**

|  |   |
|--|---|
|  Mtl. 0.40 h. 1.40 Each |  Mq. 0.60 Each |
|--|---|

**Cushion finishes**

**Upholstery**

|           |   |           |  |
|-----------|---|-----------|--|
| <b>TA</b> | FAUX LEATHER <b>Secret</b> , FABRIC <b>Mirage</b> , FABRIC <b>Cotton Club</b> , FABRIC <b>Renewed Loop</b>  | <b>TB</b> | FAUX LEATHER <b>Vintage</b> , FABRIC <b>Fenix Wool</b> , FABRIC <b>Visual</b> , FABRIC <b>Manhattan</b> , FABRIC <b>Novabuk</b> , FABRIC <b>Network</b> , FABRIC <b>Gyre</b> |
| <b>TC</b> | VELVET SUPERB, FABRIC <b>Second</b> , FABRIC <b>Main Line Flax</b> , FABRIC <b>Oceanic</b> , FABRIC <b>Jumper</b> , FABRIC <b>Flame</b> , FABRIC <b>Ouche</b> , FABRIC <b>Plain</b> , FABRIC <b>Gemma</b> , FABRIC <b>Caltagirone 114</b> | <b>TD</b> | FABRIC <b>Yoredale</b> , FABRIC <b>Remix 3</b>   |
| <b>TE</b> | FABRIC <b>Uniform Melange</b>   | <b>SF</b> | LEATHER <b>Fiore</b>   |
| <b>SV</b> | LEATHER <b>Vintage</b>  |           |  |

**Optionals:**

|             | Value          | Options/notes |
|-------------|----------------|---------------|
| <b>ES-1</b> | Fireproof foam | + 6 € ES-1    |

# Wrap design Balutto Associati

## Wrap S, P - Shell in fabric or leather

Frame in: metal or wood

| Model  | Code    | Base type | Frame | Shell |       |       |       |       |       |       |       |       | Optional               | Q.ty | boxes | Kg   | M <sup>3</sup> |
|--|---------|-----------|-------|-------|-------|-------|-------|-------|-------|-------|-------|-------|------------------------|------|-------|------|----------------|
|  |         |           |       | TA    | TB    | TC    | TD    | TE    | SF    | SV    | COM   | COL   |                        |      |       |      |                |
|  Chair WRAP S M TS | S1590S0 | _M        | MI    | 299 € | 342 € | 388 € | 399 € | 483 € | 467 € | 562 € | 299 € | 388 € | FM-M2<br>ES-1<br>PD-F0 | 2    | 1     | 13.5 | 0.41           |

COM/COL - Minimum Q.ty 6 pc. for each material. For weft or patterned fabrics see specific pages

|   |   |
|---|---|
|  Mtl. 0.90 h. 1.40 Each |  Mq. 2.15 Each |
|---|---|

| Model  | Code    | Base type | Frame | Shell |       |       |       |       |       |       |       |       | Optional               | Q.ty | boxes | Kg   | M <sup>3</sup> |
|--|---------|-----------|-------|-------|-------|-------|-------|-------|-------|-------|-------|-------|------------------------|------|-------|------|----------------|
|  |         |           |       | TA    | TB    | TC    | TD    | TE    | SF    | SV    | COM   | COL   |                        |      |       |      |                |
|  Armchair WRAP P M TS | S1590P0 | _M        | MI    | 378 € | 416 € | 473 € | 491 € | 614 € | 534 € | 668 € | 378 € | 473 € | FM-M2<br>ES-1<br>PD-F0 | 2    | 1     | 16.8 | 0.48           |

COM/COL - Minimum Q.ty 6 pc. for each material. For weft or patterned fabrics see specific pages

|   |   |
|---|---|
|  Mtl. 1.20 h. 1.40 Each |  Mq. 2.34 Each |
|---|---|

**Note:**

TS Front and Back covering available in two-tone or bi-material. Reference price in the upper category

**Frame finishes**

**Metal**

|           |   |
|-----------|---|
| <b>MI</b> | WHITE <b>BB</b> , BROWN <b>E6</b> , SAND <b>EC</b> , WHITE PEARL <b>EF</b> , GRAPHITE <b>EG</b> , BLACK <b>EN</b> |
|-----------|---|

**Shell finishes**

**Upholstery**

|           |   |           |  |
|-----------|---|-----------|--|
| <b>TA</b> | FAUX LEATHER <b>Secret</b> , FABRIC <b>Mirage</b> , FABRIC <b>Cotton Club</b> , FABRIC <b>Renewed Loop</b>  | <b>TB</b> | FAUX LEATHER <b>Vintage</b> , FABRIC <b>Fenix Wool</b> , FABRIC <b>Visual</b> , FABRIC <b>Manhattan</b> , FABRIC <b>Novabuk</b> , FABRIC <b>Network</b> , FABRIC <b>Gyre</b> |
| <b>TC</b> | VELVET SUPERB, FABRIC <b>Second</b> , FABRIC <b>Main Line Flax</b> , FABRIC <b>Oceanic</b> , FABRIC <b>Jumper</b> , FABRIC <b>Flame</b> , FABRIC <b>Ouche</b> , FABRIC <b>Plain</b> , FABRIC <b>Gemma</b> , FABRIC <b>Caltagirone 114</b> | <b>TD</b> | FABRIC <b>Yoredale</b> , FABRIC <b>Remix 3</b>   |
| <b>TE</b> | FABRIC <b>Uniform Melange</b>   | <b>SF</b> | LEATHER <b>Fiore</b>   |
| <b>SV</b> | LEATHER <b>Vintage</b>  |           |  |

**Optionals:**

|              |                      | Value  | Options/notes  |
|--------------|----------------------|--------|--|
| <b>FM-M2</b> | Indoor matt metal M2 | + 48 € | ASH GREY <b>ES</b> , BLUE SAPPHIRE <b>EE</b> , BLUE TURQUOISE <b>EH</b> , BRONZE <b>E2</b> , BULGARO RED <b>FP</b> , CHERRY RED <b>EQ</b> , DARK GREEN <b>EL</b> , FACEPOWDER PINK <b>E8</b> , FANGO <b>E3</b> , GOLDEN YELLOW <b>EO</b> , LIGHT BLUE <b>EO</b> , LIGHT GREY <b>ET</b> , OCEAN BLUE <b>E1</b> , OCHER YELLOW <b>E7</b> , PAPAYA ORANGE <b>EA</b> , PASTEL YELLOW <b>E4</b> , PINE GREEN <b>EJ</b> , RED <b>ER</b> , SAGE GREEN <b>E9</b> |
| <b>ES-1</b>  | Fireproof foam       | + 6 €  | ES-1   |
| <b>PD-F0</b> | Felt pad feet        | + 6 €  | PD-F0  |

**Wrap S\_M**

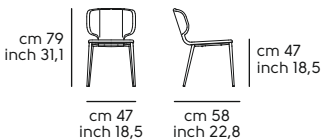

**Wrap P\_M**

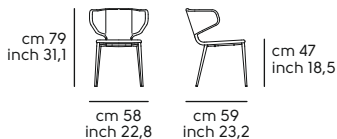

## Wrap H65-75 - Shell in fabric or leather

Frame in: metal

| Model  | Code    | Mod. | Frame | Shell |       |       |       |       |       |       |       |       | Optional               | Q.ty<br> | boxes<br> | Kg<br> | M³<br> |
|--|---------|------|-------|-------|-------|-------|-------|-------|-------|-------|-------|-------|------------------------|----------|-----------|--------|--------|
|  |         |      |       | TA    | TB    | TC    | TD    | TE    | SF    | SV    | COM   | COL   |                        |          |           |        |        |
| <br><b>Stool WRAP H65 M TS</b> | S1590H1 | H65  | MI    | 363 € | 400 € | 438 € | 456 € | 530 € | 511 € | 606 € | 363 € | 438 € | FM-M2<br>ES-1<br>PD-F0 | 1        | 1         | 8.4    | 0.29   |
| <br><b>Stool WRAP H75 M TS</b> | S1590J1 | H75  | MI    | 375 € | 415 € | 452 € | 469 € | 545 € | 524 € | 620 € | 375 € | 452 € | FM-M2<br>ES-1<br>PD-F0 | 1        | 1         | 8.4    | 0.32   |

**Note:**

TS Front and Back covering available in two-tone or bi-material. Reference price in the upper category

### Frame finishes

**Metal**



**MI** WHITE **BB**, BROWN **E6**, SAND **EC**, WHITE PEARL **EF**, GRAPHITE **EG**, BLACK **EN**

### Shell finishes

**Upholstery**

|           |   |           |  |
|-----------|---|-----------|--|
| <b>TA</b> | FAUX LEATHER <b>Secret</b> , FABRIC <b>Mirage</b> , FABRIC <b>Cotton Club</b> , FABRIC <b>Renewed Loop</b>  | <b>TB</b> | FAUX LEATHER <b>Vintage</b> , FABRIC <b>Fenix Wool</b> , FABRIC <b>Visual</b> , FABRIC <b>Manhattan</b> , FABRIC <b>Novabuk</b> , FABRIC <b>Network</b> , FABRIC <b>Gyre</b> |
| <b>TC</b> | VELVET SUPERB, FABRIC <b>Second</b> , FABRIC <b>Main Line Flax</b> , FABRIC <b>Oceanic</b> , FABRIC <b>Jumper</b> , FABRIC <b>Flame</b> , FABRIC <b>Ouche</b> , FABRIC <b>Plain</b> , FABRIC <b>Gemma</b> , FABRIC <b>Caltagirone 114</b> | <b>TD</b> | FABRIC <b>Yoredale</b> , FABRIC <b>Remix 3</b>   |
| <b>TE</b> | FABRIC <b>Uniform Melange</b>   | <b>SF</b> | LEATHER <b>Fiore</b>   |
| <b>SV</b> | LEATHER <b>Vintage</b>  |           |  |

**COM/COL - Minimum Q.ty 6 pc. for each material. For weft or patterned fabrics see specific pages**

|   |                        |  |               |
|---|------------------------|--|---------------|
|  <b>COM</b> | Mtl. 0.85 h. 1.40 Each |  <b>COL</b> | Mq. 1.76 Each |
|---|------------------------|--|---------------|

### Optionals:

|              | Value  | Options/notes  |
|--------------|--------|--|
| <b>FM-M2</b> | + 48 € | ASH GREY <b>ES</b> , BLUE SAPPHIRE <b>EE</b> , BLUE TURQUOISE <b>EH</b> , BRONZE <b>E2</b> , BULGARO RED <b>FP</b> , CHERRY RED <b>EQ</b> , DARK GREEN <b>EL</b> , FACEPOWDER PINK <b>E8</b> , FANGO <b>E3</b> , GOLDEN YELLOW <b>EO</b> , LIGHT BLUE <b>EO</b> , LIGHT GREY <b>ET</b> , OCEAN BLUE <b>E1</b> , OCHER YELLOW <b>E7</b> , PAPAYA ORANGE <b>EA</b> , PASTEL YELLOW <b>E4</b> , PINE GREEN <b>EJ</b> , RED <b>ER</b> , SAGE GREEN <b>E9</b> |
| <b>ES-1</b>  | + 6 €  | ES-1   |
| <b>PD-F0</b> | + 6 €  | PD-F0  |

### Wrap H65

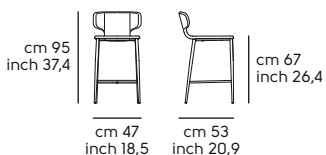

### Wrap H75

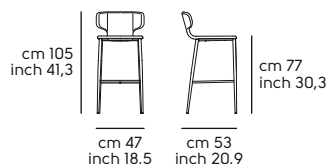

## Wrap SG - Shell in fabric or leather

Frame in: metal

| Model  | Code    | Mod. | Frame | Shell |       |       |       |       |       |       |       |       | Optional      | Q.ty | boxes | Kg | M²   |
|--|---------|------|-------|-------|-------|-------|-------|-------|-------|-------|-------|-------|---------------|------|-------|----|------|
|  |         |      |       | TA    | TB    | TC    | TD    | TE    | SF    | SV    | COM   | COL   |               |      |       |    |      |
| <br><b>Stool WRAP SG TS</b> | S1590ZT | SG   | MI    | 641 € | 678 € | 716 € | 733 € | 808 € | 788 € | 884 € | 641 € | 716 € | FM-M2<br>ES-1 | 1    | 1     | 17 | 0.26 |

**Note:**

TS Front and Back covering available in two-tone or bi-material. Reference price in the upper category

### Frame finishes

**Metal**

**MI** WHITE **BB**, BROWN **E6**, SAND **EC**, WHITE PEARL **EF**, GRAPHITE **EG**, BLACK **EN**

### Shell finishes

**Upholstery**

|           |   |           |  |
|-----------|---|-----------|--|
| <b>TA</b> | FAUX LEATHER <b>Secret</b> , FABRIC <b>Mirage</b> , FABRIC <b>Cotton Club</b> , FABRIC <b>Renewed Loop</b>  | <b>TB</b> | FAUX LEATHER <b>Vintage</b> , FABRIC <b>Fenix Wool</b> , FABRIC <b>Visual</b> , FABRIC <b>Manhattan</b> , FABRIC <b>Novabuk</b> , FABRIC <b>Network</b> , FABRIC <b>Gyre</b> |
| <b>TC</b> | VELVET SUPERB, FABRIC <b>Second</b> , FABRIC <b>Main Line Flax</b> , FABRIC <b>Oceanic</b> , FABRIC <b>Jumper</b> , FABRIC <b>Flame</b> , FABRIC <b>Ouche</b> , FABRIC <b>Plain</b> , FABRIC <b>Gemma</b> , FABRIC <b>Caltagirone II4</b> | <b>TD</b> | FABRIC <b>Yoredale</b> , FABRIC <b>Remix 3</b>   |
| <b>TE</b> | FABRIC <b>Uniform Melange</b>   | <b>SF</b> | LEATHER <b>Fiore</b>   |
| <b>SV</b> | LEATHER <b>Vintage</b>  |           |  |

**COM/COL - Minimum Q.ty 6 pc. for each material. For weft or patterned fabrics see specific pages**

|            |                        |            |               |
|------------|------------------------|------------|---------------|
| <b>COM</b> | Mtl. 0.85 h. 1.40 Each | <b>COL</b> | Mq. 1.76 Each |
|------------|------------------------|------------|---------------|

### Optionals:

|              | Value  | Options/notes  |
|--------------|--------|--|
| <b>FM-M2</b> | + 58 € | ASH GREY <b>ES</b> , BLUE SAPPHIRE <b>EE</b> , BLUE TURQUOISE <b>EH</b> , BRONZE <b>E2</b> , BULGARO RED <b>FP</b> , CHERRY RED <b>EQ</b> , DARK GREEN <b>EL</b> , FACEPOWDER PINK <b>E8</b> , FANGO <b>E3</b> , GOLDEN YELLOW <b>EO</b> , LIGHT BLUE <b>EO</b> , LIGHT GREY <b>ET</b> , OCEAN BLUE <b>E1</b> , OCHER YELLOW <b>E7</b> , PAPAYA ORANGE <b>EA</b> , PASTEL YELLOW <b>E4</b> , PINE GREEN <b>EJ</b> , RED <b>ER</b> , SAGE GREEN <b>E9</b> |
| <b>ES-1</b>  | + 6 €  | ES-1   |

### Wrap SG

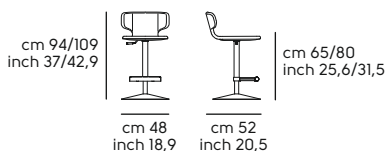

# Yak design Nicola Bonriposi

## Yak - Seat Back and armrest in fabric

| Model  | Code    | Mod. | Upholstery |       |       |       |       | Optional | Q.ty | boxes | Kg | M <sup>3</sup> |
|--|---------|------|------------|-------|-------|-------|-------|----------|------|-------|----|----------------|
|  |         |      | TA         | TB    | TC    | TD    | COM   |          |      |       |    |                |
|  <b>Seat YAK S</b> | S2380B2 | S    | 790 €      | 838 € | 914 € | 982 € | 790 € |          | 1    | 1     | 16 | 0.28           |

COM/COL - Minimum Q.ty 6 pc. for each material. For weft or patterned fabrics see specific pages

|   |  |
|---|--|
|  Mtl. 2.30 h. 1.40 Each |  |
|---|--|

| Model  | Code    | Mod. | Upholstery |       |       |       |       | Optional | Q.ty | boxes | Kg | M <sup>3</sup> |
|--|---------|------|------------|-------|-------|-------|-------|----------|------|-------|----|----------------|
|  |         |      | TA         | TB    | TC    | TD    | COM   |          |      |       |    |                |
|  <b>Backrest-Armrests YAK SB</b> | S2380SB | SB   | 660 €      | 708 € | 784 € | 852 € | 660 € |          | 1    | 1     | 11 | 0.23           |

COM/COL - Minimum Q.ty 6 pc. for each material. For weft or patterned fabrics see specific pages

|   |  |
|---|--|
|  Mtl. 1.90 h. 1.40 Each |  |
|---|--|

| Model   | Code      | Mod. | Upholstery |         |         |         |         | Optional | Q.ty | boxes | Kg  | M <sup>3</sup> |
|---|-----------|------|------------|---------|---------|---------|---------|----------|------|-------|-----|----------------|
|   |           |      | TA         | TB      | TC      | TD      | COM     |          |      |       |     |                |
|  <b>YAK S1 Without Armrests</b> | S23801S10 |      | 1.450 €    | 1.546 € | 1.698 € | 1.834 € | 1.450 € |          | 1    | 2     | 27  | 0.51           |
|  <b>YAK S2 With Armrests</b>    | S23802S22 |      | 4.220 €    | 4.508 € | 4.964 € | 5.372 € | 4.220 € |          | 1    | 6     | 76  | 1.48           |
|  <b>YAK S3 With Armrests</b>    | S23803S32 |      | 5.670 €    | 6.054 € | 6.662 € | 7.206 € | 5.670 € |          | 1    | 8     | 103 | 1.99           |

Note:

**Shell finishes**

**Upholstery**

|           |   |           |  |
|-----------|---|-----------|--|
| <b>TA</b> | FABRIC <b>Mirage</b> , FABRIC <b>Cotton Club</b> , FABRIC <b>Renewed Loop</b>   | <b>TB</b> | FABRIC <b>Fenix Wool</b> , FABRIC <b>Visual</b> , FABRIC <b>Manhattan</b> , FABRIC <b>Novabuk</b> , FABRIC <b>Network</b> , FABRIC <b>Gyre</b> |
| <b>TC</b> | VELVET SUPERB, FABRIC <b>Second</b> , FABRIC <b>Main Line Flax</b> , FABRIC <b>Oceanic</b> , FABRIC <b>Jumper</b> , FABRIC <b>Flame</b> , FABRIC <b>Ouche</b> , FABRIC <b>Plain</b> , FABRIC <b>Gemma</b> , FABRIC <b>Caltagirone 114</b> | <b>TD</b> | FABRIC <b>Yoredale</b> , FABRIC <b>Remix 3</b>   |

**Seat YAK S**

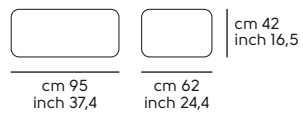

**Backrest-Armrests YAK SB**

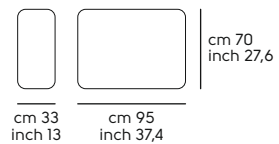

# Tables

# Akashi design Paolo Vernier

## Table Akashi

Frame with bases in: aluminum - Tables with tops in Glass or Ceramic are suitable for Outdoor



| Version           | Code     | Legs | Frame | Top     | Optional | Q.ty | boxes | Kg   | M <sup>3</sup> |
|-------------------|----------|------|-------|---------|----------|------|-------|------|----------------|
| <b>Akashi MDF</b> |          |      |       |         |          |      |       |      |                |
| Top 19 mm. thk    |          |      |       |         |          |      |       |      |                |
|                   |          |      |       | LM1     |          |      |       |      |                |
| 140x140           | T2230140 | M1   | M1    | 2.410 € | FM-M2    | 1    | 2     | 67.5 | 0.41           |
| 160x 90           | T2230160 |      |       | 2.104 € |          | 1    | 2     | 57.5 | 0.31           |
| 180x100           | T2230180 |      |       | 2.322 € |          | 1    | 2     | 66   | 0.38           |
| 200x100           | T2230200 |      |       | 2.517 € |          | 1    | 2     | 69   | 0.45           |

## Akashi Veneer

Top 19 mm. thk

|         |          |    |    | LI1     | LI2     |       |   |   |      |      |
|---------|----------|----|----|---------|---------|-------|---|---|------|------|
| 140x140 | T2230140 | M1 | M1 | 2.678 € | 2.854 € | FM-M2 | 1 | 2 | 62   | 0.41 |
| 160x 90 | T2230160 |    |    | 2.111 € | 2.332 € |       | 1 | 2 | 53.5 | 0.31 |
| 180x100 | T2230180 |    |    | 2.460 € | 2.596 € |       | 1 | 2 | 60   | 0.38 |
| 200x100 | T2230200 |    |    | 2.716 € | 2.862 € |       | 1 | 2 | 63   | 0.45 |
| 300x120 | T2230300 |    |    | 4.045 € | 4.233 € |       | 1 | 2 | 90   | 0.88 |

## Akashi HPL

Top 10 mm. thk

|         |          |    |    | HH1     | HH2     | HH3     |       |   |   |     |      |
|---------|----------|----|----|---------|---------|---------|-------|---|---|-----|------|
| 140x140 | T2230140 | M1 | M1 | 2.880 € | 2.940 € | 3.490 € | FM-M2 | 1 | 2 | 72  | 0.41 |
| 160x 90 | T2230160 |    |    | 2.580 € | 2.650 € | 2.970 € |       | 1 | 2 | 58  | 0.31 |
| 180x100 | T2230180 |    |    | 2.700 € | 2.774 € | 3.100 € |       | 1 | 2 | 69  | 0.38 |
| 200x100 | T2230200 |    |    | 2.920 € | 2.990 € | 3.280 € |       | 1 | 2 | 74  | 0.45 |
| 300x120 | T2230300 |    |    | 3.810 € | 3.890 € | 4.350 € |       | 1 | 2 | 110 | 0.88 |

## Akashi Glass

Top 6 mm. thk

|         |          |    |    | GVB     | GVC     | GVD     |       |   |   |      |      |
|---------|----------|----|----|---------|---------|---------|-------|---|---|------|------|
| 140x140 | T2230140 | M1 | M1 | 2.098 € | 2.194 € | 2.341 € | FM-M2 | 1 | 2 | 72   | 0.41 |
| 160x 90 | T2230160 |    |    | 1.875 € | 1.976 € | 2.053 € |       | 1 | 2 | 62   | 0.31 |
| 180x100 | T2230180 |    |    | 2.066 € | 2.194 € | 2.290 € |       | 1 | 2 | 69.5 | 0.38 |
| 200x100 | T2230200 |    |    | 2.229 € | 2.372 € | 2.479 € |       | 1 | 2 | 73.5 | 0.45 |
| 300x120 | T2230300 |    |    | 3.038 € | 3.288 € | 3.479 € |       | 1 | 2 | 108  | 0.88 |

## Akashi Ceramic

Top 6 mm. thk

|         |          |    |    | GKA     | GKB     | GMA     |       |   |   |       |      |
|---------|----------|----|----|---------|---------|---------|-------|---|---|-------|------|
| 160x 90 | T2230160 | M1 | M1 | 2.874 € | 2.919 € | 3.084 € | FM-M2 | 1 | 2 | 90    | 0.31 |
| 180x100 | T2230180 |    |    | 3.090 € | 3.254 € | 3.540 € |       | 1 | 2 | 106.5 | 0.38 |
| 200x100 | T2230200 |    |    | 3.639 € | 3.669 € | 3.895 € |       | 1 | 2 | 115   | 0.45 |
| 300x120 | T2230300 |    |    | 4.927 € | 5.039 € | 5.332 € |       | 1 | 2 | 186   | 0.88 |

**Note:**

Top 180x100 / 200x100 NO Ceramic K26 - Top 300x120 NO Ceramic K26-K90-K91

**Frame finishes****Metal****MI** WHITE **BB**, BROWN **E6**, SAND **EC**, WHITE PEARL **EF**, GRAPHITE **EG**, BLACK **EN****Legs finishes****Metal****MI** WHITE **BB**, BROWN **E6**, SAND **EC**, WHITE PEARL **EF**, GRAPHITE **EG**, BLACK **EN****Top finishes****Lacquared MDF****LMI** GRAPHITE GREY **G02**, BLACK **G04**, WHITE **G05**, SAND **G07**, BROWN **G41****Veneer****L11** Stained WHITENED **I60**, Stained DESERT **I61**, Stained LIGHT GREY **I62**, Stained DARK GREY **I63****L12** NATURAL OAK **I22**, FLAMED WALNUT **I24****HPL****HH1** WHITE/Black Core **HB4**, BLACK/Black Core **HN4****HH2** CEMENT/Black Core **HC6**, CORTEN/Brown Core **HC7**, DARK GREY/Black Core **HGW****HH3** ST WHITE/White Core **AB4**, ST SAND/Sand Core **ACR**, ST GRAPHITE GREY/ Grafite Core **AGD**, ST BLACK/Black Core **AN4**, ST TORTORA/Tortora Core **ATR**, ST RED NAMIB/Red Core **FAM**, ST YELLOW EVORA/Yellow Core **FGO**, ST RED BULGARO/Red Core **FRB**, ST GREEN KITAMI/Green Core **FVK****Crystal Ceramic and Ceramic****GKA** CHARCOAL SAVOIA **K11**, CEMENT SAVOIA **K12****GKB** WHITE CALCE **K24**, BLACK CALCE **K25**, TORTORA CALCE **K26**, PIASENTINA STONE TAUPE Materica **K55**,**GMA** MARBLE CALACATTA GLOSSY WHITE **K32**, BLACK GREEK MARBLE **K33**, MARBLE GLOSSY NOIR DESIR **K35**, MARBLE CALACATTA MATT WHITE **K42**, MARBLE MATT NOIR DESIR **K45**, MARBLE MATT GREEN TINOS **K46**, MARBLE STATUARIO WHITE MATT **K47**, MARBLE CALACAT BLACK Bush Hammered **K50****Satin Glass****GVC** MATT GRAFITE ANTISCRATCH **J31**, MATT SAND ANTISCRATCH **J32****GVD** EXTRA CLEAR MATT WHITE ANTISCRATCH **J41****Glossy Glass****GVB** EXTRA CLEAR GLOSSY WHITE **J21**, EXTRA CLEAR GLOSSY CHERRY RED **J25**, EXTRA CLEAR GLOSSY BLUE SAPPHIRE **J26**, EXTRA CLEAR GLOSSY BLUE TURQUOISE **J27****Optionals:**

|              |                      | Value   | Options/notes  |
|--------------|----------------------|---------|--|
| <b>FM-M2</b> | Indoor matt metal M2 | + 158 € | ASH GREY <b>ES</b> , BLUE SAPPHIRE <b>EE</b> , BLUE TURQUOISE <b>EH</b> , BRONZE <b>E2</b> , BULGARO RED <b>FP</b> , CHERRY RED <b>EQ</b> , DARK GREEN <b>EL</b> , FACEPOWDER PINK <b>E8</b> , FANGO <b>E3</b> , GOLDEN YELLOW <b>EO</b> , LIGHT BLUE <b>EO</b> , LIGHT GREY <b>ET</b> , OCEAN BLUE <b>E1</b> , OCHER YELLOW <b>E7</b> , PAPAYA ORANGE <b>EA</b> , PASTEL YELLOW <b>E4</b> , PINE GREEN <b>EJ</b> , RED <b>ER</b> , SAGE GREEN <b>E9</b> |

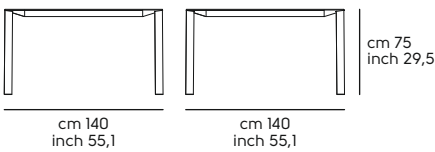
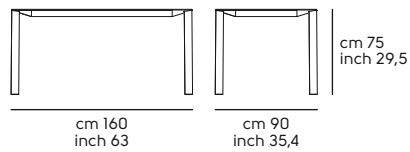
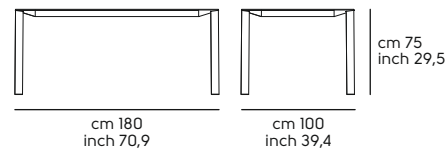
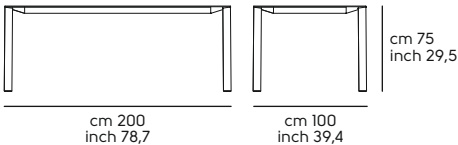
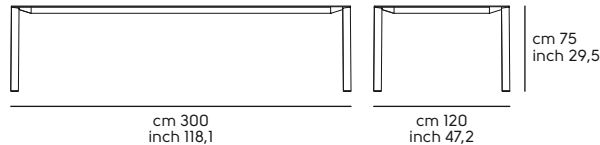
**140x140****160x 90****180x100****200x100****300x120**

# Alexander design Officina delle Idee

## Table Alexander

Frame in: metal



| Version | Code | Legs | Frame | Top | Optional | Q.ty | boxes | Kg | M <sup>3</sup> |
|---------|------|------|-------|-----|----------|------|-------|----|----------------|
|---------|------|------|-------|-----|----------|------|-------|----|----------------|

### Alexander wood

Top 40 mm. thk

|         |          |    |    | LS1     | LS2     |  |   |   |     |      |
|---------|----------|----|----|---------|---------|--|---|---|-----|------|
| 200x106 | T1774200 | M1 | M1 | 3.007 € | 3.500 € |  | 1 | 3 | 117 | 0.69 |
| 250x106 | T1774250 |    |    | 3.591 € | 4.145 € |  | 1 | 3 | 130 | 0.80 |

### Alexander Ceramic

Top 16 mm. thk

|                |          |    |    | GMA     |  |  |   |   |     |      |
|----------------|----------|----|----|---------|--|--|---|---|-----|------|
| 220x116 Barrel | T1775220 | M1 | M1 | 3.639 € |  |  | 1 | 3 | 138 | 0.37 |
| 250x120 Barrel | T1775250 |    |    | 4.308 € |  |  | 1 | 3 | 151 | 0.39 |

| Version | Code | Legs | Frame | Top and extensions | Optional | Q.ty | boxes | Kg | M <sup>3</sup> |
|---------|------|------|-------|--------------------|----------|------|-------|----|----------------|
|---------|------|------|-------|--------------------|----------|------|-------|----|----------------|

### Alexander Glass

Top and extensions 10 mm. thk

|             |          |    |    | GVC     |  |  |   |   |     |      |
|-------------|----------|----|----|---------|--|--|---|---|-----|------|
| 160/240x 90 | T1776160 | M1 | M1 | 2.835 € |  |  | 1 | 4 | 112 | 0.44 |
| 200/300x100 | T1776200 |    |    | 3.472 € |  |  | 1 | 4 | 136 | 0.75 |

### Alexander Ceramic

Top and extensions 11 mm. thk | ATTENTION ! GMA: Top and Extensions 14 mm. thk

|             |          |    |    | GKA     | GKB     | GMA     |  |   |   |     |      |
|-------------|----------|----|----|---------|---------|---------|--|---|---|-----|------|
| 160/240x 90 | T1776160 | M1 | M1 | 3.450 € | 3.582 € | 3.936 € |  | 1 | 4 | 112 | 0.44 |
| 200/300x100 | T1776200 |    |    | 4.266 € | 4.413 € | 4.944 € |  | 1 | 4 | 136 | 0.75 |

### Note:

For Glass or Crystal Ceramic tops, extensions in the same material - Top 200x100 NO Ceramic K26

**Frame finishes**

|              |   |
|--------------|---|
| <b>Metal</b> |   |
| <b>MI</b>    | WHITE <b>BB</b> , BROWN <b>E6</b> , SAND <b>EC</b> , WHITE PEARL <b>EF</b> , GRAPHITE <b>EG</b> , BLACK <b>EN</b> |

**Legs finishes**

|              |   |
|--------------|---|
| <b>Metal</b> |   |
| <b>MI</b>    | WHITE <b>BB</b> , BROWN <b>E6</b> , SAND <b>EC</b> , WHITE PEARL <b>EF</b> , GRAPHITE <b>EG</b> , BLACK <b>EN</b> |

**Top and extensions finishes**

|                      |                                   |
|----------------------|-----------------------------------|
| <b>Solid ashwood</b> |                                   |
| <b>LS1</b>           | IM OAK STRAIGHT EDGE <b>WR1</b>   |
| <b>LS2</b>           | SOLID WALNUT BARK EDGE <b>WN1</b> |

|                    |  |
|--------------------|--|
| <b>Satin Glass</b> |  |
| <b>GVC</b>         | MATT GRAFITE ANTISCRATCH <b>J31</b> , MATT SAND ANTISCRATCH <b>J32</b> |

|                                    |  |
|------------------------------------|--|
| <b>Crystal Ceramic and Ceramic</b> |  |
| <b>GKA</b>                         | CHARCOAL SAVOIA <b>K11</b> , CEMENT SAVOIA <b>K12</b>  |
| <b>GKB</b>                         | WHITE CALCE <b>K24</b> , BLACK CALCE <b>K25</b> , TORTORA CALCE <b>K26</b> , PIASENTINA STONE TAUPE Materica <b>K55</b> , TERRACOTTA Matt <b>K90</b> , MATT GREEN <b>K91</b> |

|                                    |   |
|------------------------------------|---|
| <b>Crystal Ceramic and Ceramic</b> |   |
| <b>GMA</b>                         | MARBLE CALACATTA GLOSSY WHITE <b>K32</b> , BLACK GREEK MARBLE <b>K33</b> , MARBLE GLOSSY NOIR DESIR <b>K35</b> , MARBLE CALACATTA MATT WHITE <b>K42</b> , MARBLE MATT NOIR DESIR <b>K45</b> , MARBLE MATT GREEN TINOS <b>K46</b> , MARBLE STATUARIO WHITE MATT <b>K47</b> , MARBLE CALACAT BLACK Bush Hammered <b>K50</b> |

**200x106**

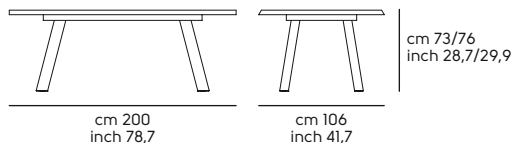

**250x106**

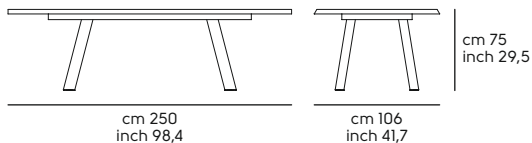

**220x116 Barrel**

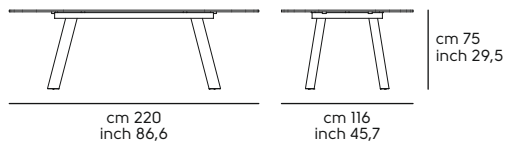

**250x120 Barrel**

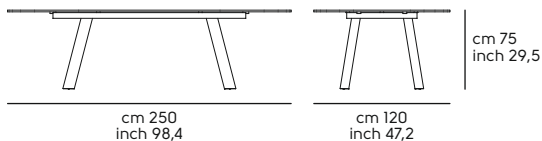

**160/240x 90**

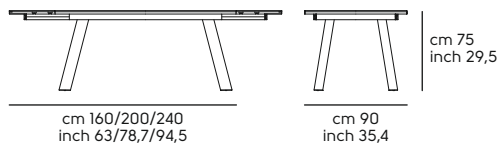

**200/300x100**

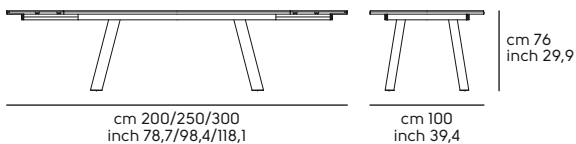

# Alfred design Officina delle Idee

## Table Alfred

Frame in: metal



| Version | Code | Legs | Frame | Top | Optional | Q.ty | boxes | Kg | M <sup>3</sup> |
|---------|------|------|-------|-----|----------|------|-------|----|----------------|
|---------|------|------|-------|-----|----------|------|-------|----|----------------|

### Alfred wood

Top 40 mm. thk

|         |          |    |    | LS1     | LS2     |  |   |   |     |      |
|---------|----------|----|----|---------|---------|--|---|---|-----|------|
| 200x106 | T1760200 | M1 | M1 | 3.135 € | 3.623 € |  | 1 | 4 | 113 | 0.39 |
| 250x106 | T1760250 |    |    | 3.720 € | 4.267 € |  | 1 | 4 | 126 | 0.45 |

### Alfred Ceramic

Top 16 mm. thk

|                |          |    |    | GMA     |  |  |   |   |     |      |
|----------------|----------|----|----|---------|--|--|---|---|-----|------|
| 220x116 Barrel | T1761220 | M1 | M1 | 3.754 € |  |  | 1 | 4 | 155 | 0.69 |
| 250x120 Barrel | T1761250 |    |    | 4.424 € |  |  | 1 | 4 | 164 | 0.65 |

| Version | Code | Legs | Frame | Top and extensions | Optional | Q.ty | boxes | Kg | M <sup>3</sup> |
|---------|------|------|-------|--------------------|----------|------|-------|----|----------------|
|---------|------|------|-------|--------------------|----------|------|-------|----|----------------|

### Alfred Glass

Top and extensions 10 mm. thk

|             |          |    |    | GVC     |  |  |   |   |     |      |
|-------------|----------|----|----|---------|--|--|---|---|-----|------|
| 160/240x 90 | T1762160 | M1 | M1 | 2.957 € |  |  | 1 | 5 | 129 | 0.68 |
| 200/300x100 | T1762200 |    |    | 3.603 € |  |  | 1 | 5 | 153 | 0.87 |

### Alfred Ceramic

Top and extensions 11 mm. thk | ATTENTION ! GMA: Top and Extensions 14 mm. thk

|             |          |    |    | GKA     | GKB     | GMA     |  |   |   |     |      |
|-------------|----------|----|----|---------|---------|---------|--|---|---|-----|------|
| 160/240x 90 | T1762160 | M1 | M1 | 3.568 € | 3.709 € | 4.060 € |  | 1 | 5 | 129 | 0.68 |
| 200/300x100 | T1762200 |    |    | 4.379 € | 4.532 € | 5.072 € |  | 1 | 5 | 153 | 0.87 |

### Note:

For Glass or Crystal Ceramic tops, extensions in the same material - Top 200x100 NO Ceramic K26

**Frame finishes**

|              |   |
|--------------|---|
| <b>Metal</b> |   |
| <b>MI</b>    | WHITE <b>BB</b> , BROWN <b>E6</b> , SAND <b>EC</b> , WHITE PEARL <b>EF</b> , GRAPHITE <b>EG</b> , BLACK <b>EN</b> |

**Legs finishes**

|              |   |
|--------------|---|
| <b>Metal</b> |   |
| <b>MI</b>    | WHITE <b>BB</b> , BROWN <b>E6</b> , SAND <b>EC</b> , WHITE PEARL <b>EF</b> , GRAPHITE <b>EG</b> , BLACK <b>EN</b> |

**Top and extensions finishes**

|                      |                                   |
|----------------------|-----------------------------------|
| <b>Solid ashwood</b> |                                   |
| <b>LS1</b>           | IM OAK STRAIGHT EDGE <b>WR1</b>   |
| <b>LS2</b>           | SOLID WALNUT BARK EDGE <b>WN1</b> |

|                    |  |
|--------------------|--|
| <b>Satin Glass</b> |  |
| <b>GVC</b>         | MATT GRAFITE ANTISCRATCH <b>J31</b> , MATT SAND ANTISCRATCH <b>J32</b> |

|                                    |  |
|------------------------------------|--|
| <b>Crystal Ceramic and Ceramic</b> |  |
| <b>GKA</b>                         | CHARCOAL SAVOIA <b>K11</b> , CEMENT SAVOIA <b>K12</b>  |
| <b>GKB</b>                         | WHITE CALCE <b>K24</b> , BLACK CALCE <b>K25</b> , TORTORA CALCE <b>K26</b> , PIASENTINA STONE TAUPE Materica <b>K55</b> , TERRACOTTA Matt <b>K90</b> , MATT GREEN <b>K91</b> |

|                                    |   |
|------------------------------------|---|
| <b>Crystal Ceramic and Ceramic</b> |   |
| <b>GMA</b>                         | MARBLE CALACATTA GLOSSY WHITE <b>K32</b> , BLACK GREEK MARBLE <b>K33</b> , MARBLE GLOSSY NOIR DESIR <b>K35</b> , MARBLE CALACATTA MATT WHITE <b>K42</b> , MARBLE MATT NOIR DESIR <b>K45</b> , MARBLE MATT GREEN TINOS <b>K46</b> , MARBLE STATUARIO WHITE MATT <b>K47</b> , MARBLE CALACAT BLACK Bush Hammered <b>K50</b> |

**200x106**

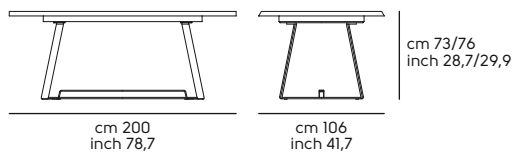

**250x106**

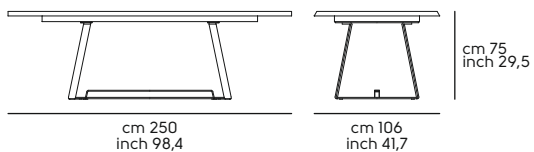

**220x116 Barrel**

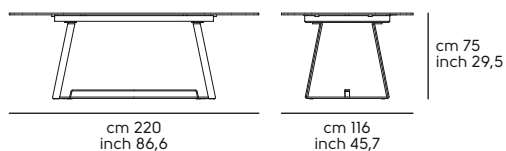

**250x120 Barrel**

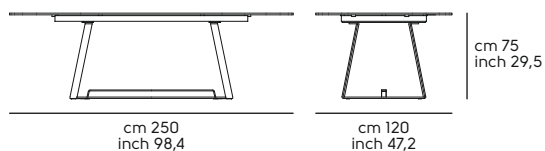

**160/240x 90**

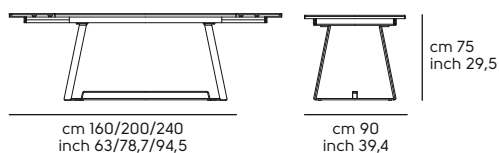

**200/300x100**

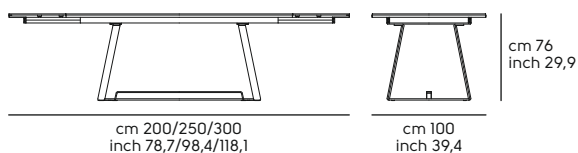

# Apollo design Studio Kappa

## Table Apollo

Frame in: metal



| Version | Code | Legs | Frame | Top and extensions | Optional | Q.ty | boxes | Kg | M <sup>3</sup> |
|---------|------|------|-------|--------------------|----------|------|-------|----|----------------|
|---------|------|------|-------|--------------------|----------|------|-------|----|----------------|

### Apollo Melamine HL

Top and extensions 18 mm. thk

|                 |          |    |    | HL1     |       |   |   |    |      |
|-----------------|----------|----|----|---------|-------|---|---|----|------|
| 140/190 x90     | T0110140 | M1 | M1 | 1.587 € | FM-M2 | 1 | 4 | 69 | 0.32 |
| 160/210/260 x90 | T0110160 |    |    | 1.690 € |       | 1 | 5 | 84 | 0.34 |

### Apollo MDF

Top and extensions 19 mm. thk

|                 |          |    |    | LM1     |       |   |   |    |      |
|-----------------|----------|----|----|---------|-------|---|---|----|------|
| 140/190 x90     | T0110140 | M1 | M1 | 2.154 € | FM-M2 | 1 | 4 | 69 | 0.32 |
| 160/210/260 x90 | T0110160 |    |    | 2.273 € |       | 1 | 5 | 84 | 0.34 |

### Apollo Veneer

Top and extensions 19 mm. thk

|                 |          |    |    | LI2     |       |   |   |    |      |
|-----------------|----------|----|----|---------|-------|---|---|----|------|
| 140/190 x90     | T0110140 | M1 | M1 | 2.380 € | FM-M2 | 1 | 4 | 69 | 0.32 |
| 160/210/260 x90 | T0110160 |    |    | 2.627 € |       | 1 | 5 | 84 | 0.34 |

### Apollo Glass

Glass top 10 mm. thk MDF extensions 19 mm. thk

|                 |          |    |    | GVB     | GVC     | GVD     |       |   |   |     |      |
|-----------------|----------|----|----|---------|---------|---------|-------|---|---|-----|------|
| 140/190 x90     | T0110140 | M1 | M1 | 2.283 € | 2.402 € | 2.614 € | FM-M2 | 1 | 4 | 80  | 0.32 |
| 160/210/260 x90 | T0110160 |    |    | 2.404 € | 2.548 € | 2.783 € |       | 1 | 5 | 97  | 0.34 |
| 190/240/290 x90 | T0110190 |    |    | 2.678 € | 2.755 € | 3.030 € |       | 1 | 5 | 107 | 0.40 |

### Apollo Ceramic

Ceramic top 11 mm thk 19 mm. thk MDF extensions | ATTENTION! GMA: Top Th. 14 mm. and Extensions Thk 22 mm.

|                 |          |    |    | GKA     | GKB     | GMA     |       |   |   |     |      |
|-----------------|----------|----|----|---------|---------|---------|-------|---|---|-----|------|
| 140/190 x90     | T0110140 | M1 | M1 | 2.590 € | 2.742 € | 2.923 € | FM-M2 | 1 | 4 | 80  | 0.32 |
| 160/210/260 x90 | T0110160 |    |    | 2.780 € | 2.971 € | 3.271 € |       | 1 | 5 | 97  | 0.34 |
| 190/240/290 x90 | T0110190 |    |    | 3.156 € | 3.363 € | 3.800 € |       | 1 | 5 | 107 | 0.40 |

#### Note:

For Glass or Crystal Ceramic tops, extensions Only in MDF

**Frame finishes**

| Metal     |   |
|-----------|---|
| <b>MI</b> | WHITE <b>BB</b> , BROWN <b>E6</b> , SAND <b>EC</b> , WHITE PEARL <b>EF</b> , GRAPHITE <b>EG</b> , BLACK <b>EN</b> |

**Legs finishes**

| Metal     |   |
|-----------|---|
| <b>MI</b> | WHITE <b>BB</b> , BROWN <b>E6</b> , SAND <b>EC</b> , WHITE PEARL <b>EF</b> , GRAPHITE <b>EG</b> , BLACK <b>EN</b> |

**Top and extensions finishes**

| Melamine   |  |
|------------|--|
| <b>HLI</b> | WHITE <b>M01</b> , GRAFITE <b>M02</b> , BLACK <b>M04</b> , SAND <b>M07</b> |

| Veneer     |   |
|------------|---|
| <b>LI2</b> | NATURAL OAK <b>I22</b> , FLAMED WALNUT <b>I24</b> |

| Lacquered MDF |   |
|---------------|---|
| <b>LMI</b>    | GRAPHITE GREY <b>G02</b> , BLACK <b>G04</b> , WHITE <b>G05</b> , SAND <b>G07</b> , BROWN <b>G41</b> |

**Top finishes with matching lacquered MDF extensions**

| Satin Glass |  |
|-------------|--|
| <b>GVC</b>  | MATT GRAFITE ANTISCRATCH <b>J31</b> , MATT SAND ANTISCRATCH <b>J32</b> |
| <b>GVD</b>  | EXTRA CLEAR MATT WHITE ANTISCRATCH <b>J41</b>                          |

| Glossy Glass |  |
|--------------|--|
| <b>GVB</b>   | EXTRA CLEAR GLOSSY WHITE <b>J21</b> , EXTRA CLEAR GLOSSY BLUE SAPPHIRE <b>J26</b> , EXTRA CLEAR GLOSSY BLUE TURQUOISE <b>J27</b> |

| Crystal Ceramic and Ceramic |  |
|-----------------------------|--|
| <b>GKA</b>                  | CHARCOAL SAVOIA <b>K11</b> , CEMENT SAVOIA <b>K12</b>  |
| <b>GKB</b>                  | WHITE CALCE <b>K24</b> , BLACK CALCE <b>K25</b> , TORTORA CALCE <b>K26</b> , PIASENTINA STONE TAUPE Materica <b>K55</b> , TERRACOTTA Matt <b>K90</b> , MATT GREEN <b>K91</b> |

| Crystal Ceramic and Ceramic |   |
|-----------------------------|---|
| <b>GMA</b>                  | MARBLE CALACATTA GLOSSY WHITE <b>K32</b> , BLACK GREEK MARBLE <b>K33</b> , MARBLE GLOSSY NOIR DESIR <b>K35</b> , MARBLE CALACATTA MATT WHITE <b>K42</b> , MARBLE MATT NOIR DESIR <b>K45</b> , MARBLE MATT GREEN TINOS <b>K46</b> , MARBLE STATUARIO WHITE MATT <b>K47</b> , MARBLE CALACAT BLACK Bush Hammered <b>K50</b> |

**Extensions finishes MDF, ONLY for Glass and Ceramic Top**

| Lacquered MDF |   |
|---------------|---|
| <b>LMI</b>    | GRAPHITE GREY <b>G02</b> , BLACK <b>G04</b> , WHITE <b>G05</b> , SAND <b>G07</b> , BROWN <b>G41</b> |

**Optionals:**

|              |                      | Value   | Options/notes  |
|--------------|----------------------|---------|--|
| <b>FM-M2</b> | Indoor matt metal M2 | + 164 € | ASH GREY <b>ES</b> , BLUE SAPPHIRE <b>EE</b> , BLUE TURQUOISE <b>EH</b> , BRONZE <b>E2</b> , BULGARO RED <b>FP</b> , CHERRY RED <b>EQ</b> , DARK GREEN <b>EL</b> , FACEPOWDER PINK <b>E8</b> , FANGO <b>E3</b> , GOLDEN YELLOW <b>EO</b> , LIGHT BLUE <b>EO</b> , LIGHT GREY <b>ET</b> , OCEAN BLUE <b>E1</b> , OCHER YELLOW <b>E7</b> , PAPAYA ORANGE <b>EA</b> , PASTEL YELLOW <b>E4</b> , PINE GREEN <b>EJ</b> , RED <b>ER</b> , SAGE GREEN <b>E9</b> |

**140/190 x90**

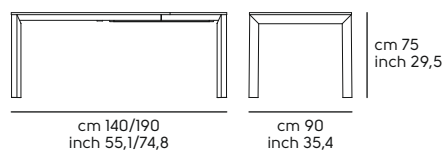

**160/210/260 x90**

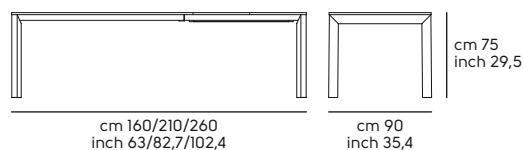

**190/240/290 x90**

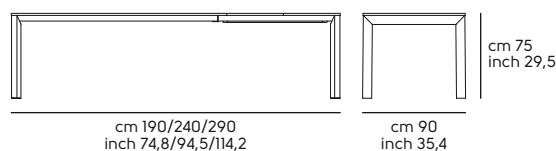

# Armando design Balutto Associati

## Table Armando

Frame in: metal



| Version | Code | Legs | Frame | Top | Optional | Q.ty | boxes | Kg | M <sup>3</sup> |
|---------|------|------|-------|-----|----------|------|-------|----|----------------|
|---------|------|------|-------|-----|----------|------|-------|----|----------------|

### Armando Metal

Top 17 mm. thk

|               |          |    |    | M1      |  |   |   |     |      |
|---------------|----------|----|----|---------|--|---|---|-----|------|
| 80 x80        | T0120Q80 |    |    | 919 €   |  | 1 | 2 | 30  | 0.15 |
| 90 x90        | T0120Q90 |    |    | 1.035 € |  | 1 | 2 | 35  | 0.16 |
| 160x90        | T0120160 |    |    | 1.506 € |  | 1 | 2 | 49  | 0.23 |
| 200x100       | T0120200 |    |    | 1.646 € |  | 1 | 2 | 62  | 0.28 |
| 280x100       | T0120280 | M1 | M1 | 2.438 € |  | 1 | 2 | 98  | 0.38 |
| 80 x80 H.110  | T0127Q80 |    |    | 1.021 € |  | 1 | 2 | 36  | 0.15 |
| 90 x90 H.110  | T0127Q90 |    |    | 1.137 € |  | 1 | 2 | 37  | 0.19 |
| 160x90 H.110  | T0127160 |    |    | 1.608 € |  | 1 | 2 | 54  | 0.25 |
| 200x100 H.110 | T0127200 |    |    | 1.749 € |  | 1 | 2 | 68  | 0.29 |
| 280x100 H.110 | T0127280 |    |    | 2.527 € |  | 1 | 2 | 103 | 0.42 |

**Frame finishes**

**Metal**

|           |                    |
|-----------|--------------------|
| <b>MI</b> | WHITE BB, BLACK EN |
|-----------|--------------------|

**Top finishes**

**Metal**

|           |                    |
|-----------|--------------------|
| <b>MI</b> | WHITE BB, BLACK EN |
|-----------|--------------------|

**Legs finishes**

**Metal**

|           |                    |
|-----------|--------------------|
| <b>MI</b> | WHITE BB, BLACK EN |
|-----------|--------------------|

**80 x80**

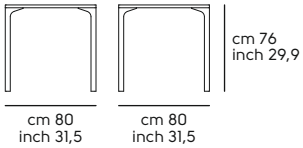

**90 x90**

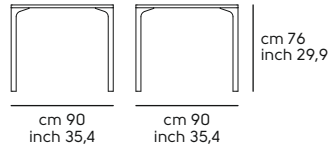

**160x90**

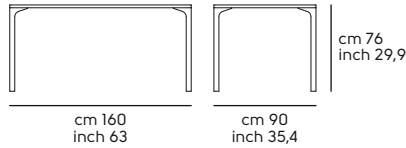

**200x100**

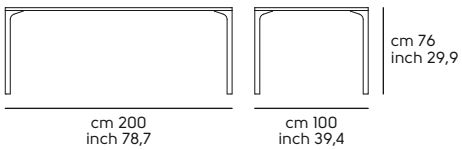

**280x100**

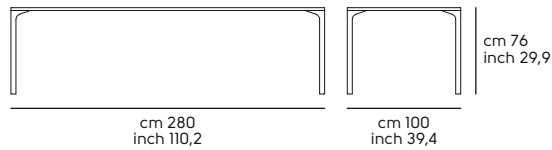

**80 x80 H.110**

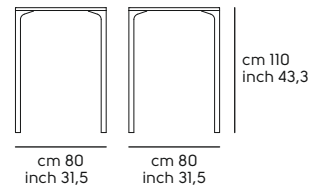

**90 x90 H.110**

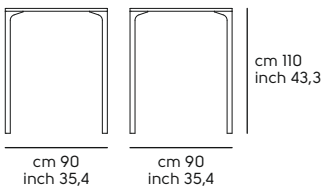

**160x90 H.110**

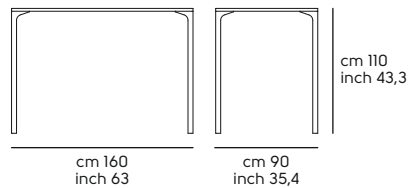

**200x100 H.110**

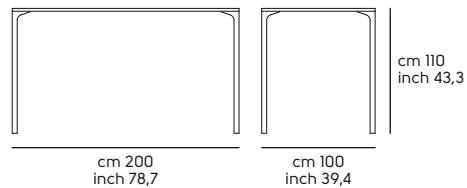

**280x100 H.110**

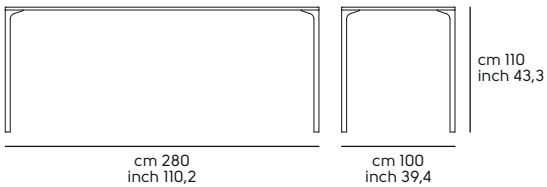

# Badù design Studio Kappa

## Table Badù

Frame in: metal



| Version | Code | Legs | Frame | Top | Optional | Q.ty | boxes | Kg | M <sup>3</sup> |
|---------|------|------|-------|-----|----------|------|-------|----|----------------|
|---------|------|------|-------|-----|----------|------|-------|----|----------------|

### Badù Melamine HL

Top 18 mm. thk

|         |          |    |    | HL1   |       |   |   |      |      |
|---------|----------|----|----|-------|-------|---|---|------|------|
| 100x 70 | T0130010 |    |    | 490 € | FM-M2 | 1 | 3 | 33.5 | 0.16 |
| 110x 80 | T0130011 |    |    | 590 € |       | 1 | 3 | 37.5 | 0.20 |
| 120x 80 | T0130012 | M1 | M1 | 625 € |       | 1 | 3 | 38   | 0.20 |
| 140x 90 | T0130014 |    |    | 710 € |       | 1 | 3 | 43.5 | 0.25 |
| 160x 90 | T0130016 |    |    | 830 € |       | 1 | 3 | 45   | 0.30 |
| 180x 90 | T0130018 |    |    | 950 € |       | 1 | 3 | 52   | 0.34 |

### Badù MDF

Top 19 mm. thk

|         |          |    |    | LM1     |       |   |   |      |      |
|---------|----------|----|----|---------|-------|---|---|------|------|
| 100x 70 | T0130010 |    |    | 690 €   | FM-M2 | 1 | 3 | 33.5 | 0.16 |
| 110x 80 | T0130011 |    |    | 930 €   |       | 1 | 3 | 37.5 | 0.20 |
| 120x 80 | T0130012 | M1 | M1 | 990 €   |       | 1 | 3 | 38   | 0.20 |
| 140x 90 | T0130014 |    |    | 1.150 € |       | 1 | 3 | 43.5 | 0.25 |
| 160x 90 | T0130016 |    |    | 1.290 € |       | 1 | 3 | 45   | 0.30 |
| 180x 90 | T0130018 |    |    | 1.490 € |       | 1 | 3 | 52   | 0.34 |

### Badù Veneer

Top 19 mm. thk

|         |          |    |    | LI1     | LI2     |       |   |   |      |      |
|---------|----------|----|----|---------|---------|-------|---|---|------|------|
| 100x 70 | T0130010 |    |    | 980 €   | 1.190 € | FM-M2 | 1 | 3 | 33.5 | 0.16 |
| 110x 80 | T0130011 |    |    | 1.280 € | 1.540 € |       | 1 | 3 | 37.5 | 0.20 |
| 120x 80 | T0130012 | M1 | M1 | 1.450 € | 1.590 € |       | 1 | 3 | 39   | 0.20 |
| 140x 90 | T0130014 |    |    | 1.620 € | 1.780 € |       | 1 | 3 | 43.5 | 0.25 |
| 160x 90 | T0130016 |    |    | 1.870 € | 2.130 € |       | 1 | 3 | 45   | 0.30 |
| 180x 90 | T0130018 |    |    | 2.060 € | 2.390 € |       | 1 | 3 | 52   | 0.34 |

### Badù HPL

Top 10 mm. thk

|         |          |    |    | HH1     | HH2     | HH3     |       |   |   |      |      |
|---------|----------|----|----|---------|---------|---------|-------|---|---|------|------|
| 100x 70 | T0130010 |    |    | 1.030 € | 1.090 € | 1.290 € | FM-M2 | 1 | 3 | 33.5 | 0.16 |
| 110x 80 | T0130011 |    |    | 1.250 € | 1.310 € | 1.510 € |       | 1 | 3 | 37.5 | 0.20 |
| 120x 80 | T0130012 | M1 | M1 | 1.270 € | 1.340 € | 1.630 € |       | 1 | 3 | 39   | 0.20 |
| 140x 90 | T0130014 |    |    | 1.330 € | 1.410 € | 1.750 € |       | 1 | 3 | 43.5 | 0.25 |
| 160x 90 | T0130016 |    |    | 1.680 € | 1.830 € | 2.030 € |       | 1 | 3 | 45   | 0.30 |
| 180x 90 | T0130018 |    |    | 1.860 € | 2.010 € | 2.190 € |       | 1 | 3 | 52   | 0.34 |

**Badù Glass**

Top 10 mm. thk

|         |          |    |    | GVB     | GVC     | GVD     |       |   |   |       |      |
|---------|----------|----|----|---------|---------|---------|-------|---|---|-------|------|
| 100x 70 | T0130010 |    |    | 690 €   | 740 €   | 786 €   |       | 1 | 3 | 50.35 | 0.16 |
| 110x 80 | T0130011 |    |    | 890 €   | 950 €   | 995 €   |       | 1 | 3 | 57.5  | 0.20 |
| 120x 80 | T0130012 | MI | MI | 950 €   | 1.100 € | 1.170 € | FM-M2 | 1 | 3 | 58.9  | 0.20 |
| 140x 90 | T0130014 |    |    | 1.120 € | 1.260 € | 1.380 € |       | 1 | 3 | 68    | 0.25 |
| 160x 90 | T0130016 |    |    | 1.290 € | 1.450 € | 1.620 € |       | 1 | 3 | 76.7  | 0.30 |
| 180x 90 | T0130018 |    |    | 1.460 € | 1.570 € | 1.830 € |       | 1 | 3 | 81.5  | 0.34 |

**Badù Ceramic**

Top 14 mm. thk

|         |          |    |    | GKA     | GKB     | GMA     |       |   |   |      |      |
|---------|----------|----|----|---------|---------|---------|-------|---|---|------|------|
| 100x 70 | T0130010 |    |    | 890 €   | 960 €   | 1.180 € |       | 1 | 3 | 57.4 | 0.16 |
| 110x 80 | T0130011 |    |    | 1.150 € | 1.230 € | 1.390 € |       | 1 | 3 | 65.5 | 0.21 |
| 120x 80 | T0130012 | MI | MI | 1.250 € | 1.320 € | 1.530 € | FM-M2 | 1 | 3 | 67.9 | 0.21 |
| 140x 90 | T0130014 |    |    | 1.520 € | 1.590 € | 1.790 € |       | 1 | 3 | 79.4 | 0.24 |
| 160x 90 | T0130016 |    |    | 1.720 € | 1.790 € | 1.960 € |       | 1 | 3 | 89.7 | 0.25 |
| 180x 90 | T0130018 |    |    | 1.880 € | 1.950 € | 2.290 € |       | 1 | 3 | 96.5 | 0.29 |

| Version | Code | Legs | Frame | Top and extensions | Optional | Q.ty | boxes | Kg | M <sup>3</sup> |
|---------|------|------|-------|--------------------|----------|------|-------|----|----------------|
|---------|------|------|-------|--------------------|----------|------|-------|----|----------------|

**Badù Melamine HL**

Top and extensions 18 mm. thk - 120/170 x 80 CATAS certificated

|                        |          |    |         | HLI |         |       |      |   |      |      |
|------------------------|----------|----|---------|-----|---------|-------|------|---|------|------|
| 100/140 x70            | T0130101 |    |         |     | 736 €   |       | 1    | 4 | 38   | 0.16 |
| 120/170 x80            | T0130121 |    |         |     | 820 €   |       | 1    | 4 | 44   | 0.23 |
| 140/200 x90            | T0130139 |    |         |     | 856 €   |       | 1    | 4 | 51   | 0.30 |
| 140/190/240x 90        | T0130141 |    |         |     | 1.190 € |       | 1    | 5 | 59.5 | 0.31 |
| 160/220x 90            | T0130160 |    |         |     | 1.210 € |       | 1    | 4 | 53   | 0.34 |
| 160/210/260x 90        | T0130161 | MI | MI      |     | 1.540 € | FM-M2 | 1    | 5 | 61   | 0.36 |
| 180/240x 90            | T0130180 |    |         |     | 1.390 € |       | 1    | 4 | 60   | 0.38 |
| 180/230/280x 90        | T0130181 |    |         |     | 1.580 € |       | 1    | 5 | 67.5 | 0.40 |
| XL 110/155/200/245 x80 | T0137111 |    |         |     | 1.181 € |       | 1    | 5 | 55   | 0.28 |
| XL 140/190/240/290 x90 | T0137141 |    |         |     | 1.576 € |       | 1    | 6 | 70   | 0.40 |
| XL 160/210/260/310 x90 | T0137161 |    | 1.650 € | 1   | 6       | 75    | 0.50 |   |      |      |

**Badù MDF**

Top and extensions 19 mm. thk

|                        |          |    |         | LM1 |         |       |      |   |      |      |
|------------------------|----------|----|---------|-----|---------|-------|------|---|------|------|
| 100/140x 70            | T0130101 |    |         |     | 932 €   |       | 1    | 4 | 38   | 0.16 |
| 120/170x 80            | T0130121 |    |         |     | 1.070 € |       | 1    | 4 | 44   | 0.23 |
| 140/200 x90            | T0130139 |    |         |     | 1.351 € |       | 1    | 4 | 51   | 0.30 |
| 140/190/240x 90        | T0130141 |    |         |     | 1.590 € |       | 1    | 5 | 59.5 | 0.31 |
| 160/220x 90            | T0130160 |    |         |     | 1.650 € |       | 1    | 4 | 53   | 0.34 |
| 160/210/260x 90        | T0130161 | MI | MI      |     | 1.945 € | FM-M2 | 1    | 5 | 61   | 0.36 |
| 180/240x 90            | T0130180 |    |         |     | 1.950 € |       | 1    | 4 | 60   | 0.38 |
| 180/230/280x 90        | T0130181 |    |         |     | 2.130 € |       | 1    | 5 | 67.5 | 0.40 |
| XL 110/155/200/245x 80 | T0137111 |    |         |     | 1.430 € |       | 1    | 5 | 55   | 0.28 |
| XL 140/190/240/290 x90 | T0137141 |    |         |     | 1.875 € |       | 1    | 6 | 70   | 0.40 |
| XL 160/210/260/310 x90 | T0137161 |    | 2.088 € | 1   | 6       | 75    | 0.50 |   |      |      |

**Badü Veneer**

Top and extensions 19 mm. thk

|                        |          |    |    | L11     | L12     |       |   |   |      |      |
|------------------------|----------|----|----|---------|---------|-------|---|---|------|------|
| 100/140x 70            | TO130101 |    |    | 1.510 € | 1.895 € |       | 1 | 4 | 38   | 0.16 |
| 120/170x 80            | TO130121 |    |    | 1.680 € | 1.990 € |       | 1 | 4 | 44   | 0.23 |
| 140/200 x90            | TO130139 |    |    | 1.990 € | 2.390 € |       | 1 | 4 | 51   | 0.30 |
| 140/190/240x 90        | TO130141 |    |    | 2.390 € | 2.790 € |       | 1 | 5 | 59.5 | 0.31 |
| 160/220x 90            | TO130160 |    |    | 2.180 € | 2.590 € |       | 1 | 4 | 53   | 0.34 |
| 160/210/260x 90        | TO130161 | M1 | M1 | 2.470 € | 2.890 € | FM-M2 | 1 | 5 | 61   | 0.36 |
| 180/240x 90            | TO130180 |    |    | 2.590 € | 2.870 € |       | 1 | 4 | 60   | 0.38 |
| 180/230/280x 90        | TO130181 |    |    | 2.980 € | 3.250 € |       | 1 | 5 | 67.5 | 0.40 |
| XL 110/155/200/245x 80 | TO137111 |    |    | 2.370 € | 2.780 € |       | 1 | 5 | 55   | 0.28 |
| XL 140/190/240/290 x90 | TO137141 |    |    | 2.570 € | 2.990 € |       | 1 | 6 | 70   | 0.40 |
| XL 160/210/260/310 x90 | TO137161 |    |    | 2.670 € | 2.950 € |       | 1 | 6 | 75   | 0.50 |

**Badü HPL**

Top and extensions 10 mm. thk

|                        |          |    |    | HH1     | HH2     | HH3     |       |   |   |      |      |
|------------------------|----------|----|----|---------|---------|---------|-------|---|---|------|------|
| 100/140x 70            | TO130101 |    |    | 1.338 € | 1.360 € | 1.590 € |       | 1 | 4 | 38   | 0.16 |
| 120/170x 80            | TO130121 |    |    | 1.620 € | 1.650 € | 1.850 € |       | 1 | 4 | 44   | 0.23 |
| 140/200 x90            | TO130139 |    |    | 1.860 € | 1.890 € | 2.110 € |       | 1 | 4 | 51   | 0.30 |
| 140/190/240x 90        | TO130141 |    |    | 2.130 € | 2.170 € | 2.480 € |       | 1 | 5 | 59.5 | 0.31 |
| 160/220x 90            | TO130160 |    |    | 2.180 € | 2.220 € | 2.390 € |       | 1 | 4 | 53   | 0.34 |
| 160/210/260x 90        | TO130161 | M1 | M1 | 2.410 € | 2.480 € | 2.810 € | FM-M2 | 1 | 5 | 61   | 0.36 |
| 180/240x 90            | TO130180 |    |    | 2.280 € | 2.340 € | 2.695 € |       | 1 | 4 | 60   | 0.38 |
| 180/230/280x 90        | TO130181 |    |    | 2.490 € | 2.550 € | 2.990 € |       | 1 | 5 | 67.5 | 0.40 |
| XL 110/155/200/245x 80 | TO137111 |    |    | 2.560 € | 2.590 € | 2.790 € |       | 1 | 5 | 55   | 0.28 |
| XL 140/190/240/290 x90 | TO137141 |    |    | 2.310 € | 2.350 € | 2.880 € |       | 1 | 6 | 70   | 0.40 |
| XL 160/210/260/310 x90 | TO137161 |    |    | 2.650 € | 2.710 € | 3.190 € |       | 1 | 6 | 75   | 0.50 |

**Badü Glass**

Glass top 10 mm. thk MDF extensions 19 mm. thk

|                        |          |    |    | GVB     | GVC     | GVD     |       |   |   |      |      |
|------------------------|----------|----|----|---------|---------|---------|-------|---|---|------|------|
| 100/140 x70            | TO130101 |    |    | 958 €   | 1.064 € | 1.125 € |       | 1 | 4 | 47   | 0.16 |
| 120/170 x80            | TO130121 |    |    | 1.071 € | 1.222 € | 1.294 € |       | 1 | 4 | 56   | 0.23 |
| 140/200 x90            | TO130139 |    |    | 1.181 € | 1.279 € | 1.357 € |       | 1 | 4 | 63   | 0.30 |
| 140/190/240x 90        | TO130141 |    |    | 1.770 € | 1.860 € | 1.940 € |       | 1 | 5 | 83   | 0.31 |
| 160/220x 90            | TO130160 |    |    | 1.690 € | 1.790 € | 1.940 € |       | 1 | 4 | 85   | 0.34 |
| 160/210/260x 90        | TO130161 | M1 | M1 | 1.985 € | 2.010 € | 2.160 € | FM-M2 | 1 | 5 | 93   | 0.36 |
| 180/240x 90            | TO130180 |    |    | 1.740 € | 1.830 € | 2.030 € |       | 1 | 4 | 89.5 | 0.38 |
| 180/230/280x 90        | TO130181 |    |    | 1.850 € | 1.950 € | 2.150 € |       | 1 | 5 | 97.5 | 0.40 |
| XL 110/155/200/245 x80 | TO137111 |    |    | 1.482 € | 1.605 € | 1.776 € |       | 1 | 5 | 67   | 0.28 |
| XL 140/190/240/290 x90 | TO137141 |    |    | 2.132 € | 2.313 € | 2.537 € |       | 1 | 6 | 85   | 0.40 |
| XL 160/210/260/310 x90 | TO137161 |    |    | 2.270 € | 2.443 € | 2.706 € |       | 1 | 6 | 90   | 0.50 |

**Badù Ceramic**

Ceramic top 14 mm. thk MDF extensions 22 mm. thk

|                        |          |    |    | GKA     | GKB     | GMA     |       |   |    |       |      |
|------------------------|----------|----|----|---------|---------|---------|-------|---|----|-------|------|
| 100/140 x70            | T0130101 |    |    | 1.360 € | 1.436 € | 1.579 € |       | 1 | 4  | 50    | 0.16 |
| 120/170 x80            | T0130121 |    |    | 1.490 € | 1.589 € | 1.744 € |       | 1 | 4  | 60    | 0.23 |
| 140/200 x90            | T0130139 |    |    | 1.660 € | 1.771 € | 1.942 € |       | 1 | 4  | 68    | 0.30 |
| 140/190/240x 90        | T0130141 |    |    | 2.090 € | 2.170 € | 2.550 € |       | 1 | -- | 95.4  | 0.31 |
| 160/220x 90            | T0130160 |    |    | 2.080 € | 2.130 € | 2.630 € |       | 1 | -- | 97.7  | 0.34 |
| 160/210/260x 90        | T0130161 | MI | MI | 2.190 € | 2.285 € | 2.795 € | FM-M2 | 1 | -- | 105.7 | 0.36 |
| 180/240x 90            | T0130180 |    |    | 2.110 € | 2.160 € | 2.650 € |       | 1 | -- | 104.5 | 0.38 |
| 180/230/280x 90        | T0130181 |    |    | 2.220 € | 2.280 € | 2.770 € |       | 1 | -- | 112.5 | 0.40 |
| XL 110/155/200/245 x80 | T0137111 |    |    | 1.936 € | 2.078 € | 2.185 € |       | 1 | 5  | 70    | 0.28 |
| XL 140/190/240/290 x90 | T0137141 |    |    | 2.634 € | 2.858 € | 3.142 € |       | 1 | 6  | 90    | 0.40 |
| XL 160/210/260/310 x90 | T0137161 |    |    | 2.856 € | 2.958 € | 3.233 € |       | 1 | 6  | 95    | 0.50 |

**Badù Ceramic + extensions HPL**

Ceramic top 14 mm. thk HPL extensions

|                        |          |    |    | GKA     | GKB     | GMA     |       |   |    |       |      |
|------------------------|----------|----|----|---------|---------|---------|-------|---|----|-------|------|
| 100/140 x70            | T0138100 |    |    | 1.540 € | 1.616 € | 1.759 € |       | 1 | -- | 50    | 0.16 |
| 120/170 x80            | T0138120 |    |    | 1.680 € | 1.779 € | 1.934 € |       | 1 | -- | 60    | 0.23 |
| 140/200 x90            | T0138140 |    |    | 1.850 € | 1.961 € | 2.132 € |       | 1 | -- | 68    | 0.30 |
| 140/190/240x 90        | T0138141 |    |    | 2.480 € | 2.560 € | 2.880 € |       | 1 | -- | 95.4  | 0.31 |
| 160/220x 90            | T0138160 |    |    | 2.370 € | 2.420 € | 2.820 € |       | 1 | -- | 97.7  | 0.34 |
| 160/210/260x 90        | T0138161 | MI | MI | 2.940 € | 3.038 € | 3.285 € | FM-M2 | 1 | -- | 105.7 | 0.36 |
| 180/240x 90            | T0138180 |    |    | 2.580 € | 2.680 € | 2.970 € |       | 1 | -- | 104.5 | 0.38 |
| 180/230/280x 90        | T0138181 |    |    | 3.180 € | 3.270 € | 3.560 € |       | 1 | -- | 112.5 | 0.40 |
| XL 110/155/200/245 x80 | T0139110 |    |    | 2.170 € | 2.280 € | 2.470 € |       | 1 | -- | 70    | 0.28 |
| XL 140/190/240/290 x90 | T0139140 |    |    | 3.130 € | 3.280 € | 3.500 € |       | 1 | -- | 90    | 0.40 |
| XL 160/210/260/310 x90 | T0139160 |    |    | 3.340 € | 3.448 € | 3.720 € |       | 1 | -- | 95    | 0.50 |

**Note:**

For Glass or Crystal Ceramic tops, extensions Only in MDF or HPL - Table 180x100 NO Ceramic K26

**Frame finishes****Metal**

|           |   |
|-----------|---|
| <b>MI</b> | WHITE <b>BB</b> , BROWN <b>E6</b> , SAND <b>EC</b> , WHITE PEARL <b>EF</b> , GRAPHITE <b>EG</b> , BLACK <b>EN</b> |
|-----------|---|

**Top and extensions finishes****Melamine**

|            |  |
|------------|--|
| <b>HLI</b> | WHITE <b>M01</b> , GRAFITE <b>M02</b> , BLACK <b>M04</b> , SAND <b>M07</b> |
|------------|--|

**Veneer**

|            |  |
|------------|--|
| <b>LI1</b> | Stained BLACK <b>I04</b> , Stained WHITE <b>I05</b> , Stained CHERRY RED <b>I09</b> , Stained DARK BROWN <b>I26</b> , Stained NATURAL <b>I40</b> , Stained NATURAL OAK <b>I52</b> , Stained WHITENED <b>I60</b> , Stained DESERT <b>I61</b> , Stained LIGHT GREY <b>I62</b> , Stained DARK GREY <b>I63</b> |
| <b>LI2</b> | NATURAL OAK <b>I22</b> , FLAMED WALNUT <b>I24</b>  |

**Legs finishes****Metal**

|           |   |
|-----------|---|
| <b>MI</b> | WHITE <b>BB</b> , BROWN <b>E6</b> , SAND <b>EC</b> , WHITE PEARL <b>EF</b> , GRAPHITE <b>EG</b> , BLACK <b>EN</b> |
|-----------|---|

**Lacquered MDF**

|            |   |
|------------|---|
| <b>LMI</b> | GRAPHITE GREY <b>G02</b> , BLACK <b>G04</b> , WHITE <b>G05</b> , SAND <b>G07</b> , BROWN <b>G41</b> |
|------------|---|

**HPL**

|            |  |
|------------|--|
| <b>HH1</b> | WHITE/Black Core <b>HB4</b> , BLACK/Black Core <b>HN4</b>  |
| <b>HH2</b> | CEMENT/Black Core <b>HC6</b> , CORTEN/Brown Core <b>HC7</b> , DARK GREY/Black Core <b>HGW</b>  |
| <b>HH3</b> | ST WHITE/White Core <b>AB4</b> , ST SAND/Sand Core <b>ACR</b> , ST GRAPHITE GREY/ Grafite Core <b>AGD</b> , ST BLACK/Black Core <b>AN4</b> , ST TORTORA/Tortora Core <b>ATR</b> , ST RED NAMIB/Red Core <b>FAM</b> , ST YELLOW EVORA/Yellow Core <b>FGO</b> , ST RED BULGARO/Red Core <b>FRB</b> , ST GREEN KITAMI/Green Core <b>FVK</b> |

**Top finishes****Glass**

|            |   |
|------------|---|
| <b>GVC</b> | MATT GRAFITE ANTISCRATCH <b>J31</b> , MATT SAND ANTISCRATCH <b>J32</b>  |
| <b>GVD</b> | EXTRA CLEAR MATT WHITE ANTISCRATCH <b>J41</b>   |
| <b>GVB</b> | EXTRA CLEAR GLOSSY WHITE <b>J21</b> , EXTRA CLEAR GLOSSY CHERRY RED <b>J25</b> , EXTRA CLEAR GLOSSY BLUE SAPPHIRE <b>J26</b> , EXTRA CLEAR GLOSSY BLUE TURQUOISE <b>J27</b> |

**Crystal Ceramic and Ceramic**

|            |   |
|------------|---|
| <b>GMA</b> | MARBLE CALACATTA GLOSSY WHITE <b>K32</b> , BLACK GREEK MARBLE <b>K33</b> , MARBLE GLOSSY NOIR DESIR <b>K35</b> , MARBLE CALACATTA MATT WHITE <b>K42</b> , MARBLE MATT NOIR DESIR <b>K45</b> , MARBLE MATT GREEN TINOS <b>K46</b> , MARBLE STATUARIO WHITE MATT <b>K47</b> , MARBLE CALACAT BLACK Bush Hammered <b>K50</b> |
|------------|---|

**Crystal Ceramic and Ceramic**

|            |  |
|------------|--|
| <b>GKA</b> | CHARCOAL SAVOIA <b>K11</b> , CEMENT SAVOIA <b>K12</b>  |
| <b>GKB</b> | WHITE CALCE <b>K24</b> , BLACK CALCE <b>K25</b> , TORTORA CALCE <b>K26</b> , PIASENTINA STONE TAUPE Materica <b>K55</b> , TERRACOTTA Matt <b>K90</b> , MATT GREEN <b>K91</b> |

**Optionals:**

|              |                      | Value   | Options/notes  |
|--------------|----------------------|---------|--|
| <b>FM-M2</b> | Indoor matt metal M2 | + 180 € | ASH GREY <b>ES</b> , BLUE SAPPHIRE <b>EE</b> , BLUE TURQUOISE <b>EH</b> , BRONZE <b>E2</b> , BULGARO RED <b>FP</b> , CHERRY RED <b>EQ</b> , DARK GREEN <b>EL</b> , FACEPOWDER PINK <b>E8</b> , FANGO <b>E3</b> , GOLDEN YELLOW <b>EO</b> , LIGHT BLUE <b>EO</b> , LIGHT GREY <b>ET</b> , OCEAN BLUE <b>E1</b> , OCHER YELLOW <b>E7</b> , PAPAYA ORANGE <b>EA</b> , PASTEL YELLOW <b>E4</b> , PINE GREEN <b>EJ</b> , RED <b>ER</b> , SAGE GREEN <b>E9</b> |

**100x 70**

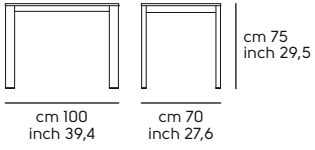

**110x 80**

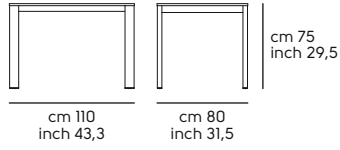

**120x 80**

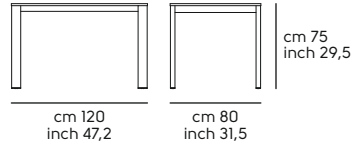

**140x 90**

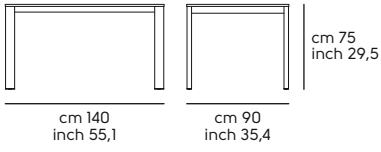

**160x 90**

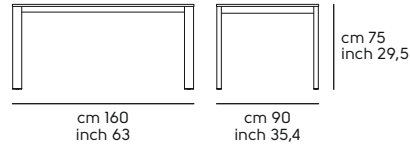

**180x 90**

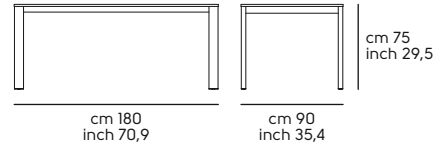

**100/140x 70**

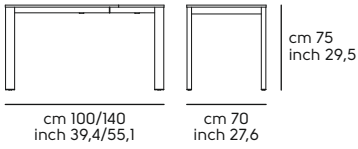

**120/170x 80**

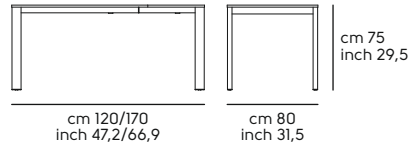

**140/200x 90**

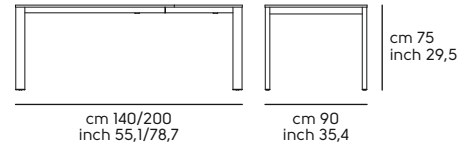

**140/190/240x 90**

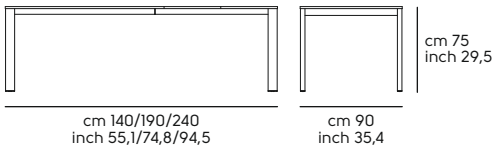

**160/220x 90**

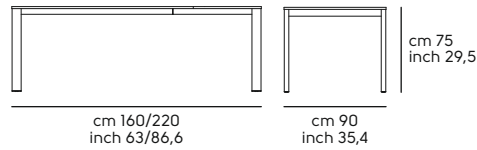

**160/210/260x 90**

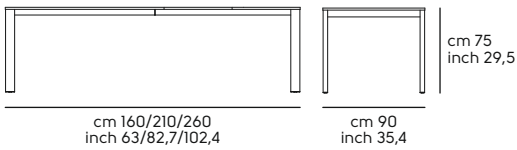

**180/240x 90**

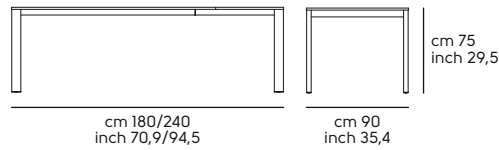

**180/230/280x 90**

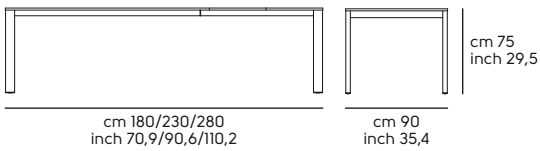

**XL 110/155/200/245 x80**

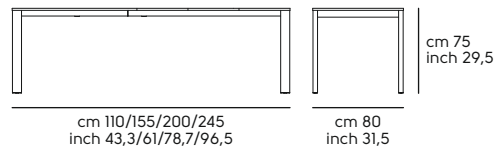

**XL 140/190/240/290 x90**

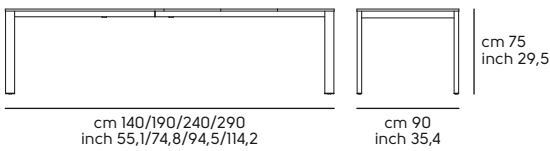

**XL 160/210/260/310 x90**

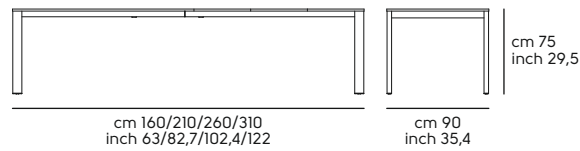

# Blade design Paolo Vernier

## Table Blade

Frame in: metal. Legs: covered with solid ash



| Version | Code | Legs | Frame | Top | Optional | Q.ty | boxes | Kg | M <sup>2</sup> |
|---------|------|------|-------|-----|----------|------|-------|----|----------------|
|---------|------|------|-------|-----|----------|------|-------|----|----------------|

### Blade Melamine HL

Top 18 mm. thk

|         |          |     |    | HL1     |       |   |   |      |      |
|---------|----------|-----|----|---------|-------|---|---|------|------|
| 100x 70 | T1800010 |     |    | 840 €   |       | 1 | 3 | 33.4 | 0.16 |
| 110x 80 | T1800011 |     |    | 940 €   |       | 1 | 3 | 36.5 | 0.20 |
| 120x 80 | T1800012 |     |    | 975 €   |       | 1 | 3 | 38   | 0.21 |
| 140x 90 | T1800014 | LFI | MI | 1.060 € | FM-M2 | 1 | 3 | 43.4 | 0.26 |
| 160x 90 | T1800016 |     |    | 1.180 € |       | 1 | 3 | 44.7 | 0.28 |
| 180x 90 | T1800018 |     |    | 1.300 € |       | 1 | 3 | 51.5 | 0.34 |
| 180x100 | T1800019 |     |    | 1.420 € |       | 1 | 3 | 58   | 0.35 |

### Blade MDF

Top 19 mm. thk

|         |          |     |    | LMI     |       |   |   |      |      |
|---------|----------|-----|----|---------|-------|---|---|------|------|
| 100x 70 | T1800010 |     |    | 1.040 € |       | 1 | 3 | 33.4 | 0.16 |
| 110x 80 | T1800011 |     |    | 1.280 € |       | 1 | 3 | 36.5 | 0.20 |
| 120x 80 | T1800012 |     |    | 1.340 € |       | 1 | 3 | 38   | 0.21 |
| 140x 90 | T1800014 | LFI | MI | 1.500 € | FM-M2 | 1 | 3 | 43.4 | 0.26 |
| 160x 90 | T1800016 |     |    | 1.640 € |       | 1 | 3 | 44.7 | 0.28 |
| 180x 90 | T1800018 |     |    | 1.840 € |       | 1 | 3 | 51.5 | 0.34 |
| 180x100 | T1800019 |     |    | 1.960 € |       | 1 | 3 | 58   | 0.35 |

### Blade Veneer

Top and extensions 19 mm. thk | ATTENTION ! legs F24 and Top + extensions I24 are in different wood essences

|         |          |     |    | L11     | L12     |       |   |   |      |      |
|---------|----------|-----|----|---------|---------|-------|---|---|------|------|
| 100x 70 | T1800010 |     |    | 1.330 € | 1.540 € |       | 1 | 3 | 33.4 | 0.16 |
| 110x 80 | T1800011 |     |    | 1.630 € | 1.890 € |       | 1 | 3 | 36.5 | 0.20 |
| 120x 80 | T1800012 |     |    | 1.800 € | 1.940 € |       | 1 | 3 | 38   | 0.21 |
| 140x 90 | T1800014 | LFI | MI | 1.970 € | 2.130 € | FM-M2 | 1 | 3 | 43.4 | 0.26 |
| 160x 90 | T1800016 |     |    | 2.220 € | 2.480 € |       | 1 | 3 | 44.7 | 0.28 |
| 180x 90 | T1800018 |     |    | 2.410 € | 2.740 € |       | 1 | 3 | 51.5 | 0.34 |
| 180x100 | T1800019 |     |    | 2.530 € | 2.860 € |       | 1 | 3 | 58   | 0.35 |

### Blade HPL

Top 10 mm. thk

|         |          |     |    | HH1     | HH2     | HH3     |       |   |   |      |      |
|---------|----------|-----|----|---------|---------|---------|-------|---|---|------|------|
| 100x 70 | T1800010 |     |    | 1.380 € | 1.440 € | 1.640 € |       | 1 | 3 | 33.4 | 0.16 |
| 110x 80 | T1800011 |     |    | 1.600 € | 1.660 € | 1.860 € |       | 1 | 3 | 36.5 | 0.20 |
| 120x 80 | T1800012 |     |    | 1.620 € | 1.690 € | 1.980 € |       | 1 | 3 | 38   | 0.21 |
| 140x 90 | T1800014 | LFI | MI | 1.680 € | 1.760 € | 2.100 € | FM-M2 | 1 | 3 | 43.4 | 0.26 |
| 160x 90 | T1800016 |     |    | 2.030 € | 2.180 € | 2.380 € |       | 1 | 3 | 44.7 | 0.28 |
| 180x 90 | T1800018 |     |    | 2.210 € | 2.360 € | 2.540 € |       | 1 | 3 | 51.5 | 0.34 |
| 180x100 | T1800019 |     |    | 2.330 € | 2.480 € | 2.660 € | FM-M2 | 1 | 3 | 58   | 0.35 |

**Blade Glass**

Top 10 mm. thk

|         |          |     |    | GVB     | GVC     | GVD     |       |   |   |       |      |
|---------|----------|-----|----|---------|---------|---------|-------|---|---|-------|------|
| 100x 70 | T1800010 |     |    | 1.040 € | 1.090 € | 1.136 € |       | 1 | 3 | 50.35 | 0.16 |
| 110x 80 | T1800011 |     |    | 1.240 € | 1.300 € | 1.358 € |       | 1 | 3 | 56.5  | 0.20 |
| 120x 80 | T1800012 |     |    | 1.300 € | 1.450 € | 1.520 € |       | 1 | 3 | 58.9  | 0.21 |
| 140x 90 | T1800014 | LFI | MI | 1.470 € | 1.610 € | 1.730 € | FM-M2 | 1 | 3 | 68    | 0.26 |
| 160x 90 | T1800016 |     |    | 1.640 € | 1.800 € | 1.970 € |       | 1 | 3 | 76.7  | 0.28 |
| 180x 90 | T1800018 |     |    | 1.810 € | 1.920 € | 2.180 € |       | 1 | 3 | 81.5  | 0.34 |
| 180x100 | T1800019 |     |    | 1.930 € | 2.040 € | 2.340 € |       | 1 | 3 | 93    | 0.35 |

**Blade Ceramic**

Top 14 mm. thk

|         |          |     |    | GKA     | GKB     | GMA     |       |   |   |      |      |
|---------|----------|-----|----|---------|---------|---------|-------|---|---|------|------|
| 100x 70 | T1800010 |     |    | 1.240 € | 1.310 € | 1.530 € |       | 1 | 3 | 57.4 | 0.16 |
| 110x 80 | T1800011 |     |    | 1.500 € | 1.580 € | 1.740 € |       | 1 | 3 | 64.5 | 0.20 |
| 120x 80 | T1800012 |     |    | 1.600 € | 1.670 € | 1.880 € |       | 1 | 3 | 68   | 0.21 |
| 140x 90 | T1800014 | LFI | MI | 1.870 € | 1.940 € | 2.140 € | FM-M2 | 1 | 3 | 79.4 | 0.26 |
| 160x 90 | T1800016 |     |    | 2.070 € | 2.140 € | 2.310 € |       | 1 | 3 | 89.7 | 0.28 |
| 180x 90 | T1800018 |     |    | 2.230 € | 2.300 € | 2.640 € |       | 1 | 3 | 96.5 | 0.34 |
| 180x100 | T1800019 |     |    | 2.350 € | 2.420 € | 2.760 € |       | 1 | 3 | 109  | 0.35 |

| Version | Code | Legs | Frame | Top and extensions |  |  | Optional |  |  |  |  |
|---------|------|------|-------|--------------------|--|--|----------|---|---|---|---|
|---------|------|------|-------|--------------------|--|--|----------|---|---|---|---|

**Blade Melamine HL**

Top and extensions 18 mm. thk

|                        |          |     |    | HLI |         |  |       |   |   |      |      |
|------------------------|----------|-----|----|-----|---------|--|-------|---|---|------|------|
| 100/140 x70            | T1801101 |     |    |     | 1.086 € |  |       | 1 | 4 | 50   | 0.21 |
| 120/170 x80            | T1801121 |     |    |     | 1.170 € |  |       | 1 | 4 | 50   | 0.23 |
| 140/200 x90            | T1801139 |     |    |     | 1.207 € |  |       | 1 | 4 | 55   | 0.27 |
| 140/190/240 x90        | T1801141 |     |    |     | 1.301 € |  |       | 1 | 5 | 59.4 | 0.32 |
| 160/220 x90            | T1801160 |     |    |     | 1.560 € |  |       | 1 | 4 | 52.7 | 0.32 |
| 160/210/260 x90        | T1801161 |     |    |     | 1.890 € |  |       | 1 | 5 | 60.7 | 0.34 |
| 180/240 x90            | T1801180 | LFI | MI |     | 1.740 € |  | FM-M2 | 1 | 4 | 59.5 | 0.38 |
| 180/230/280 x90        | T1801181 |     |    |     | 1.930 € |  |       | 1 | 5 | 67.5 | 0.40 |
| 180/240x100            | T1801190 |     |    |     | 1.850 € |  |       | 1 | 4 | 66   | 0.40 |
| 180/230/280x100        | T1801191 |     |    |     | 2.040 € |  |       | 1 | 5 | 74   | 0.43 |
| XL 110/155/200/245 x80 | T1803111 |     |    |     | 1.531 € |  |       | 1 | 6 | 59   | 0.52 |
| XL 140/190/240/290 x90 | T1803141 |     |    |     | 1.513 € |  |       | 1 | 6 | 71   | 0.52 |
| XL 160/210/260/310 x90 | T1803161 |     |    |     | 2.031 € |  |       | 1 | 6 | 72   | 0.52 |

**Blade MDF**

Top and extensions 19 mm. thk

|                        |          |     |    | LMI |         |  |       |   |   |      |      |
|------------------------|----------|-----|----|-----|---------|--|-------|---|---|------|------|
| 100/140 x70            | T1801101 |     |    |     | 1.282 € |  |       | 1 | 4 | 50   | 0.21 |
| 120/170 x80            | T1801121 |     |    |     | 1.420 € |  |       | 1 | 4 | 50   | 0.23 |
| 140/200 x90            | T1801139 |     |    |     | 1.676 € |  |       | 1 | 4 | 55   | 0.27 |
| 140/190/240 x90        | T1801141 |     |    |     | 1.940 € |  |       | 1 | 5 | 59.4 | 0.32 |
| 160/220 x90            | T1801160 |     |    |     | 2.000 € |  | FM-M2 | 1 | 4 | 52.7 | 0.32 |
| 160/210/260 x90        | T1801161 |     |    |     | 2.295 € |  |       | 1 | 5 | 60.7 | 0.34 |
| 180/240 x90            | T1801180 | LFI | MI |     | 2.300 € |  |       | 1 | 4 | 59.5 | 0.38 |
| 180/230/280 x90        | T1801181 |     |    |     | 2.480 € |  |       | 1 | 5 | 67.5 | 0.40 |
| 180/240x100            | T1801190 |     |    |     | 2.410 € |  |       | 1 | 4 | 66   | 0.40 |
| 180/230/280x100        | T1801191 |     |    |     | 2.590 € |  |       | 1 | 5 | 74   | 0.43 |
| XL 110/155/200/245 x80 | T1803111 |     |    |     | 1.780 € |  |       | 1 | 6 | 59   | 0.52 |
| XL 140/190/240/290 x90 | T1803141 |     |    |     | 2.191 € |  | FM-M2 | 1 | 6 | 71   | 0.52 |
| XL 160/210/260/310 x90 | T1803161 |     |    |     | 2.316 € |  |       | 1 | 6 | 72   | 0.52 |

**Blade Veneer**

Top and extensions 19 mm. thk | ATTENTION !: legs F24 and Top + extensions I24 are in different wood essences

|                        |          |     |    | L11     | L12     |       |   |   |      |      |
|------------------------|----------|-----|----|---------|---------|-------|---|---|------|------|
| 100/140 x70            | T1801101 |     |    | 1.860 € | 2.245 € |       | 1 | 4 | 50   | 0.21 |
| 120/170 x80            | T1801121 |     |    | 2.030 € | 2.340 € |       | 1 | 4 | 50   | 0.23 |
| 140/200 x90            | T1801139 |     |    | 2.340 € | 2.740 € |       | 1 | 4 | 55   | 0.27 |
| 140/190/240 x90        | T1801141 |     |    | 2.740 € | 3.140 € |       | 1 | 5 | 59.4 | 0.32 |
| 160/220 x90            | T1801160 |     |    | 2.530 € | 2.940 € |       | 1 | 4 | 52.7 | 0.32 |
| 160/210/260 x90        | T1801161 |     |    | 2.820 € | 3.240 € |       | 1 | 5 | 60.7 | 0.34 |
| 180/240 x90            | T1801180 | LFI | M1 | 2.940 € | 3.220 € | FM-M2 | 1 | 4 | 59.5 | 0.38 |
| 180/230/280 x90        | T1801181 |     |    | 3.330 € | 3.600 € |       | 1 | 5 | 67.5 | 0.40 |
| 180/240x100            | T1801190 |     |    | 3.050 € | 3.510 € |       | 1 | 4 | 66   | 0.40 |
| 180/230/280x100        | T1801191 |     |    | 3.440 € | 3.910 € |       | 1 | 5 | 74   | 0.43 |
| XL 110/155/200/245 x80 | T1803111 |     |    | 2.720 € | 3.130 € |       | 1 | 6 | 59   | 0.52 |
| XL 140/190/240/290 x90 | T1803141 |     |    | 2.920 € | 3.340 € |       | 1 | 6 | 71   | 0.52 |
| XL 160/210/260/310 x90 | T1803161 |     |    | 3.020 € | 3.250 € |       | 1 | 6 | 72   | 0.52 |

**Blade HPL**

Top and extensions 10 mm. thk

|                        |          |     |    | HH1     | HH2     | HH3     |       |   |   |      |      |
|------------------------|----------|-----|----|---------|---------|---------|-------|---|---|------|------|
| 100/140 x70            | T1801101 |     |    | 1.688 € | 1.710 € | 1.940 € |       | 1 | 4 | 50   | 0.21 |
| 120/170 x80            | T1801121 |     |    | 1.970 € | 2.000 € | 2.200 € |       | 1 | 4 | 50   | 0.23 |
| 140/200 x90            | T1801139 |     |    | 2.210 € | 2.240 € | 2.460 € |       | 1 | 4 | 55   | 0.27 |
| 140/190/240 x90        | T1801141 |     |    | 2.480 € | 2.520 € | 2.830 € |       | 1 | 5 | 59.4 | 0.32 |
| 160/220 x90            | T1801160 |     |    | 2.530 € | 2.570 € | 3.740 € |       | 1 | 4 | 52.7 | 0.32 |
| 160/210/260 x90        | T1801161 |     |    | 2.760 € | 2.830 € | 3.160 € |       | 1 | 5 | 60.7 | 0.34 |
| 180/240 x90            | T1801180 | LFI | M1 | 2.630 € | 2.690 € | 3.045 € | FM-M2 | 1 | 4 | 59.5 | 0.38 |
| 180/230/280 x90        | T1801181 |     |    | 2.840 € | 2.900 € | 3.340 € |       | 1 | 5 | 67.5 | 0.40 |
| 180/240x100            | T1801190 |     |    | 2.740 € | 2.800 € | 3.155 € |       | 1 | 4 | 66   | 0.40 |
| 180/230/280x100        | T1801191 |     |    | 2.950 € | 3.010 € | 3.450 € |       | 1 | 5 | 74   | 0.43 |
| XL 110/155/200/245 x80 | T1803111 |     |    | 2.910 € | 2.940 € | 3.140 € |       | 1 | 6 | 59   | 0.52 |
| XL 140/190/240/290 x90 | T1803141 |     |    | 2.660 € | 2.700 € | 3.230 € |       | 1 | 6 | 71   | 0.52 |
| XL 160/210/260/310 x90 | T1803161 |     |    | 3.000 € | 3.060 € | 3.540 € |       | 1 | 6 | 72   | 0.52 |

**Blade Glass**

Glass top 10 mm. thk MDF extensions 19 mm. thk

|                        |          |     |    | GVB     | GVC     | GVD     |       |   |   |      |      |
|------------------------|----------|-----|----|---------|---------|---------|-------|---|---|------|------|
| 100/140 x70            | T1801101 |     |    | 1.308 € | 1.414 € | 1.475 € |       | 1 | 4 | 55.3 | 0.18 |
| 120/170 x80            | T1801121 |     |    | 1.401 € | 1.554 € | 1.622 € |       | 1 | 4 | 65   | 0.24 |
| 140/200 x90            | T1801139 |     |    | 1.526 € | 1.607 € | 1.682 € |       | 1 | 4 | 76   | 0.30 |
| 140/190/240 x90        | T1801141 |     |    | 1.826 € | 1.984 € | 2.290 € |       | 1 | 5 | 84   | 0.32 |
| 160/220 x90            | T1801160 |     |    | 2.040 € | 2.140 € | 2.290 € |       | 1 | 4 | 84.7 | 0.32 |
| 160/210/260 x90        | T1801161 |     |    | 2.335 € | 2.360 € | 2.510 € |       | 1 | 5 | 92.7 | 0.34 |
| 180/240 x90            | T1801180 | LFI | M1 | 2.090 € | 2.180 € | 2.380 € | FM-M2 | 1 | 4 | 89.5 | 0.38 |
| 180/230/280x 90        | T1801181 |     |    | 2.200 € | 2.300 € | 2.500 € |       | 1 | 5 | 97.5 | 0.40 |
| 180/240x100            | T1801190 |     |    | 2.174 € | 2.267 € | 2.475 € |       | 1 | 4 | 101  | 0.40 |
| 180/230/280x100        | T1801191 |     |    | 2.650 € | 2.830 € | 2.970 € |       | 1 | 5 | 109  | 0.43 |
| XL 110/155/200/245 x80 | T1803111 |     |    | 1.874 € | 1.994 € | 2.164 € |       | 1 | 6 | 74.5 | 0.29 |
| XL 140/190/240/290 x90 | T1803141 |     |    | 2.399 € | 2.614 € | 2.829 € |       | 1 | 6 | 92   | 0.35 |
| XL 160/210/260/310 x90 | T1803161 |     |    | 2.506 € | 1.750 € | 2.983 € |       | 1 | 6 | 100  | 0.37 |

**Blade Ceramic**

Ceramic top 14 mm. thk MDF extensions 22 mm. thk

|                        |          |     |    | GKA     | GKB     | GMA     |       |   |   |       |      |
|------------------------|----------|-----|----|---------|---------|---------|-------|---|---|-------|------|
| 100/140 x70            | T1801101 |     |    | 1.710 € | 1.786 € | 1.929 € |       | 1 | 4 | 62    | 0.18 |
| 120/170 x80            | T1801121 |     |    | 1.808 € | 1.903 € | 2.050 € |       | 1 | 4 | 74    | 0.24 |
| 140/200 x90            | T1801139 |     |    | 1.970 € | 2.077 € | 2.239 € |       | 1 | 4 | 87.4  | 0.30 |
| 140/190/240 x90        | T1801141 |     |    | 2.385 € | 2.506 € | 2.706 € |       | 1 | 5 | 95.4  | 0.32 |
| 160/220 x90            | T1801160 |     |    | 2.430 € | 2.480 € | 2.980 € |       | 1 | 4 | 97.7  | 0.32 |
| 160/210/260 x90        | T1801161 |     |    | 2.540 € | 2.635 € | 3.145 € |       | 1 | 5 | 105.7 | 0.34 |
| 180/240 x90            | T1801180 | LFI | MI | 2.460 € | 2.510 € | 3.000 € | FM-M2 | 1 | 4 | 104.5 | 0.38 |
| 180/230/280x 90        | T1801181 |     |    | 2.570 € | 2.630 € | 3.120 € |       | 1 | 5 | 112.5 | 0.40 |
| 180/240x100            | T1801190 |     |    | 2.558 € | 2.610 € | 3.120 € |       | 1 | 4 | 117   | 0.40 |
| 180/230/280x100        | T1801191 |     |    | 3.250 € | 3.340 € | 3.565 € |       | 1 | 5 | 125   | 0.43 |
| XL 110/155/200/245 x80 | T1803111 |     |    | 2.316 € | 2.466 € | 2.674 € |       | 1 | 6 | 82.5  | 0.29 |
| XL 140/190/240/290 x90 | T1803141 |     |    | 2.920 € | 3.137 € | 3.410 € |       | 1 | 6 | 103   | 0.35 |
| XL 160/210/260/310 x90 | T1803161 |     |    | 3.082 € | 3.181 € | 3.498 € |       | 1 | 6 | 114   | 0.37 |

**Blade Ceramic + extensions HPL**

Ceramic top 14 mm. thk HPL extensions

|                        |          |     |    | GKA     | GKB     | GMA     |       |   |   |       |      |
|------------------------|----------|-----|----|---------|---------|---------|-------|---|---|-------|------|
| 100/140 x70            | T1808100 |     |    | 1.890 € | 1.966 € | 2.109 € |       | 1 | 4 | 62    | 0.18 |
| 120/170 x80            | T1808120 |     |    | 1.998 € | 2.093 € | 2.240 € |       | 1 | 4 | 74    | 0.24 |
| 140/200 x90            | T1808140 |     |    | 2.160 € | 2.267 € | 2.429 € |       | 1 | 4 | 87.4  | 0.30 |
| 140/190/240 x90        | T1808141 |     |    | 2.775 € | 2.896 € | 3.096 € |       | 1 | 5 | 95.4  | 0.32 |
| 160/220 x90            | T1808160 |     |    | 2.720 € | 2.770 € | 3.170 € |       | 1 | 4 | 97.7  | 0.32 |
| 160/210/260 x90        | T1808161 |     |    | 3.290 € | 3.388 € | 3.635 € |       | 1 | 5 | 105.7 | 0.34 |
| 180/240 x90            | T1808180 | LFI | MI | 2.930 € | 3.030 € | 3.320 € | FM-M2 | 1 | 4 | 104.5 | 0.38 |
| 180/230/280x 90        | T1808181 |     |    | 3.530 € | 3.620 € | 3.845 € |       | 1 | 5 | 112.5 | 0.40 |
| 180/240x100            | T1808190 |     |    | 3.060 € | 3.160 € | 3.450 € |       | 1 | 4 | 117   | 0.40 |
| 180/230/280x100        | T1808191 |     |    | 3.670 € | 3.760 € | 3.985 € |       | 1 | 5 | 125   | 0.43 |
| XL 110/155/200/245 x80 | T1809110 |     |    | 2.816 € | 2.956 € | 3.164 € |       | 1 | 6 | 82.5  | 0.29 |
| XL 140/190/240/290 x90 | T1809140 |     |    | 3.510 € | 3.727 € | 4.000 € |       | 1 | 6 | 103   | 0.35 |
| XL 160/210/260/310 x90 | T1809160 |     |    | 3.672 € | 3.771 € | 4.088 € |       | 1 | 6 | 114   | 0.37 |

**Note:**

For Glass or Crystal Ceramic tops, extensions Only in MDF or HPL - Table 180x100 NO Ceramic K26

**Frame finishes**

**Metal**

|           |   |
|-----------|---|
| <b>MI</b> | WHITE <b>BB</b> , BROWN <b>E6</b> , SAND <b>EC</b> , WHITE PEARL <b>EF</b> , GRAPHITE <b>EG</b> , BLACK <b>EN</b> |
|-----------|---|

**Top and extensions finishes**

**Melamine**

|            |  |
|------------|--|
| <b>HLI</b> | WHITE <b>M01</b> , GRAFITE <b>M02</b> , BLACK <b>M04</b> , SAND <b>M07</b> |
|------------|--|

**Lacquered MDF**

|            |   |
|------------|---|
| <b>LMI</b> | GRAPHITE GREY <b>G02</b> , BLACK <b>G04</b> , WHITE <b>G05</b> , SAND <b>G07</b> , BROWN <b>G41</b> |
|------------|---|

**Top and extensions finishes**

**HPL**

|            |  |
|------------|--|
| <b>HH1</b> | WHITE/Black Core <b>HB4</b> , BLACK/Black Core <b>HN4</b>  |
| <b>HH2</b> | CEMENT/Black Core <b>HC6</b> , CORTEN/Brown Core <b>HC7</b> , DARK GREY/Black Core <b>HGW</b>  |
| <b>HH3</b> | ST WHITE/White Core <b>AB4</b> , ST SAND/Sand Core <b>ACR</b> , ST GRAPHITE GREY/ Grafite Core <b>AGD</b> , ST BLACK/Black Core <b>AN4</b> , ST TORTORA/Tortora Core <b>ATR</b> , ST RED NAMIB/Red Core <b>FAM</b> , ST YELLOW EVORA/Yellow Core <b>FGO</b> , ST RED BULGARO/Red Core <b>FRB</b> , ST GREEN KITAMI/Green Core <b>FVK</b> |

**Top finishes**

**Glass**

|            |   |
|------------|---|
| <b>GVC</b> | MATT GRAFITE ANTISCRATCH <b>J31</b> , MATT SAND ANTISCRATCH <b>J32</b>  |
| <b>GVD</b> | EXTRA CLEAR MATT WHITE ANTISCRATCH <b>J41</b>   |
| <b>GVB</b> | EXTRA CLEAR GLOSSY WHITE <b>J21</b> , EXTRA CLEAR GLOSSY CHERRY RED <b>J25</b> , EXTRA CLEAR GLOSSY BLUE SAPPHIRE <b>J26</b> , EXTRA CLEAR GLOSSY BLUE TURQUOISE <b>J27</b> |

**Crystal Ceramic and Ceramic**

|            |   |
|------------|---|
| <b>GMA</b> | MARBLE CALACATTA GLOSSY WHITE <b>K32</b> , BLACK GREEK MARBLE <b>K33</b> , MARBLE GLOSSY NOIR DESIR <b>K35</b> , MARBLE CALACATTA MATT WHITE <b>K42</b> , MARBLE MATT NOIR DESIR <b>K45</b> , MARBLE MATT GREEN TINOS <b>K46</b> , MARBLE STATUARIO WHITE MATT <b>K47</b> , MARBLE CALACAT BLACK Bush Hammered <b>K50</b> |
|------------|---|

**Legs finishes**

**Solid ashwood**

|            |  |
|------------|--|
| <b>LFI</b> | Ash wood stained BLACK <b>F04</b> , Ash wood stained WHITE <b>F05</b> , Ash wood stained CHERRY RED <b>F09</b> , Ash wood stained FLAMED WALNUT <b>F24</b> , Ash wood stained DARK BROWN <b>F26</b> , Ash wood stained NATURAL <b>F40</b> , Ash wood stained NATURAL OAK <b>F52</b> , Ash wood stained WHITENED <b>F60</b> , Ash wood stained DESERT <b>F61</b> , Ash wood stained LIGHT GREY <b>F62</b> , Ash wood stained DARK GREY <b>F63</b> |
|------------|--|

**Veneer**

|            |  |
|------------|--|
| <b>LII</b> | Stained BLACK <b>I04</b> , Stained WHITE <b>I05</b> , Stained CHERRY RED <b>I09</b> , Stained DARK BROWN <b>I26</b> , Stained NATURAL <b>I40</b> , Stained NATURAL OAK <b>I52</b> , Stained WHITENED <b>I60</b> , Stained DESERT <b>I61</b> , Stained LIGHT GREY <b>I62</b> , Stained DARK GREY <b>I63</b> |
| <b>LI2</b> | NATURAL OAK <b>I22</b> , FLAMED WALNUT <b>I24</b>  |

**Crystal Ceramic and Ceramic**

|            |  |
|------------|--|
| <b>GKA</b> | CHARCOAL SAVOIA <b>K11</b> , CEMENT SAVOIA <b>K12</b>  |
| <b>GKB</b> | WHITE CALCE <b>K24</b> , BLACK CALCE <b>K25</b> , TORTORA CALCE <b>K26</b> , PIASENTINA STONE TAUPE Materica <b>K55</b> , TERRACOTTA Matt <b>K90</b> , MATT GREEN <b>K91</b> |

**Optionals:**

|              |                      | Value   | Options/notes  |
|--------------|----------------------|---------|--|
| <b>FM-M2</b> | Indoor matt metal M2 | + 180 € | ASH GREY <b>ES</b> , BLUE SAPPHIRE <b>EE</b> , BLUE TURQUOISE <b>EH</b> , BRONZE <b>E2</b> , BULGARO RED <b>FP</b> , CHERRY RED <b>EQ</b> , DARK GREEN <b>EL</b> , FACEPOWDER PINK <b>E8</b> , FANGO <b>E3</b> , GOLDEN YELLOW <b>EO</b> , LIGHT BLUE <b>EO</b> , LIGHT GREY <b>ET</b> , OCEAN BLUE <b>E1</b> , OCHER YELLOW <b>E7</b> , PAPAYA ORANGE <b>EA</b> , PASTEL YELLOW <b>E4</b> , PINE GREEN <b>EJ</b> , RED <b>ER</b> , SAGE GREEN <b>E9</b> |

**100x70**

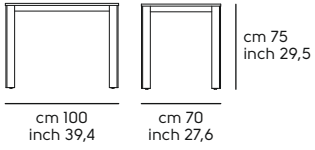

**110x80**

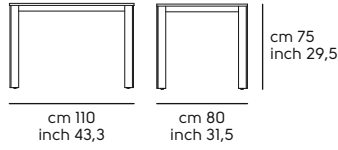

**120x80**

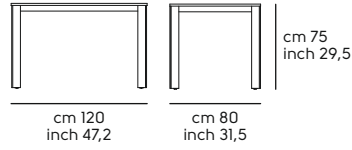

**140x90**

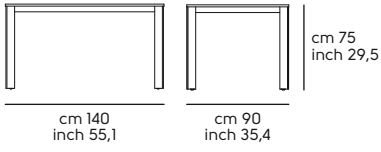

**160x90**

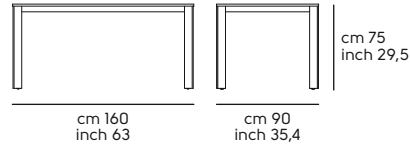

**180x90**

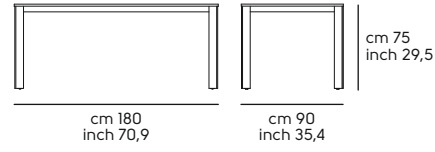

**180x100**

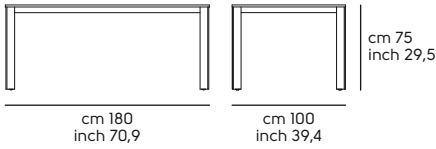

**100/140x70**

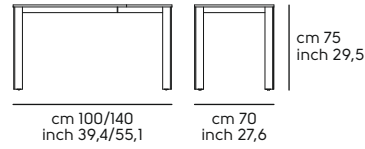

**120/170x80**

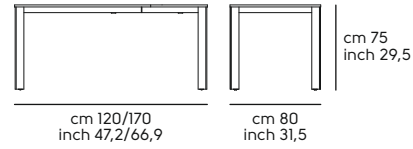

**140/200x90**

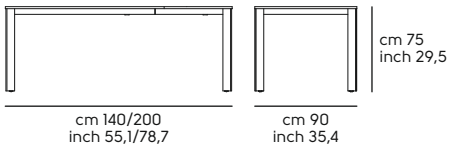

**140/190/240x90**

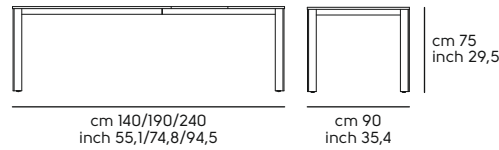

**160/220x90**

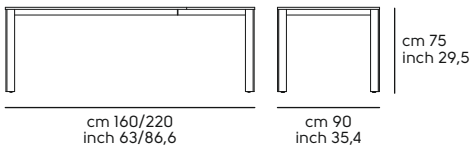

**160/210/260x90**

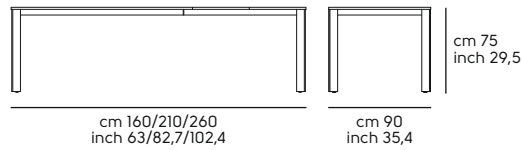

**180/240x90**

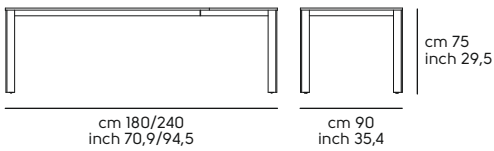

**180/230/280x90**

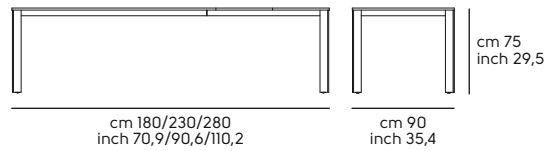

**180/240x100**

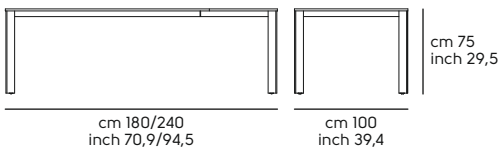

**180/230/280x100**

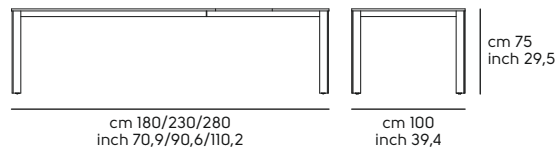

**XL 110/155/200/245 x80**

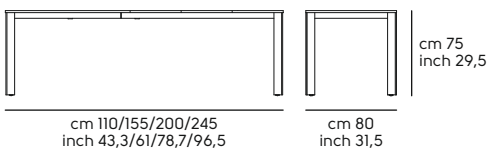

**XL 140/190/240/290 x90**

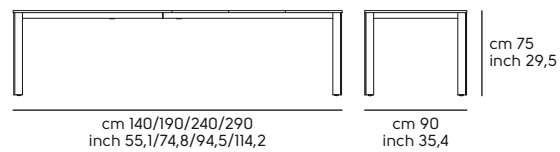

**XL 160/210/260/310 x90**

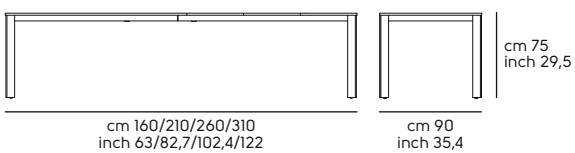

# Brioso design Balutto Associati

## Table Brioso

Frame in: metal



| Version | Code | Legs | Frame | Top | Optional | Q.ty | boxes | Kg | M <sup>3</sup> |
|---------|------|------|-------|-----|----------|------|-------|----|----------------|
|---------|------|------|-------|-----|----------|------|-------|----|----------------|

### Brioso Glass

Top 10 mm. thk

|         |          |    |    | GVB   |                |   |   |    |      |
|---------|----------|----|----|-------|----------------|---|---|----|------|
| 140 x80 | T0150140 |    |    | 757 € | FM-M2<br>FM-M3 | 1 | 3 | 44 | 0.28 |
| 160 x90 | T0150160 | M1 | M1 | 881 € |                | 1 | 3 | 52 | 0.30 |
| 180 x90 | T0150180 |    |    | 930 € |                | 1 | 3 | 56 | 0.32 |

### Brioso Veneer

Top 19 mm. thk

|            |          |    |    | LI2     |                |   |   |    |      |
|------------|----------|----|----|---------|----------------|---|---|----|------|
| 140 x90_LG | T0150149 | M1 | M1 | 1.048 € | FM-M2<br>FM-M3 | 1 | 3 | 44 | 0.28 |
| 160 x90_LG | T0150160 |    |    | 1.126 € |                | 1 | 3 | 52 | 0.30 |

### Frame finishes

#### Metal

**M1** WHITE **BB**, INDUSTRIAL **E5**, BROWN **E6**, SAND **EC**, WHITE PEARL **EF**, GRAPHITE **EG**, BLACK **EN**

### Legs finishes

#### Metal

**M1** WHITE **BB**, INDUSTRIAL **E5**, BROWN **E6**, SAND **EC**, WHITE PEARL **EF**, GRAPHITE **EG**, BLACK **EN**

### Top finishes

#### Veneer

**LI2** NATURAL OAK **I22**, FLAMED WALNUT **I24**

#### Glossy Glass

**GVB** EXTRA CLEAR TRANSPARENT **J01**, EXTRA CLEAR GLOSSY BLUE SAPPHIRE **J26**, EXTRA CLEAR GLOSSY BLUE TURQUOISE **J27**

### Optionals:

|              |                        | Value   | Options/notes  |
|--------------|------------------------|---------|--|
| <b>FM-M2</b> | Indoor matt metal M2   | + 104 € | ASH GREY <b>ES</b> , BLUE SAPPHIRE <b>EE</b> , BLUE TURQUOISE <b>EH</b> , BRONZE <b>E2</b> , BULGARO RED <b>FP</b> , CHERRY RED <b>EQ</b> , DARK GREEN <b>EL</b> , FACEPOWDER PINK <b>E8</b> , FANGO <b>E3</b> , GOLDEN YELLOW <b>EO</b> , LIGHT BLUE <b>EO</b> , LIGHT GREY <b>ET</b> , OCEAN BLUE <b>E1</b> , OCHER YELLOW <b>E7</b> , PAPAYA ORANGE <b>EA</b> , PASTEL YELLOW <b>E4</b> , PINE GREEN <b>EJ</b> , RED <b>ER</b> , SAGE GREEN <b>E9</b> |
| <b>FM-M3</b> | Indoor glossy metal M3 | + 58 €  | CHROME <b>CC</b>   |

### 140 x80

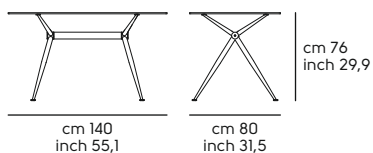

### 160 x90

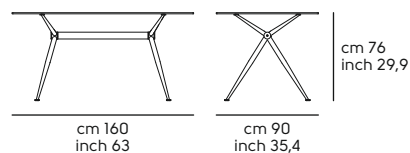

### 180 x90

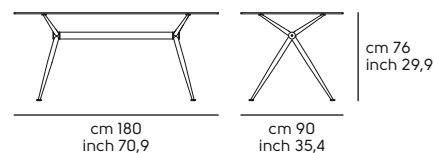

# Clessidra design Paolo Vernier

## Table Clessidra

Frame in: metal or wood with metal insert



T  
A  
B  
L  
E  
S

| Version | Code | Insert | Frame | Top | Optional | Q.ty | boxes | Kg | M <sup>3</sup> |
|---------|------|--------|-------|-----|----------|------|-------|----|----------------|
|---------|------|--------|-------|-----|----------|------|-------|----|----------------|

### Clessidra Veneer

Top D.150 20 mm. thk - D.180 25 mm. thk

|        |          |              |     | LI1     | LI2     |                |   |   |     |      |
|--------|----------|--------------|-----|---------|---------|----------------|---|---|-----|------|
| D. 150 | T1960150 | M1-<br>M2-M4 | MI  | 2.692 € | 2.765 € | FM-M2<br>FM-M2 | 1 | 2 | 150 | 0.95 |
| D. 180 | T1960180 |              |     | 3.521 € | 3.877 € | FM-M2<br>FM-M2 | 1 | 2 | 198 | 1.05 |
| D. 150 | T1961150 |              | LI1 | 3.380 € | 3.530 € | FL-I2          | 1 | 2 | 145 | 0.95 |
| D. 180 | T1961180 |              |     | 3.877 € | 4.327 € | FL-I2<br>FL-I2 | 1 | 2 | 190 | 1.05 |

### Clessidra HPL

Top D.150 10 mm. thk

|        |          |              |    | HH3     |  |       |   |   |     |      |
|--------|----------|--------------|----|---------|--|-------|---|---|-----|------|
| D. 150 | T1960150 | M1-<br>M2-M4 | MI | 3.750 € |  | FM-M2 | 1 | 2 | 150 | 0.95 |

### Clessidra Ceramic

Top D.150 16 mm. thk

|        |          |              |     | GMA     |  |       |   |   |     |      |
|--------|----------|--------------|-----|---------|--|-------|---|---|-----|------|
| D. 150 | T1960150 | M1-<br>M2-M4 | MI  | 3.618 € |  | FM-M2 | 1 | 2 | 210 | 0.95 |
| D. 150 | T1961150 |              | LI1 | 4.431 € |  | FL-I2 | 1 | 2 | 200 | 0.95 |

#### Note:

Top D.150 NOT AVAILABLE in GMA K46

### Clessidra Glass

Top D.150 10 mm. thk

|        |          |              |    | GVB     | GVC     | GVD     |       |   |   |     |      |
|--------|----------|--------------|----|---------|---------|---------|-------|---|---|-----|------|
| D. 150 | T1960150 | M1-<br>M2-M4 | MI | 3.343 € | 3.377 € | 3.438 € | FM-M2 | 1 | 2 | 185 | 0.95 |

### Clessidra Marble

Top D.150 20 mm. thk

|        |          |              |     | GMM     |  |       |   |   |     |      |
|--------|----------|--------------|-----|---------|--|-------|---|---|-----|------|
| D. 150 | T1960150 | M1-<br>M2-M4 | MI  | 5.269 € |  | FM-M2 | 1 | 2 | 215 | 0.95 |
| D. 180 | T1960180 |              |     | 6.470 € |  |       | 1 | 2 | 255 | 0.95 |
| D. 150 | T1961150 |              | LI1 | 6.057 € |  | FL-I2 | 1 | 2 | 207 | 0.95 |
| D. 180 | T1961180 |              |     | 7.250 € |  |       | 1 | 2 | 247 | 0.95 |

#### Note:

Top Marble D.180 Only BLACK MARQUINIA [MN4] e WHITE CALACATTA VAGLI [MB4]

## Table Clessidra Double

Frame in: metal or wood with metal insert



| Version | Code | Insert | Frame | Top | Optional | Q.ty | boxes | Kg | M³ |
|---------|------|--------|-------|-----|----------|------|-------|----|----|
|---------|------|--------|-------|-----|----------|------|-------|----|----|

### Clessidra Veneer

Top 25 mm. thk

|                |          |       |     | L11     | L12     |       |   |   |     |     |
|----------------|----------|-------|-----|---------|---------|-------|---|---|-----|-----|
| 300x150 Barrel | T1960300 | M1-   | M1  | 4.974 € | 5.670 € | FM-M2 | 1 | 3 | 335 | 1.7 |
| 300x150 Barrel | T1961300 | M2-M4 | L11 | 5.224 € | 5.920 € | FL-I2 | 1 | 3 | 319 | 1.7 |

### Clessidra Ceramic

Top 18 mm. thk

|                |          |       |     | GMA     |         |       |   |   |     |     |
|----------------|----------|-------|-----|---------|---------|-------|---|---|-----|-----|
| 300x150 Barrel | T1960300 | M1-   | M1  | 5.242 € | 5.492 € | FM-M2 | 1 | 3 | 474 | 1.7 |
| 300x150 Barrel | T1961300 | M2-M4 | L11 | 5.492 € |         | FL-I2 | 1 | 3 | 458 | 1.7 |

### Frame finishes

#### Metal

|           |  |
|-----------|--|
| <b>M1</b> | WHITE <b>BB</b> , INDUSTRIAL <b>E5</b> , BROWN <b>E6</b> , SAND <b>EC</b> , WHITE PEARL <b>EF</b> , GRAPHITE <b>EG</b> , BLACK <b>EN</b> |
|-----------|--|

#### Veneer

|            |  |
|------------|--|
| <b>L11</b> | Veneered wood painted BLACK <b>I04</b> , Veneered wood painted WHITE <b>I05</b> , Veneered wood painted CHERRY RED <b>I09</b> , Veneered wood painted DARK BROWN <b>I26</b> , Veneered wood painted NATURAL <b>I40</b> , Veneered wood painted NATURAL OAK <b>I52</b> , Veneered wood painted WHITENED <b>I60</b> , Veneered wood painted DESERT <b>I61</b> , Veneered wood painted LIGHT GREY <b>I62</b> , Veneered wood painted DARK GREY <b>I63</b> |
|------------|--|

### Insert finishes

#### Metal

|           |   |
|-----------|---|
| <b>M1</b> | WHITE <b>BB</b> , INDUSTRIAL <b>E5</b> , BROWN <b>E6</b> , SAND <b>EC</b> , WHITE PEARL <b>EF</b> , GRAPHITE <b>EG</b> , BLACK <b>EN</b>  |
| <b>M2</b> | LIGHT BLUE <b>E0</b> , OCEAN BLUE <b>E1</b> , FANGO <b>E3</b> , PASTEL YELLOW <b>E4</b> , OCHER YELLOW <b>E7</b> , FACEPOWDER PINK <b>E8</b> , SAGE GREEN <b>E9</b> , PAPAYA ORANGE <b>EA</b> , BLUE SAPPHIRE <b>EE</b> , BLUE TURQUOISE <b>EH</b> , PINE GREEN <b>EJ</b> , DARK GREEN <b>EL</b> , GOLDEN YELLOW <b>EO</b> , CHERRY RED <b>EQ</b> , RED <b>ER</b> , ASH GREY <b>ES</b> , LIGHT GREY <b>ET</b> , BRONZE <b>EZ</b> + TRANSP., BULGARO RED <b>FP</b> |

|           |  |
|-----------|--|
| <b>M4</b> | GOLDEN BRONZE <b>DB</b> , MATT GOLDEN BRONZE <b>DC</b> , CHAMPAGNE GOLD <b>DG</b> , PINK GOLD <b>DR</b> , MATT BLACK NICKEL <b>DY</b> , BLACK NICKEL <b>DZ</b> |
|-----------|--|

### Top finishes

#### Veneer

|            |   |
|------------|---|
| <b>L11</b> | Stained BLACK <b>I04</b> , Stained WHITE <b>I05</b> , Stained NATURAL <b>I40</b> , Stained WHITENED <b>I60</b> , Stained DESERT <b>I61</b> , Stained LIGHT GREY <b>I62</b> , Stained DARK GREY <b>I63</b> |
| <b>L12</b> | NATURAL OAK <b>I22</b> , FLAMED WALNUT <b>I24</b>   |

#### HPL

|            |  |
|------------|--|
| <b>HH3</b> | ST WHITE/White Core <b>AB4</b> , ST SAND/Sand Core <b>ACR</b> , ST GRAPHITE GREY/Grafitte Core <b>AGD</b> , ST BLACK/Black Core <b>AN4</b> , ST TORTORA/Tortora Core <b>ATR</b> , ST RED NAMIB/Red Core <b>FAM</b> , ST YELLOW EVORA/Yellow Core <b>FGO</b> , ST RED BULGARO/Red Core <b>FRB</b> , ST GREEN KITAMI/Green Core <b>FVK</b> |
|------------|--|

### Crystal Ceramic and Ceramic

|            |  |
|------------|--|
| <b>GMA</b> | MARBLE CALACATTA GLOSSY WHITE <b>K32</b> , BLACK GREEK MARBLE <b>K33</b> , MARBLE GLOSSY NOIR DESIR <b>K35</b> , MARBLE CALACATTA MATT WHITE <b>K42</b> , MARBLE MATT NOIR DESIR <b>K45</b> , MARBLE STATUARIO WHITE MATT <b>K47</b> , MARBLE CALACAT BLACK Bush Hammered <b>K50</b> |
|------------|--|

### Marble

|            |   |
|------------|---|
| <b>GMM</b> | BEIGE TRAVERTINO ROMANO <b>MB2</b> , WHITE CALACATTA VAGLI <b>MB4</b> , BLACK MARQUINIA <b>MN4</b> , GREEN TINOS <b>MVE</b> |
|------------|---|

### Glass

|            |   |
|------------|---|
| <b>GVB</b> | EXTRA CLEAR GLOSSY CHERRY RED <b>J25</b> , EXTRA CLEAR GLOSSY BLUE SAPPHIRE <b>J26</b> , EXTRA CLEAR GLOSSY BLUE TURQUOISE <b>J27</b> |
| <b>GVC</b> | MATT GRAFITE ANTISCRATCH <b>J31</b> , MATT SAND ANTISCRATCH <b>J32</b>  |
| <b>GVD</b> | EXTRA CLEAR MATT WHITE ANTISCRATCH <b>J41</b>   |

| Optionals:   |                          |         |   |
|--------------|--------------------------|---------|---|
|              |                          | Value   | Options/notes   |
| <b>FM-M2</b> | Indoor matt metal M2     | + 122 € | ASH GREY <b>ES</b> , BLUE SAPPHIRE <b>EE</b> , BLUE TURQUOISE <b>EH</b> , BRONZE <b>EZ</b> + TRANSP., BULGARO RED <b>FP</b> , CHERRY RED <b>EQ</b> , DARK GREEN <b>EL</b> , FACEPOWDER PINK <b>E8</b> , FANGO <b>E3</b> , GOLDEN YELLOW <b>EO</b> , LIGHT BLUE <b>EO</b> , LIGHT GREY <b>ET</b> , OCEAN BLUE <b>E1</b> , OCHER YELLOW <b>E7</b> , PAPAYA ORANGE <b>EA</b> , PASTEL YELLOW <b>E4</b> , PINE GREEN <b>EJ</b> , RED <b>ER</b> , SAGE GREEN <b>E9</b> |
| <b>FL-I2</b> | Veneered wood finish LI2 | + 204 € | Veneered wood FLAMED WALNUT <b>I24</b> , Veneered wood NATURAL OAK <b>I22</b>   |

### Table Clessidra Elliptical

Frame in: metal with metal insert



| Version | Code | Insert | Frame | Top | Optional | Q.ty | boxes | Kg | M³ |
|---------|------|--------|-------|-----|----------|------|-------|----|----|
|---------|------|--------|-------|-----|----------|------|-------|----|----|

#### Clessidra Veneer

Top 19 mm. thk

|                    |          |       |    | LI1     | LI2     |       |   |   |     |     |
|--------------------|----------|-------|----|---------|---------|-------|---|---|-----|-----|
| 220x120 Elliptical | T1960220 | M1-   | M1 | 3.750 € | 4.190 € | FM-M2 | 1 | 2 | 170 | 0.9 |
| 250x120 Elliptical | T1960250 | M2-M4 |    | 3.880 € | 4.350 € |       | 1 | 2 | 180 | 1   |

#### Clessidra Glass

Top 12 mm. thk

|                    |          |       |    | GVB     | GVC     | GVD     |       |   |   |     |      |
|--------------------|----------|-------|----|---------|---------|---------|-------|---|---|-----|------|
| 220x120 Elliptical | T1960220 | M1-   | M1 | 3.390 € | 3.450 € | 3.530 € | FM-M2 | 1 | 2 | 213 | 1.00 |
| 250x120 Elliptical | T1960250 | M2-M4 |    | 3.540 € | 3.620 € | 3.710 € |       | 1 | 2 | 230 | 1.10 |

#### Clessidra Ceramic

Top 12 mm. thk

|                    |          |       |    | GKA     | GKB     | GMA     |       |   |   |     |      |
|--------------------|----------|-------|----|---------|---------|---------|-------|---|---|-----|------|
| 220x120 Elliptical | T1960220 | M1-   | M1 | 4.560 € | 4.786 € | 5.220 € | FM-M2 | 1 | 2 | 207 | 1.00 |
| 250x120 Elliptical | T1960250 | M2-M4 |    | 4.710 € | 4.986 € | 5.430 € |       | 1 | 2 | 223 | 1.10 |

#### Clessidra Marble

Top 20 mm. thk

|                    |          |       |    | GMM     |       |   |   |     |      |
|--------------------|----------|-------|----|---------|-------|---|---|-----|------|
| 220x120 Elliptical | T1960220 | M1-   | M1 | 5.544 € | FM-M2 | 1 | 2 | 260 | 1.00 |
| 250x120 Elliptical | T1960250 | M2-M4 |    | 5.944 € |       | 1 | 2 | 282 | 1.10 |

**Frame finishes****Metal**

|           |   |
|-----------|---|
| <b>M1</b> | WHITE <b>BB</b> , BROWN <b>E6</b> , SAND <b>EC</b> , WHITE PEARL <b>EF</b> , GRAPHITE <b>EG</b> , BLACK <b>EN</b> |
|-----------|---|

**Insert finishes****Metal**

|           |   |
|-----------|---|
| <b>M1</b> | WHITE <b>BB</b> , BROWN <b>E6</b> , SAND <b>EC</b> , WHITE PEARL <b>EF</b> , GRAPHITE <b>EG</b> , BLACK <b>EN</b>   |
| <b>M2</b> | LIGHT BLUE <b>E0</b> , OCEAN BLUE <b>E1</b> , FANGO <b>E3</b> , PASTEL YELLOW <b>E4</b> , OCHER YELLOW <b>E7</b> , FACEPOWDER PINK <b>E8</b> , SAGE GREEN <b>E9</b> , PAPAYA ORANGE <b>EA</b> , BLUE SAPPHIRE <b>EE</b> , BLUE TURQUOISE <b>EH</b> , PINE GREEN <b>EJ</b> , DARK GREEN <b>EL</b> , GOLDEN YELLOW <b>EO</b> , CHERRY RED <b>EQ</b> , RED <b>ER</b> , ASH GREY <b>ES</b> , LIGHT GREY <b>ET</b> , BRONZE <b>EZ</b> + TRANSP., BULGARO RED <b>FP</b> |
| <b>M4</b> | GOLDEN BRONZE <b>DB</b> , MATT GOLDEN BRONZE <b>DC</b> , CHAMPAGNE GOLD <b>DG</b> , PINK GOLD <b>DR</b> , MATT BLACK NICKEL <b>DY</b> , BLACK NICKEL <b>DZ</b>  |

**Top finishes****Veneer**

|            |   |
|------------|---|
| <b>LI1</b> | Stained BLACK <b>I04</b> , Stained WHITE <b>I05</b> , Stained NATURAL <b>I40</b> , Stained WHITENED <b>I60</b> , Stained DESERT <b>I61</b> , Stained LIGHT GREY <b>I62</b> , Stained DARK GREY <b>I63</b> |
| <b>LI2</b> | NATURAL OAK <b>I22</b> , FLAMED WALNUT <b>I24</b>   |

**Glass**

|            |   |
|------------|---|
| <b>GVB</b> | EXTRA CLEAR GLOSSY CHERRY RED <b>J25</b> , EXTRA CLEAR GLOSSY BLUE SAPPHIRE <b>J26</b> , EXTRA CLEAR GLOSSY BLUE TURQUOISE <b>J27</b> |
| <b>GVC</b> | MATT GRAFITE ANTISCRATCH <b>J31</b> , MATT SAND ANTISCRATCH <b>J32</b>  |
| <b>GVD</b> | EXTRA CLEAR MATT WHITE ANTISCRATCH <b>J41</b>   |

**Ceramic**

|            |  |
|------------|--|
| <b>GKA</b> | CHARCOAL SAVOIA <b>K11</b> , CEMENT SAVOIA <b>K12</b>  |
| <b>GKB</b> | WHITE CALCE <b>K24</b> , BLACK CALCE <b>K25</b> , TORTORA CALCE <b>K26</b> , PIASENTINA STONE TAUPE Materica <b>K55</b>  |
| <b>GMA</b> | MARBLE CALACATTA GLOSSY WHITE <b>K32</b> , BLACK GREEK MARBLE <b>K33</b> , MARBLE GLOSSY NOIR DESIR <b>K35</b> , MARBLE MATT NOIR DESIR <b>K45</b> , MARBLE MATT GREEN TINOS <b>K46</b> , MARBLE STATUARIO WHITE MATT <b>K47</b> , MARBLE CALACAT BLACK Bush Hammered <b>K50</b> |

**Marble**

|            |   |
|------------|---|
| <b>GMM</b> | BEIGE TRAVERTINO ROMANO <b>MB2</b> , WHITE CALACATTA VAGLI <b>MB4</b> , BLACK MARQUINIA <b>MN4</b> , GREEN TINOS <b>MVE</b> |
|------------|---|

**Optionals:**

|              |                      | Value   | Options/notes   |
|--------------|----------------------|---------|---|
| <b>FM-M2</b> | Indoor matt metal M2 | + 190 € | ASH GREY <b>ES</b> , BLUE SAPPHIRE <b>EE</b> , BLUE TURQUOISE <b>EH</b> , BRONZE <b>EZ</b> + TRANSP., BULGARO RED <b>FP</b> , CHERRY RED <b>EQ</b> , DARK GREEN <b>EL</b> , FACEPOWDER PINK <b>E8</b> , FANGO <b>E3</b> , GOLDEN YELLOW <b>EO</b> , LIGHT BLUE <b>E0</b> , LIGHT GREY <b>ET</b> , OCEAN BLUE <b>E1</b> , OCHER YELLOW <b>E7</b> , PAPAYA ORANGE <b>EA</b> , PASTEL YELLOW <b>E4</b> , PINE GREEN <b>EJ</b> , RED <b>ER</b> , SAGE GREEN <b>E9</b> |

## Table Clessidra D.100-120

Frame in: metal with metal insert



| Version | Code | Insert | Frame | Top | Optional | Q.ty | boxes | Kg | M³ |
|---------|------|--------|-------|-----|----------|------|-------|----|----|
|---------|------|--------|-------|-----|----------|------|-------|----|----|

### Clessidra Melamine HL

Top 20 mm. thk

|        |          |       |    | HL1     |       |   |   |    |      |   |
|--------|----------|-------|----|---------|-------|---|---|----|------|---|
| D. 100 | T1960100 | M1-   | MI | 1.216 € | FM-M2 | 1 | 2 | 57 | 0.25 |   |
| D. 120 | T1960120 | M2-M4 |    | 1.301 € |       |   |   |    |      | 1 |

### Clessidra HPL

Top 10 mm. thk

|        |          |       |    | HH1     | HH2     | HH3     |       |   |   |    |    |
|--------|----------|-------|----|---------|---------|---------|-------|---|---|----|----|
| D. 100 | T1960100 | M1-   | MI | 1.610 € | 1.705 € | 1.990 € | FM-M2 | 1 | 2 | -- | -- |
| D. 120 | T1960120 | M2-M4 |    | 1.698 € | 1.852 € | 2.310 € |       |   |   |    |    |

### Clessidra Veneer

Top 20 mm. thk

|        |          |       |    | LI1     | LI2     |       |   |   |    |      |
|--------|----------|-------|----|---------|---------|-------|---|---|----|------|
| D. 100 | T1960100 | M1-   | MI | 1.596 € | 1.682 € | FM-M2 | 1 | 2 | 58 | 0.25 |
| D. 120 | T1960120 | M2-M4 |    | 1.698 € | 1.786 € |       |   |   |    |      |

### Clessidra Glass

Top 10 mm. thk

|        |          |       |    | GVB     | GVC     | GVD     |       |   |   |    |      |
|--------|----------|-------|----|---------|---------|---------|-------|---|---|----|------|
| D. 100 | T1960100 | M1-   | MI | 1.585 € | 1.768 € | 1.864 € | FM-M2 | 1 | 2 | 72 | 0.25 |
| D. 120 | T1960120 | M2-M4 |    | 1.762 € | 1.940 € | 2.062 € |       |   |   |    |      |

### Clessidra Ceramic

Top 16 mm. thk

|        |          |       |    | GKB     | GMA     |       |   |   |    |      |
|--------|----------|-------|----|---------|---------|-------|---|---|----|------|
| D. 100 | T1960100 | M1-   | MI | 1.990 € | 2.110 € | FM-M2 | 1 | 2 | 78 | 0.25 |
| D. 120 | T1960120 | M2-M4 |    | 2.295 € | 2.403 € |       |   |   |    |      |

### Clessidra Marble

Top 20 mm. thk

|        |          |       |    | GMM     |       |   |   |    |      |   |
|--------|----------|-------|----|---------|-------|---|---|----|------|---|
| D. 100 | T1960100 | M1-   | MI | 2.646 € | FM-M2 | 1 | 2 | 92 | 0.25 |   |
| D. 120 | T1960120 | M2-M4 |    | 2.940 € |       |   |   |    |      | 1 |

#### Note:

Top Ceramic K26 D.100 reduced diameter - D.120 NOT available - Top Ceramic K55,K90,K91 D.120 reduced diameter

#### Optionals:

|              |                      | Value  | Options/notes   |
|--------------|----------------------|--------|---|
| <b>FM-M2</b> | Indoor matt metal M2 | + 82 € | ASH GREY <b>ES</b> , BLUE SAPPHIRE <b>EE</b> , BLUE TURQUOISE <b>EH</b> , BRONZE <b>EZ</b> + TRANSP., BULGARO RED <b>FP</b> , CHERRY RED <b>EQ</b> , DARK GREEN <b>EL</b> , FACEPOWDER PINK <b>E8</b> , FANGO <b>E3</b> , GOLDEN YELLOW <b>EO</b> , LIGHT BLUE <b>E0</b> , LIGHT GREY <b>ET</b> , OCEAN BLUE <b>EI</b> , OCHER YELLOW <b>E7</b> , PAPAYA ORANGE <b>EA</b> , PASTEL YELLOW <b>E4</b> , PINE GREEN <b>EJ</b> , RED <b>ER</b> , SAGE GREEN <b>E9</b> |

**Lazy Susan**

Top Ceramic, Marble



| Version                   | Code     | Top Thickness | -- | Top   | Optional | Q.ty | boxes | Kg | M <sup>2</sup> |
|---------------------------|----------|---------------|----|-------|----------|------|-------|----|----------------|
| <b>Lazy Susan Ceramic</b> |          |               |    |       |          |      |       |    |                |
| Top Ø60 6 mm thk          |          |               |    |       |          |      |       |    |                |
|                           |          |               |    | GMA   |          |      |       |    |                |
| LS D. 60 H. 2.6           | A2220060 | 0.6           |    | 371 € |          | 1    | 1     | 7  | 0.01           |

|                          |          |   |  |       |  |   |   |    |      |
|--------------------------|----------|---|--|-------|--|---|---|----|------|
| <b>Lazy Susan Marble</b> |          |   |  |       |  |   |   |    |      |
| Top Ø60 20 mm thk        |          |   |  |       |  |   |   |    |      |
|                          |          |   |  | GMM   |  |   |   |    |      |
| LS D. 60 H. 4.0          | A2220060 | 2 |  | 655 € |  | 1 | 1 | 16 | 0.02 |

**Frame finishes**

| Metal     |  |
|-----------|--|
| <b>M1</b> | WHITE <b>BB</b> , INDUSTRIAL <b>E5</b> , BROWN <b>E6</b> , SAND <b>EC</b> , WHITE PEARL <b>EF</b> , GRAPHITE <b>EG</b> , BLACK <b>EN</b> |

**Insert finishes**

| Metal     |   |
|-----------|---|
| <b>M1</b> | WHITE <b>BB</b> , BROWN <b>E6</b> , SAND <b>EC</b> , WHITE PEARL <b>EF</b> , GRAPHITE <b>EG</b> , BLACK <b>EN</b>   |
| <b>M2</b> | LIGHT BLUE <b>E0</b> , OCEAN BLUE <b>E1</b> , BRONZE <b>E2</b> , FANGO <b>E3</b> , PASTEL YELLOW <b>E4</b> , OCHER YELLOW <b>E7</b> , FACEPOWDER PINK <b>E8</b> , SAGE GREEN <b>E9</b> , PAPAYA ORANGE <b>EA</b> , PINE GREEN <b>EJ</b> , DARK GREEN <b>EL</b> , GOLDEN YELLOW <b>EO</b> , CHERRY RED <b>EQ</b> , RED <b>ER</b> , ASH GREY <b>ES</b> , LIGHT GREY <b>ET</b> , BULGARO RED <b>FP</b> |
| <b>M4</b> | GOLDEN BRONZE <b>DB</b> , MATT GOLDEN BRONZE <b>DC</b> , CHAMPAGNE GOLD <b>DG</b> , PINK GOLD <b>DR</b> , MATT BLACK NICKEL <b>DY</b> , BLACK NICKEL <b>DZ</b>  |

Veneer

|            |   |
|------------|---|
| <b>L11</b> | Stained BLACK <b>I04</b> , Stained WHITE <b>I05</b> , Stained NATURAL <b>I40</b> , Stained WHITENED <b>I60</b> , Stained DESERT <b>I61</b> , Stained LIGHT GREY <b>I62</b> , Stained DARK GREY <b>I63</b> |
| <b>L12</b> | NATURAL OAK <b>I22</b> , FLAMED WALNUT <b>I24</b>   |

Marble

|            |   |
|------------|---|
| <b>GMM</b> | BEIGE TRAVERTINO ROMANO <b>MB2</b> , WHITE CALACATTA VAGLI <b>MB4</b> , BLACK MARQUINIA <b>MN4</b> , GREEN TINOS <b>MVE</b> |
|------------|---|

Melamine

|            |  |
|------------|--|
| <b>HL1</b> | WHITE <b>M01</b> , GRAFITE <b>M02</b> , BLACK <b>M04</b> , SAND <b>M07</b> |
|------------|--|

Crystal Ceramic and Ceramic

|            |   |
|------------|---|
| <b>GKB</b> | WHITE CALCE <b>K24</b> , BLACK CALCE <b>K25</b> , TORTORA CALCE <b>K26</b> , PIASENTINA STONE TAUPE Materica <b>K55</b> , TERRACOTTA Matt <b>K90</b> , MATT GREEN <b>K91</b>  |
| <b>GMA</b> | MARBLE CALACATTA GLOSSY WHITE <b>K32</b> , BLACK GREEK MARBLE <b>K33</b> , MARBLE GLOSSY NOIR DESIR <b>K35</b> , MARBLE CALACATTA MATT WHITE <b>K42</b> , MARBLE MATT NOIR DESIR <b>K45</b> , MARBLE MATT GREEN TINOS <b>K46</b> , MARBLE STATUARIO WHITE MATT <b>K47</b> , MARBLE CALACAT BLACK Bush Hammered <b>K50</b> |

Glass

|            |   |
|------------|---|
| <b>GVB</b> | EXTRA CLEAR GLOSSY CHERRY RED <b>J25</b> , EXTRA CLEAR GLOSSY BLUE SAPPHIRE <b>J26</b> , EXTRA CLEAR GLOSSY BLUE TURQUOISE <b>J27</b> |
| <b>GVC</b> | MATT GRAFITE ANTISCRATCH <b>J31</b> , MATT SAND ANTISCRATCH <b>J32</b>  |
| <b>GVD</b> | EXTRA CLEAR MATT WHITE ANTISCRATCH <b>J41</b>   |

HPL

|            |  |
|------------|--|
| <b>HH1</b> | WHITE/Black Core <b>HB4</b> , BLACK/Black Core <b>HN4</b>  |
| <b>HH2</b> | CEMENT/Black Core <b>HC6</b> , CORTEN/Brown Core <b>HC7</b> , DARK GREY/Black Core <b>HGW</b>  |
| <b>HH3</b> | ST WHITE/White Core <b>AB4</b> , ST SAND/Sand Core <b>ACR</b> , ST GRAPHITE GREY/ Grafite Core <b>AGD</b> , ST BLACK/Black Core <b>AN4</b> , ST TORTORA/Tortora Core <b>ATR</b> , ST RED NAMIB/Red Core <b>FAM</b> , ST YELLOW EVORA/Yellow Core <b>FGO</b> , ST RED BULGARO/Red Core <b>FRB</b> , ST GREEN KITAMI/Green Core <b>FBK</b> |

D. 100

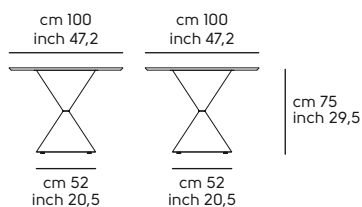

D. 120

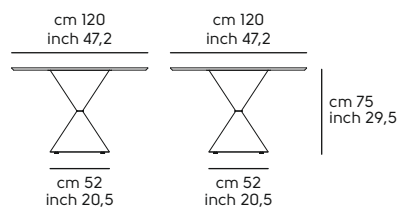

D. 150

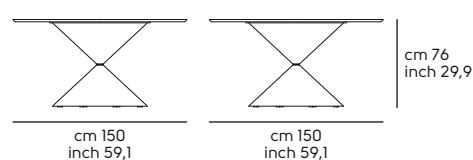

D. 180

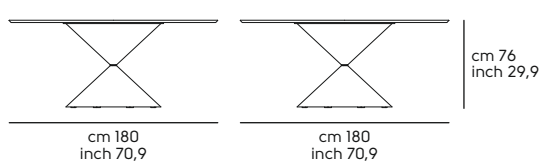

220x120 Elliptical

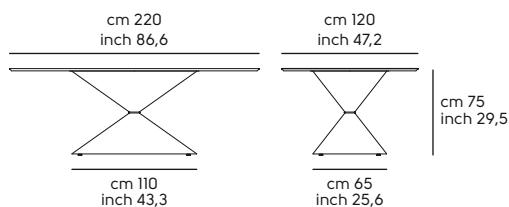

250x120 Elliptical

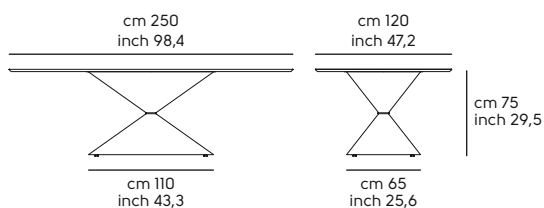

300x150 Barrel

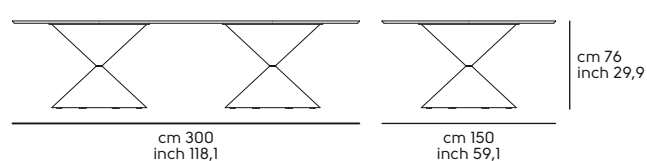

LS D. 60

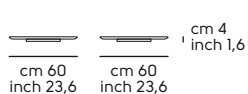

# Dama design Jacopo Maria Giagnoni

## Desk Dama

Frame in: metal



| Version | Code | Legs | Frame | Top | Optional | Q.ty | boxes | Kg | M <sup>3</sup> |
|---------|------|------|-------|-----|----------|------|-------|----|----------------|
|---------|------|------|-------|-----|----------|------|-------|----|----------------|

### Dama Melamine HL

Top 18 mm. thk

|         |          |    |    | HL1   |                |   |   |      |       |
|---------|----------|----|----|-------|----------------|---|---|------|-------|
| 140x 80 | T2070140 |    |    | 645 € | FM-M2<br>ZZ-PC | 1 | 3 | 37.2 | 0.333 |
| 160x 80 | T2070160 | M1 | M1 | 678 € |                | 1 | 3 | 40.6 | 0.369 |
| 200x100 | T2070200 |    |    | 824 € |                | 1 | 3 | 52.5 | 0.556 |

### Dama Veneer

Top 19 mm. thk

|         |          |    |    | LI1     |                |   |   |      |       |
|---------|----------|----|----|---------|----------------|---|---|------|-------|
| 140x 80 | T2070140 |    |    | 966 €   | FM-M2<br>ZZ-PC | 1 | 3 | 37.2 | 0.333 |
| 160x 80 | T2070160 | M1 | M1 | 1.028 € |                | 1 | 3 | 40.6 | 0.369 |
| 200x100 | T2070200 |    |    | 1.323 € |                | 1 | 3 | 52.5 | 0.556 |

### Dama HPL

Top 10 mm. thk

|         |          |    |    | HH1     | HH2     | HH3     |                |   |   |       |       |
|---------|----------|----|----|---------|---------|---------|----------------|---|---|-------|-------|
| 140x 80 | T2070140 |    |    | 914 €   | 1.036 € | 1.107 € | FM-M2<br>ZZ-PC | 1 | 3 | 40    | 0.333 |
| 160x 80 | T2070160 | M1 | M1 | 983 €   | 1.115 € | 1.220 € |                | 1 | 3 | 43.75 | 0.369 |
| 200x100 | T2070200 |    |    | 1.191 € | 1.410 € | 1.585 € |                | 1 | 3 | 57.9  | 0.556 |

### Dama Metal

Top 15 mm. thk (Hydrophobic MDF 12 mm thk+metal)

|            |          |    |    | M1      | M2      |       |   |   |      |       |
|------------|----------|----|----|---------|---------|-------|---|---|------|-------|
| 140x 80_MT | T2071140 |    |    | 809 €   | 864 €   | FM-M2 | 1 | 3 | 43.9 | 0.333 |
| 160x 80_MT | T2071160 | M1 | M1 | 850 €   | 926 €   |       | 1 | 3 | 48   | 0.369 |
| 200x100_MT | T2071200 |    |    | 1.025 € | 1.123 € |       | 1 | 3 | 64.3 | 0.556 |

## Desk Dama H.110

Frame in: metal

| Version | Code | Legs | Frame | Top | Optional | Q.ty | boxes | Kg | M <sup>3</sup> |
|---------|------|------|-------|-----|----------|------|-------|----|----------------|
|---------|------|------|-------|-----|----------|------|-------|----|----------------|

### Dama H.110 Melamine HL

Top 18 mm. thk

|               |          |    |    | HL1   |                |                         |   |      |       |
|---------------|----------|----|----|-------|----------------|-------------------------|---|------|-------|
| 140x 80 H.110 | T2075140 | M1 | M1 | 670 € | FM-M2<br>ZZ-PC | 1                       | 3 | 40.3 | 0.369 |
| 160x 80 H.110 | T2075160 |    |    | 703 € |                | 1                       | 3 | 43.7 | 0.405 |
| 200x100 H.110 | T2075200 | M1 | M1 | 848 € |                | FM-M2<br>ZZ-PC<br>ZZ-PC | 1 | 3    | 55.6  |

### Dama H.110 Veneer

Top 19 mm. thk

|               |          |    |    | LI1     |                |   |   |      |       |
|---------------|----------|----|----|---------|----------------|---|---|------|-------|
| 140x 80 H.110 | T2075140 | M1 | M1 | 990 €   | FM-M2<br>ZZ-PC | 1 | 3 | 40.3 | 0.369 |
| 160x 80 H.110 | T2075160 |    |    | 1.052 € |                | 1 | 3 | 43.7 | 0.405 |
| 200x100 H.110 | T2075200 |    |    | 1.348 € |                | 1 | 3 | 55.6 | 0.592 |

### Dama H.110 HPL

Top 10 mm. thk

|               |          |    |    | HH1     | HH2     | HH3     |                |   |   |       |       |
|---------------|----------|----|----|---------|---------|---------|----------------|---|---|-------|-------|
| 140x 80 H.110 | T2075140 | M1 | M1 | 938 €   | 1.061 € | 1.130 € | FM-M2<br>ZZ-PC | 1 | 3 | 43.1  | 0.369 |
| 160x 80 H.110 | T2075160 |    |    | 1.007 € | 1.140 € | 1.245 € |                | 1 | 3 | 46.85 | 0.405 |
| 200x100 H.110 | T2075200 |    |    | 1.215 € | 1.435 € | 1.610 € |                | 1 | 3 | 61    | 0.592 |

### Dama H.110 Metal

Top 15 mm. thk (Hydrophobic MDF 12 mm thk+metal)

|                  |          |    |    | M1      | M2      |       |   |   |      |       |
|------------------|----------|----|----|---------|---------|-------|---|---|------|-------|
| 140x 80_MT H.110 | T2076140 | M1 | M1 | 833 €   | 888 €   | FM-M2 | 1 | 3 | 47   | 0.369 |
| 160x 80_MT H.110 | T2076160 |    |    | 875 €   | 952 €   |       | 1 | 3 | 51.1 | 0.405 |
| 200x100_MT H.110 | T2076200 |    |    | 1.050 € | 1.149 € |       | 1 | 3 | 67.4 | 0.592 |

#### Note:

Top 140x80 e 160x80 side cable box - Top 200x100 central and side cable box - Top MDF hydrophobic + metal

**Frame finishes**

**Metal**

|           |   |
|-----------|---|
| <b>MI</b> | WHITE <b>BB</b> , BROWN <b>E6</b> , SAND <b>EC</b> , WHITE PEARL <b>EF</b> , GRAPHITE <b>EG</b> , BLACK <b>EN</b> |
|-----------|---|

**Top finishes**

**Melamine**

|            |  |
|------------|--|
| <b>HL1</b> | WHITE <b>M01</b> , GRAFITE <b>M02</b> , BLACK <b>M04</b> , SAND <b>M07</b> |
|------------|--|

**HPL**

|            |  |
|------------|--|
| <b>HH1</b> | WHITE/Black Core <b>HB4</b> , BLACK/Black Core <b>HN4</b>  |
| <b>HH2</b> | CEMENT/Black Core <b>HC6</b> , CORTEN/Brown Core <b>HC7</b> , DARK GREY/Black Core <b>HGW</b>  |
| <b>HH3</b> | ST WHITE/White Core <b>AB4</b> , ST SAND/Sand Core <b>ACR</b> , ST GRAPHITE GREY/ Grafite Core <b>AGD</b> , ST BLACK/Black Core <b>AN4</b> , ST TORTORA/Tortora Core <b>ATR</b> , ST RED NAMIB/Red Core <b>FAM</b> , ST YELLOW EVORA/Yellow Core <b>FGO</b> , ST RED BULGARO/Red Core <b>FRB</b> , ST GREEN KITAMI/Green Core <b>FKV</b> |

**Legs finishes**

**Metal**

|           |   |
|-----------|---|
| <b>MI</b> | WHITE <b>BB</b> , BROWN <b>E6</b> , SAND <b>EC</b> , WHITE PEARL <b>EF</b> , GRAPHITE <b>EG</b> , BLACK <b>EN</b> |
|-----------|---|

**Veneer**

|            |   |
|------------|---|
| <b>L11</b> | Stained NATURAL <b>I40</b> , Stained WHITENED <b>I60</b> , Stained DESERT <b>I61</b> , Stained LIGHT GREY <b>I62</b> , Stained DARK GREY <b>I63</b> |
|------------|---|

**Metal**

|           |  |
|-----------|--|
| <b>M1</b> | WHITE <b>BB</b> , BROWN <b>E6</b> , SAND <b>EC</b> , WHITE PEARL <b>EF</b> , GRAPHITE <b>EG</b> , BLACK <b>EN</b>  |
| <b>M2</b> | LIGHT BLUE <b>E0</b> , OCEAN BLUE <b>E1</b> , BRONZE <b>E2</b> , FANGO <b>E3</b> , PASTEL YELLOW <b>E4</b> , OCHER YELLOW <b>E7</b> , FACEPOWDER PINK <b>E8</b> , SAGE GREEN <b>E9</b> , PAPAYA ORANGE <b>EA</b> , BLUE SAPPHIRE <b>EE</b> , BLUE TURQUOISE <b>EH</b> , PINE GREEN <b>EJ</b> , DARK GREEN <b>EL</b> , GOLDEN YELLOW <b>EO</b> , CHERRY RED <b>EQ</b> , RED <b>ER</b> , ASH GREY <b>ES</b> , LIGHT GREY <b>ET</b> , BULGARO RED <b>FP</b> |

**Finishes Cable Management Box**

**Metal**

|           |              |
|-----------|--------------|
| <b>MI</b> | WHITE, BLACK |
|-----------|--------------|

**Optionals:**

|              |                      | Value   | Options/notes  |
|--------------|----------------------|---------|--|
| <b>FM-M2</b> | Indoor matt metal M2 | + 66 €  | ASH GREY <b>ES</b> , BLUE SAPPHIRE <b>EE</b> , BLUE TURQUOISE <b>EH</b> , BRONZE <b>E2</b> , BULGARO RED <b>FP</b> , CHERRY RED <b>EQ</b> , DARK GREEN <b>EL</b> , FACEPOWDER PINK <b>E8</b> , FANGO <b>E3</b> , GOLDEN YELLOW <b>EO</b> , LIGHT BLUE <b>E0</b> , LIGHT GREY <b>ET</b> , OCEAN BLUE <b>E1</b> , OCHER YELLOW <b>E7</b> , PAPAYA ORANGE <b>EA</b> , PASTEL YELLOW <b>E4</b> , PINE GREEN <b>EJ</b> , RED <b>ER</b> , SAGE GREEN <b>E9</b> |
| <b>ZZ-PC</b> | Cable management box | + 121 € | ZZ-PC  |

**140x 80**

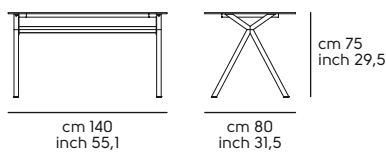

**160x 80**

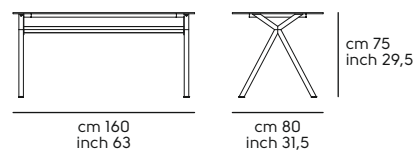

**200x100**

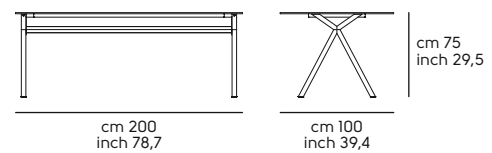

**140x 80 H.110**

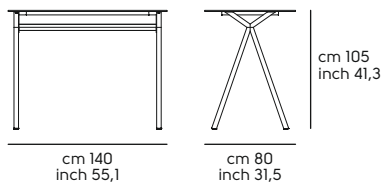

**160x 80 H.110**

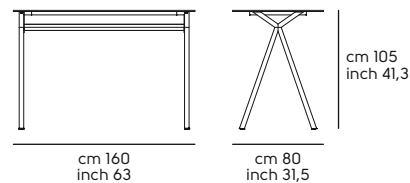

**200x100 H.110**

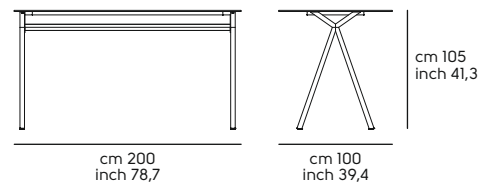

**Cable management box**

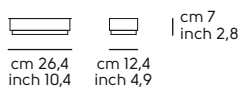

# Diamante design Studio Kappa

## Table Diamante

Frame in: metal



| Version | Code | Legs | Frame | Top | Optional | Q.ty | boxes | Kg | M <sup>3</sup> |
|---------|------|------|-------|-----|----------|------|-------|----|----------------|
|---------|------|------|-------|-----|----------|------|-------|----|----------------|

### Diamante Melamine HL

Top 18 mm. thk

|         |          |    |    | HL1     |       |   |   |      |      |
|---------|----------|----|----|---------|-------|---|---|------|------|
| 120x 80 | T0160012 |    |    | 845 €   |       | 1 | 3 | 38   | 0.20 |
| 140x 90 | T0160014 |    |    | 930 €   |       | 1 | 3 | 43.4 | 0.24 |
| 160x 90 | T0160016 | MI | MI | 1.050 € | FM-M2 | 1 | 3 | 44.7 | 0.25 |
| 180x 90 | T0160018 |    |    | 1.170 € |       | 1 | 3 | 51.5 | 0.29 |
| 180x100 | T0160019 |    |    | 1.290 € |       | 1 | 3 | 54   | 0.29 |

### Diamante MDF

Top 19 mm. thk

|         |          |    |    | LM1     |       |   |   |      |      |
|---------|----------|----|----|---------|-------|---|---|------|------|
| 120x 80 | T0160012 |    |    | 1.210 € |       | 1 | 3 | 38   | 0.20 |
| 140x 90 | T0160014 |    |    | 1.370 € |       | 1 | 3 | 43.4 | 0.24 |
| 160x 90 | T0160016 | MI | MI | 1.510 € | FM-M2 | 1 | 3 | 44.7 | 0.25 |
| 180x 90 | T0160018 |    |    | 1.710 € |       | 1 | 3 | 51.5 | 0.29 |
| 180x100 | T0160019 |    |    | 1.830 € |       | 1 | 3 | 54   | 0.29 |

### Diamante Veneer

Top 19 mm. thk

|         |          |    |    | LI1     | LI2     |       |   |   |      |      |
|---------|----------|----|----|---------|---------|-------|---|---|------|------|
| 120x 80 | T0160012 |    |    | 1.670 € | 1.810 € |       | 1 | 3 | 38   | 0.20 |
| 140x 90 | T0160014 |    |    | 1.840 € | 2.000 € |       | 1 | 3 | 43.4 | 0.24 |
| 160x 90 | T0160016 | MI | MI | 2.090 € | 2.350 € | FM-M2 | 1 | 3 | 44.7 | 0.25 |
| 180x 90 | T0160018 |    |    | 2.280 € | 2.610 € |       | 1 | 3 | 51.5 | 0.29 |
| 180x100 | T0160019 |    |    | 2.400 € | 2.730 € |       | 1 | 3 | 54   | 0.29 |

### Diamante HPL

Top 10 mm. thk

|         |          |    |    | HH1     | HH2     | HH3     |       |   |   |      |      |
|---------|----------|----|----|---------|---------|---------|-------|---|---|------|------|
| 120x 80 | T0160012 |    |    | 1.490 € | 1.560 € | 1.850 € |       | 1 | 3 | 38   | 0.20 |
| 140x 90 | T0160014 |    |    | 1.550 € | 1.630 € | 1.970 € |       | 1 | 3 | 43.4 | 0.24 |
| 160x 90 | T0160016 | MI | MI | 1.900 € | 2.050 € | 2.250 € | FM-M2 | 1 | 3 | 44.7 | 0.25 |
| 180x 90 | T0160018 |    |    | 2.080 € | 2.230 € | 2.410 € |       | 1 | 3 | 51.5 | 0.29 |
| 180x100 | T0160019 |    |    | 2.200 € | 2.350 € | 3.530 € |       | 1 | 3 | 54   | 0.29 |

**Diamante Glass**

Top 10 mm. thk

|         |          |    |    | GVB     | GVC     | GVD     |       |   |   |      |      |
|---------|----------|----|----|---------|---------|---------|-------|---|---|------|------|
| 120x 80 | T0160012 | M1 | M1 | 1.170 € | 1.320 € | 1.390 € | FM-M2 | 1 | 3 | 59   | 0.20 |
| 140x 90 | T0160014 |    |    | 1.340 € | 1.480 € | 1.600 € |       | 1 | 3 | 68   | 0.24 |
| 160x 90 | T0160016 | M1 | M1 | 1.510 € | 1.670 € | 1.840 € | FM-M2 | 1 | 3 | 76.7 | 0.25 |
| 180x 90 | T0160018 |    |    | 1.680 € | 1.790 € | 2.050 € |       | 1 | 3 | 81.5 | 0.29 |
| 180x100 | T0160019 |    |    | 1.800 € | 1.910 € | 2.170 € |       | 1 | 3 | 89   | 0.29 |

**Diamante Ceramic**

Top 14 mm. thk

|         |          |    |    | GKA     | GKB     | GMA     |       |   |   |      |      |
|---------|----------|----|----|---------|---------|---------|-------|---|---|------|------|
| 120x 80 | T0160012 |    |    | 1.470 € | 1.540 € | 1.750 € |       | 1 | 3 | 68   | 0.20 |
| 140x 90 | T0160014 |    |    | 1.740 € | 1.810 € | 2.010 € |       | 1 | 3 | 79.4 | 0.24 |
| 160x 90 | T0160016 | M1 | M1 | 1.940 € | 2.010 € | 2.180 € | FM-M2 | 1 | 3 | 89.7 | 0.25 |
| 180x 90 | T0160018 |    |    | 2.100 € | 2.170 € | 2.510 € |       | 1 | 3 | 96.5 | 0.29 |
| 180x100 | T0160019 |    |    | 2.220 € | 2.290 € | 2.630 € |       | 1 | 3 | 105  | 0.29 |

| Version | Code | Legs | Frame | Top and extensions |  |  | Optional | Q.ty | boxes | Kg | M <sup>3</sup> |
|---------|------|------|-------|--------------------|--|--|----------|------|-------|----|----------------|
|---------|------|------|-------|--------------------|--|--|----------|------|-------|----|----------------|

**Diamante Melamine HL**

Top and extensions 18 mm thk

|                     |          |    |    | HLI     |  |  |       |   |   |      |      |
|---------------------|----------|----|----|---------|--|--|-------|---|---|------|------|
| 120/170x 80         | T0160121 | M1 | M1 | 1.195 € |  |  | FM-M2 | 1 | 4 | 50   | 0.23 |
| 140/200x 90         | T0160141 |    |    | 1.301 € |  |  |       | 1 | 4 | 51.4 | 0.28 |
| 140/190/240x 90     | T0160142 |    |    | 1.410 € |  |  |       | 1 | 5 | 59.4 | 0.30 |
| 140/190/240/290x 90 | T0160143 |    |    | 1.796 € |  |  |       | 1 | 6 | 67.4 | 0.33 |
| 160/220x 90         | T0160159 |    |    | 1.430 € |  |  |       | 1 | 4 | 52.7 | 0.29 |
| 160/210/260x 90     | T0160162 |    |    | 1.760 € |  |  |       | 1 | 5 | 60.7 | 0.31 |
| 160/210/260/310x 90 | T0160161 |    |    | 1.870 € |  |  |       | 1 | 6 | 68.7 | 0.34 |
| 180/240x 90         | T0160180 |    |    | 1.610 € |  |  |       | 1 | 4 | 59.5 | 0.34 |
| 180/230/280x 90     | T0160182 |    |    | 1.800 € |  |  |       | 1 | 5 | 67.5 | 0.36 |
| 180/240x100         | T0160185 |    |    | 1.720 € |  |  |       | 1 | 4 | 62   | 0.35 |
| 180/230/280x100     | T0160186 |    |    | 1.910 € |  |  |       | 1 | 5 | 70   | 0.38 |

**Diamante MDF**

Top and extensions 19 mm thk

|                     |          |    |    | LMI     |  |  |       |   |   |      |      |
|---------------------|----------|----|----|---------|--|--|-------|---|---|------|------|
| 120/170x 80         | T0160121 | M1 | M1 | 1.290 € |  |  | FM-M2 | 1 | 4 | 50   | 0.23 |
| 140/200x 90         | T0160141 |    |    | 1.743 € |  |  |       | 1 | 4 | 51.4 | 0.28 |
| 140/190/240x 90     | T0160142 |    |    | 1.810 € |  |  |       | 1 | 5 | 59.4 | 0.30 |
| 140/190/240/290x 90 | T0160143 |    |    | 2.095 € |  |  |       | 1 | 6 | 67.4 | 0.33 |
| 160/220x 90         | T0160159 |    |    | 1.870 € |  |  |       | 1 | 4 | 52.7 | 0.29 |
| 160/210/260 x90     | T0160162 |    |    | 1.961 € |  |  |       | 1 | 5 | 60.7 | 0.31 |
| 160/210/260/310x 90 | T0160161 |    |    | 2.308 € |  |  |       | 1 | 6 | 68.7 | 0.34 |
| 180/240x 90         | T0160180 |    |    | 2.170 € |  |  |       | 1 | 4 | 59.5 | 0.34 |
| 180/230/280x 90     | T0160182 |    |    | 2.350 € |  |  |       | 1 | 5 | 67.5 | 0.36 |
| 180/240x100         | T0160185 |    |    | 2.280 € |  |  |       | 1 | 4 | 62   | 0.35 |
| 180/230/280x100     | T0160186 |    |    | 2.460 € |  |  |       | 1 | 5 | 70   | 0.38 |

**Diamante Veneer**

Top and extensions 19 mm thk

|                     |          |    |    | L11     | L12     |       |   |   |      |      |
|---------------------|----------|----|----|---------|---------|-------|---|---|------|------|
| 120/170x 80         | T0160121 |    |    | 1.900 € | 2.210 € |       | 1 | 4 | 50   | 0.23 |
| 140/200x 90         | T0160141 |    |    | 2.210 € | 2.610 € |       | 1 | 4 | 51.4 | 0.28 |
| 140/190/240x 90     | T0160142 |    |    | 2.610 € | 3.010 € |       | 1 | 5 | 59.4 | 0.30 |
| 140/190/240/290x 90 | T0160143 | MI | MI | 2.790 € | 3.210 € | FM-M2 | 1 | 6 | 67.4 | 0.33 |
| 160/220x 90         | T0160159 |    |    | 2.400 € | 2.810 € |       | 1 | 4 | 52.7 | 0.29 |
| 160/210/260 x90     | T0160162 |    |    | 2.690 € | 3.110 € |       | 1 | 5 | 60.7 | 0.31 |
| 160/210/260/310x 90 | T0160161 |    |    | 2.890 € | 3.410 € |       | 1 | 6 | 68.7 | 0.34 |
| 180/240x 90         | T0160180 |    |    | 2.810 € | 3.270 € |       | 1 | 4 | 59.5 | 0.34 |
| 180/230/280x 90     | T0160182 |    |    | 3.200 € | 3.670 € |       | 1 | 5 | 67.5 | 0.36 |
| 180/240x100         | T0160185 | MI | MI | 2.920 € | 3.380 € | FM-M2 | 1 | 4 | 62   | 0.35 |
| 180/230/280x100     | T0160186 |    |    | 3.310 € | 3.780 € |       | 1 | 5 | 70   | 0.38 |

**Diamante HPL**

Top and extensions 10 mm thk

|                     |          |    |    | HH1     | HH2     | HH3     |       |   |   |      |      |
|---------------------|----------|----|----|---------|---------|---------|-------|---|---|------|------|
| 120/170x 80         | T0160121 |    |    | 1.840 € | 1.870 € | 2.070 € |       | 1 | 4 | 50   | 0.23 |
| 140/200x 90         | T0160141 |    |    | 2.080 € | 2.110 € | 2.330 € |       | 1 | 4 | 51.4 | 0.28 |
| 140/190/240x 90     | T0160142 |    |    | 2.350 € | 2.390 € | 2.700 € |       | 1 | 5 | 59.4 | 0.30 |
| 140/190/240/290x 90 | T0160143 |    |    | 2.530 € | 2.570 € | 3.100 € |       | 1 | 6 | 67.4 | 0.33 |
| 160/220x 90         | T0160159 |    |    | 2.400 € | 2.440 € | 2.610 € |       | 1 | 4 | 52.7 | 0.29 |
| 160/210/260 x90     | T0160162 | MI | MI | 2.630 € | 2.700 € | 3.030 € | FM-M2 | 1 | 5 | 60.7 | 0.31 |
| 160/210/260/310x 90 | T0160161 |    |    | 2.870 € | 2.930 € | 3.410 € |       | 1 | 6 | 68.7 | 0.34 |
| 180/240x 90         | T0160180 |    |    | 2.500 € | 2.560 € | 2.915 € |       | 1 | 4 | 59.5 | 0.34 |
| 180/230/280x 90     | T0160182 |    |    | 2.710 € | 2.770 € | 3.210 € |       | 1 | 5 | 67.5 | 0.36 |
| 180/240x100         | T0160185 |    |    | 2.610 € | 2.670 € | 3.025 € |       | 1 | 4 | 62   | 0.35 |
| 180/230/280x100     | T0160186 |    |    | 2.820 € | 2.880 € | 3.320 € |       | 1 | 5 | 70   | 0.38 |

**Diamante Glass**

Glass top 10 mm thk MDF extensions 19 mm thk

|                     |          |    |    | GVB     | GVC     | GVD     |       |   |   |       |      |
|---------------------|----------|----|----|---------|---------|---------|-------|---|---|-------|------|
| 120/170 x80         | T0160121 |    |    | 1.414 € | 1.598 € | 1.741 € |       | 1 | 4 | 64.8  | 0.23 |
| 140/200x 90         | T0160141 |    |    | 1.495 € | 1.690 € | 1.820 € |       | 1 | 4 | 76    | 0.28 |
| 140/190/240x 90     | T0160142 |    |    | 1.990 € | 2.080 € | 2.160 € |       | 1 | 5 | 84    | 0.30 |
| 140/190/240/290x 90 | T0160143 |    |    | 2.352 € | 2.533 € | 2.757 € |       | 1 | 6 | 92    | 0.33 |
| 160/220x 90         | T0160159 |    |    | 1.910 € | 2.010 € | 2.160 € |       | 1 | 4 | 84.7  | 0.29 |
| 160/210/260 x90     | T0160162 | MI | MI | 1.768 € | 1.956 € | 2.087 € | FM-M2 | 1 | 5 | 93    | 0.31 |
| 160/210/260/310x 90 | T0160161 |    |    | 2.490 € | 2.663 € | 2.926 € |       | 1 | 6 | 100.7 | 0.34 |
| 180/240x 90         | T0160180 |    |    | 1.960 € | 2.050 € | 2.250 € |       | 1 | 4 | 89.5  | 0.34 |
| 180/230/280x 90     | T0160182 |    |    | 2.070 € | 2.170 € | 2.370 € |       | 1 | 5 | 97.5  | 0.36 |
| 180/240x100         | T0160185 |    |    | 2.038 € | 2.132 € | 2.340 € |       | 1 | 4 | 97    | 0.35 |
| 180/230/280x100     | T0160186 |    |    | 2.153 € | 2.257 € | 2.465 € |       | 1 | 5 | 105   | 0.38 |

**Diamante Ceramic**

Ceramic top 14 mm thk MDF extensions 22 mm thk

|                     |          |    |    | GKA     | GKB     | GMA     |       |   |   |       |      |
|---------------------|----------|----|----|---------|---------|---------|-------|---|---|-------|------|
| 120/170 x80         | T0160121 |    |    | 1.928 € | 2.057 € | 2.266 € |       | 1 | 4 | 74    | 0.23 |
| 140/200x 90         | T0160141 |    |    | 1.999 € | 2.160 € | 2.390 € |       | 1 | 4 | 87.4  | 0.28 |
| 140/190/240x 90     | T0160142 |    |    | 2.310 € | 2.390 € | 2.770 € |       | 1 | 5 | 95.4  | 0.30 |
| 140/190/240/290x 90 | T0160143 |    |    | 2.854 € | 3.078 € | 3.362 € |       | 1 | 6 | 103.4 | 0.33 |
| 160/220x 90         | T0160159 |    |    | 2.300 € | 2.350 € | 2.850 € |       | 1 | 4 | 97.7  | 0.29 |
| 160/210/260 x90     | T0160162 | M1 | M1 | 2.432 € | 2.661 € | 2.927 € | FM-M2 | 1 | 5 | 105.7 | 0.31 |
| 160/210/260/310x 90 | T0160161 |    |    | 3.076 € | 3.178 € | 3.453 € |       | 1 | 6 | 113.7 | 0.34 |
| 180/240x 90         | T0160180 |    |    | 2.330 € | 2.380 € | 2.870 € |       | 1 | 4 | 104.5 | 0.34 |
| 180/230/280x 90     | T0160182 |    |    | 2.440 € | 2.500 € | 2.990 € |       | 1 | 5 | 112.5 | 0.36 |
| 180/240x100         | T0160185 |    |    | 2.423 € | 2.475 € | 2.985 € |       | 1 | 4 | 113   | 0.35 |
| 180/230/280x100     | T0160186 |    |    | 2.538 € | 2.600 € | 3.110 € |       | 1 | 5 | 121   | 0.38 |

**Diamante Ceramic + extensions HPL**

Ceramic top 14 mm thk HPL extensions

|                     |          |    |    | GKA     | GKB     | GMA     |       |   |   |       |      |
|---------------------|----------|----|----|---------|---------|---------|-------|---|---|-------|------|
| 120/170 x80         | T0168120 | M1 | M1 | 2.118 € | 2.247 € | 2.456 € | FM-M2 | 1 | 4 | 74    | 0.23 |
| 140/200x 90         | T0168141 |    |    | 2.268 € | 2.418 € | 2.640 € |       | 1 | 4 | 87.4  | 0.28 |
| 140/190/240x 90     | T0168142 |    |    | 2.700 € | 2.780 € | 3.100 € |       | 1 | 5 | 95.4  | 0.30 |
| 140/190/240/290x 90 | T0168143 |    |    | 3.350 € | 3.500 € | 3.720 € |       | 1 | 6 | 103.4 | 0.33 |
| 160/220x 90         | T0168159 |    |    | 2.590 € | 2.640 € | 3.040 € |       | 1 | 4 | 97.7  | 0.29 |
| 160/210/260 x90     | T0168160 |    |    | 2.822 € | 3.051 € | 3.317 € |       | 1 | 5 | 105.7 | 0.31 |
| 160/210/260/310x 90 | T0168161 | M1 | M1 | 3.560 € | 3.668 € | 3.940 € | FM-M2 | 1 | 6 | 113.7 | 0.34 |
| 180/240x 90         | T0168180 |    |    | 2.800 € | 2.900 € | 3.190 € |       | 1 | 4 | 104.5 | 0.34 |
| 180/230/280x 90     | T0168182 |    |    | 3.400 € | 3.490 € | 3.715 € |       | 1 | 5 | 112.5 | 0.36 |
| 180/240x100         | T0168185 |    |    | 2.930 € | 3.030 € | 3.320 € |       | 1 | 4 | 113   | 0.35 |
| 180/230/280x100     | T0168186 |    |    | 3.450 € | 3.630 € | 3.855 € |       | 1 | 5 | 121   | 0.38 |

**Note:**

For Glass or Crystal Ceramic tops, extensions Only in MDF or HPL - Table 180x100 NO Ceramic K26

**Frame finishes**

**Metal**

|           |   |
|-----------|---|
| <b>MI</b> | WHITE <b>BB</b> , BROWN <b>E6</b> , SAND <b>EC</b> , WHITE PEARL <b>EF</b> , GRAPHITE <b>EG</b> , BLACK <b>EN</b> |
|-----------|---|

**Legs finishes**

**Metal**

|           |   |
|-----------|---|
| <b>MI</b> | WHITE <b>BB</b> , BROWN <b>E6</b> , SAND <b>EC</b> , WHITE PEARL <b>EF</b> , GRAPHITE <b>EG</b> , BLACK <b>EN</b> |
|-----------|---|

**Top and extensions finishes**

**Melamine**

|            |  |
|------------|--|
| <b>HL1</b> | WHITE <b>M01</b> , GRAFITE <b>M02</b> , BLACK <b>M04</b> , SAND <b>M07</b> |
|------------|--|

**Veneer**

|            |  |
|------------|--|
| <b>L11</b> | Stained BLACK <b>I04</b> , Stained WHITE <b>I05</b> , Stained CHERRY RED <b>I09</b> , Stained DARK BROWN <b>I26</b> , Stained NATURAL <b>I40</b> , Stained NATURAL OAK <b>I52</b> , Stained WHITENED <b>I60</b> , Stained DESERT <b>I61</b> , Stained LIGHT GREY <b>I62</b> , Stained DARK GREY <b>I63</b> |
| <b>L12</b> | NATURAL OAK <b>I22</b> , FLAMED WALNUT <b>I24</b>  |

**Lacquered MDF**

|            |   |
|------------|---|
| <b>LMI</b> | GRAPHITE GREY <b>G02</b> , BLACK <b>G04</b> , WHITE <b>G05</b> , SAND <b>G07</b> , BROWN <b>G41</b> |
|------------|---|

**HPL**

|            |  |
|------------|--|
| <b>HH1</b> | WHITE/Black Core <b>HB4</b> , BLACK/Black Core <b>HN4</b>  |
| <b>HH2</b> | CEMENT/Black Core <b>HC6</b> , CORTEN/Brown Core <b>HC7</b> , DARK GREY/Black Core <b>HGW</b>  |
| <b>HH3</b> | ST WHITE/White Core <b>AB4</b> , ST SAND/Sand Core <b>ACR</b> , ST GRAPHITE GREY/ Grafite Core <b>AGD</b> , ST BLACK/Black Core <b>AN4</b> , ST TORTORA/Tortora Core <b>ATR</b> , ST RED NAMIB/Red Core <b>FAM</b> , ST YELLOW EVORA/Yellow Core <b>FGO</b> , ST RED BULGARO/Red Core <b>FRB</b> , ST GREEN KITAMI/Green Core <b>FVK</b> |

**Top finishes**

**Glass**

|            |   |
|------------|---|
| <b>GVC</b> | MATT GRAFITE ANTISCRATCH <b>J31</b> , MATT SAND ANTISCRATCH <b>J32</b>  |
| <b>GVD</b> | EXTRA CLEAR MATT WHITE ANTISCRATCH <b>J41</b>   |
| <b>GVB</b> | EXTRA CLEAR GLOSSY WHITE <b>J21</b> , EXTRA CLEAR GLOSSY CHERRY RED <b>J25</b> , EXTRA CLEAR GLOSSY BLUE SAPPHIRE <b>J26</b> , EXTRA CLEAR GLOSSY BLUE TURQUOISE <b>J27</b> |

**Crystal Ceramic and Ceramic**

|            |   |
|------------|---|
| <b>GKA</b> | CHARCOAL SAVOIA <b>K11</b> , CEMENT SAVOIA <b>K12</b>   |
| <b>GKB</b> | WHITE CALCE <b>K24</b> , BLACK CALCE <b>K25</b> , TORTORA CALCE <b>K26</b> , PIASENTINA STONE TAUPE Materica <b>K55</b> , TERRACOTTA Matt <b>K90</b> , MATT GREEN <b>K91</b>  |
| <b>GMA</b> | MARBLE CALACATTA GLOSSY WHITE <b>K32</b> , BLACK GREEK MARBLE <b>K33</b> , MARBLE GLOSSY NOIR DESIR <b>K35</b> , MARBLE CALACATTA MATT WHITE <b>K42</b> , MARBLE MATT NOIR DESIR <b>K45</b> , MARBLE MATT GREEN TINOS <b>K46</b> , MARBLE STATUARIO WHITE MATT <b>K47</b> , MARBLE CALACAT BLACK Bush Hammered <b>K50</b> |

**Optionals:**

|              | Value   | Options/notes  |
|--------------|---------|--|
| <b>FM-M2</b> | + 180 € | ASH GREY <b>ES</b> , BLUE SAPPHIRE <b>EE</b> , BLUE TURQUOISE <b>EH</b> , BRONZE <b>E2</b> , BULGARO RED <b>FP</b> , CHERRY RED <b>EQ</b> , DARK GREEN <b>EL</b> , FACEPOWDER PINK <b>E8</b> , FANGO <b>E3</b> , GOLDEN YELLOW <b>EO</b> , LIGHT BLUE <b>EO</b> , LIGHT GREY <b>ET</b> , OCEAN BLUE <b>E1</b> , OCHER YELLOW <b>E7</b> , PAPAYA ORANGE <b>EA</b> , PASTEL YELLOW <b>E4</b> , PINE GREEN <b>EJ</b> , RED <b>ER</b> , SAGE GREEN <b>E9</b> |

**120x 80**

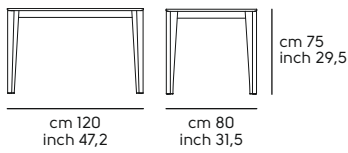

**140x 90**

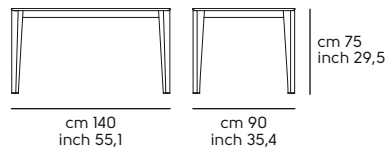

**160x 90**

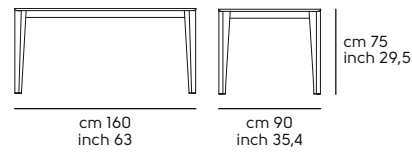

**180x 90**

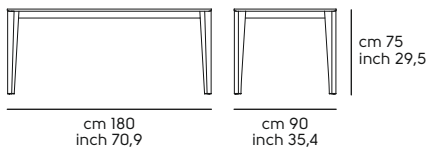

**180x100**

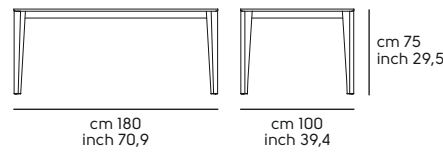

**120/170x 80**

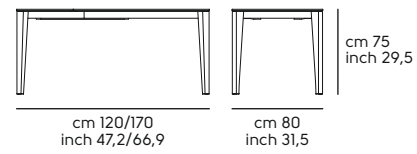

**140/200x 90**

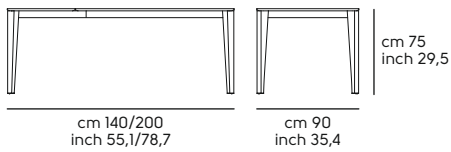

**140/190/240x 90**

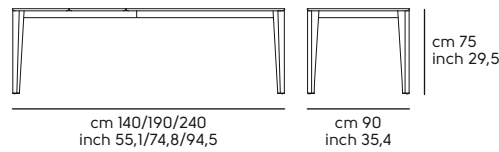

**140/190/240/290x 90**

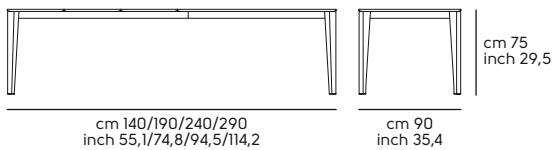

**160/220x 90**

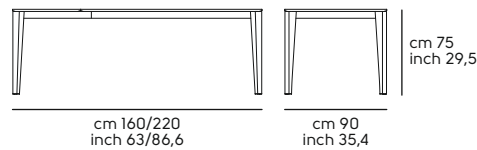

**160/210/260 x90**

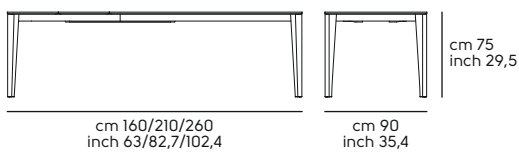

**160/210/260/310x 90**

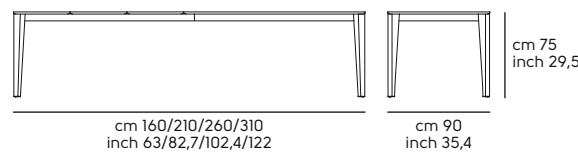

**180/240x 90**

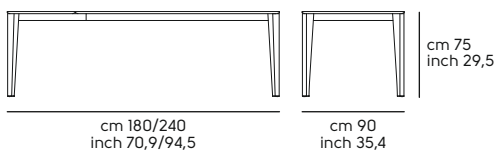

**180/230/280x 90**

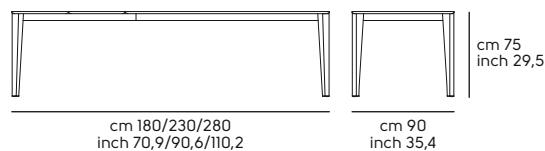

**180/240x100**

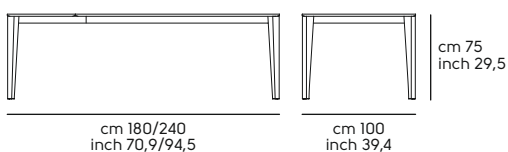

**180/230/280x100**

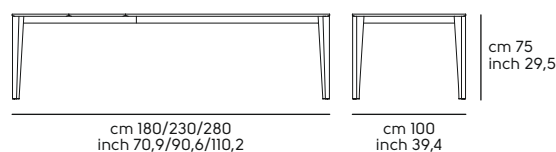

# Eggen design StudioPANG

## Table Eggen

Legs and Top: Veneer



| Version | Code | -- | -- | Legs and Top | Optional | Q.ty | boxes | Kg | M <sup>3</sup> |
|---------|------|----|----|--------------|----------|------|-------|----|----------------|
|---------|------|----|----|--------------|----------|------|-------|----|----------------|

### Eggen Veneer

Top 45 mm. thk

|         |          |  |  | LI1     | LI2     |  |   |   |     |      |
|---------|----------|--|--|---------|---------|--|---|---|-----|------|
| 250x120 | T2310250 |  |  | 5.280 € | 5.930 € |  | 1 | 3 | 200 | 0.93 |
| 300x120 | T2310300 |  |  | 5.990 € | 6.450 € |  | 1 | 3 | 240 | 1.05 |

### Top finishes

#### Veneer

|            |  |
|------------|--|
| <b>LI1</b> | Stained BLACK <b>I04</b> , Stained NATURAL <b>I40</b> , Stained WHITENED <b>I60</b> , Stained DESERT <b>I61</b> , Stained LIGHT GREY <b>I62</b> , Stained DARK GREY <b>I63</b> |
| <b>LI2</b> | NATURAL OAK <b>I22</b> , FLAMED WALNUT <b>I24</b>  |

### Legs finishes

#### Veneer

|            |  |
|------------|--|
| <b>LI1</b> | Veneered wood painted BLACK <b>I04</b> , Veneered wood painted NATURAL <b>I40</b> , Veneered wood painted WHITENED <b>I60</b> , Veneered wood painted DESERT <b>I61</b> , Veneered wood painted LIGHT GREY <b>I62</b> , Veneered wood painted DARK GREY <b>I63</b> |
| <b>LI2</b> | Veneered wood NATURAL OAK <b>I22</b> , Veneered wood FLAMED WALNUT <b>I24</b>  |

### 250x120

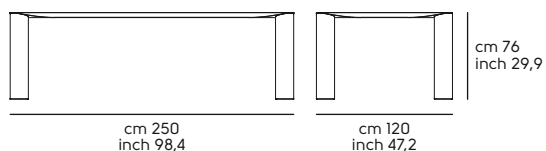

### 300x120

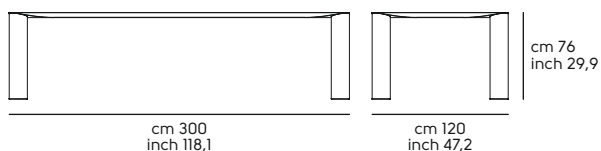

# Foil design Giovanni Crosera

## Table Foil

Frame in: metal



| Version | Code | Legs | Frame | Top | Optional | Q.ty | boxes | Kg | M <sup>3</sup> |
|---------|------|------|-------|-----|----------|------|-------|----|----------------|
|---------|------|------|-------|-----|----------|------|-------|----|----------------|

### Foil Veneer

Top 20 mm. thk

|                |           |    |    | L11     | L12     |       |   |   |     |      |
|----------------|-----------|----|----|---------|---------|-------|---|---|-----|------|
| D.150          | T23900150 |    |    | 2.920 € | 3.150 € |       | 1 | 4 | 88  | 0.51 |
| 220x110 Barrel | T23902211 |    |    | 3.320 € | 3.505 € |       | 1 | 4 | 104 | 0.59 |
| 250x110 Barrel | T23902511 | MI | MI | 3.920 € | 4.090 € | FM-M2 | 1 | 4 | 108 | 0.62 |
| 280x120 Barrel | T23902812 |    |    | 4.740 € | 4.860 € |       | 1 | 5 | 146 | 0.80 |
| 300x120 Barrel | T23903012 |    |    | 4.980 € | 5.170 € |       | 1 | 5 | 150 | 0.84 |

| Version | Code | Legs | Frame | Top | Optional | Q.ty | boxes | Kg | M <sup>3</sup> |
|---------|------|------|-------|-----|----------|------|-------|----|----------------|
|---------|------|------|-------|-----|----------|------|-------|----|----------------|

### Foil Glass

Top 12 mm. thk

|                |           |    |    | GVB     | GVC     | GVD     |       |   |   |     |      |
|----------------|-----------|----|----|---------|---------|---------|-------|---|---|-----|------|
| D.150          | T23900150 |    |    | 2.850 € | 2.880 € | 2.910 € |       | 1 | 4 | 131 | 0.61 |
| 220x110 Barrel | T23902211 |    |    | 3.020 € | 3.060 € | 3.095 € |       | 1 | 4 | 165 | 0.70 |
| 250x110 Barrel | T23902511 | MI | MI | 3.190 € | 3.220 € | 3.260 € | FM-M2 | 1 | 4 | 175 | 0.74 |
| 280x120 Barrel | T23902812 |    |    | 4.090 € | 4.150 € | 4.210 € |       | 1 | 5 | 230 | 0.96 |
| 300x120 Barrel | T23903012 |    |    | 4.210 € | 4.270 € | 4.320 € |       | 1 | 5 | 237 | 1.00 |

| Version | Code | Legs | Frame | Top | Optional | Q.ty | boxes | Kg | M <sup>3</sup> |
|---------|------|------|-------|-----|----------|------|-------|----|----------------|
|---------|------|------|-------|-----|----------|------|-------|----|----------------|

### Foil Ceramic

Top 12 mm. thk

|                |           |    |    | GKA     | GKB     | GMA     |       |   |   |     |      |
|----------------|-----------|----|----|---------|---------|---------|-------|---|---|-----|------|
| D.150          | T23900150 |    |    | 3.150 € | 3.450 € | 3.480 € |       | 1 | 4 | 126 | 0.61 |
| 220x110 Barrel | T23902211 |    |    | 3.950 € | 4.370 € | 4.660 € |       | 1 | 4 | 157 | 0.70 |
| 250x110 Barrel | T23902511 | MI | MI | 4.070 € | 4.490 € | 4.845 € | FM-M2 | 1 | 4 | 166 | 0.74 |
| 280x120 Barrel | T23902812 |    |    | 4.840 € | 5.290 € | 5.615 € |       | 1 | 5 | 210 | 0.96 |
| 300x120 Barrel | T23903012 |    |    | 4.920 € | 5.390 € | 5.790 € |       | 1 | 5 | 226 | 1.00 |

| Version | Code | Legs | Frame | Top | Optional | Q.ty | boxes | Kg | M <sup>3</sup> |
|---------|------|------|-------|-----|----------|------|-------|----|----------------|
|---------|------|------|-------|-----|----------|------|-------|----|----------------|

### Foil Marble

Top 20 mm. thk

|                |           |    |    | GMM     |  |       |   |   |     |      |
|----------------|-----------|----|----|---------|--|-------|---|---|-----|------|
| D.150          | T23900150 |    |    | 4.890 € |  |       | 1 | 4 | 170 | 0.61 |
| 220x110 Barrel | T23902211 |    |    | 4.980 € |  |       | 1 | 4 | 218 | 0.70 |
| 250x110 Barrel | T23902511 | MI | MI | 5.240 € |  | FM-M2 | 1 | 4 | 235 | 0.74 |
| 280x120 Barrel | T23902812 |    |    | 6.270 € |  |       | 1 | 5 | 304 | 0.96 |

**Frame finishes**

**Metal**

|           |   |
|-----------|---|
| <b>MI</b> | WHITE <b>BB</b> , BROWN <b>E6</b> , SAND <b>EC</b> , WHITE PEARL <b>EF</b> , GRAPHITE <b>EG</b> , BLACK <b>EN</b> |
|-----------|---|

**Top finishes**

**Veneer**

|            |   |
|------------|---|
| <b>LI1</b> | Stained BLACK <b>I04</b> , Stained WHITE <b>I05</b> , Stained NATURAL <b>I40</b> , Stained WHITENED <b>I60</b> , Stained DESERT <b>I61</b> , Stained LIGHT GREY <b>I62</b> , Stained DARK GREY <b>I63</b> |
| <b>LI2</b> | NATURAL OAK <b>I22</b> , FLAMED WALNUT <b>I24</b>   |

**Ceramic**

|            |  |
|------------|--|
| <b>GKA</b> | CHARCOAL SAVOIA <b>K11</b> , CEMENT SAVOIA <b>K12</b>  |
| <b>GKB</b> | WHITE CALCE <b>K24</b> , BLACK CALCE <b>K25</b> , TORTORA CALCE <b>K26</b> , PIASENTINA STONE TAUPE Materica <b>K55</b>  |
| <b>GMA</b> | MARBLE CALACATTA GLOSSY WHITE <b>K32</b> , BLACK GREEK MARBLE <b>K33</b> , MARBLE GLOSSY NOIR DESIR <b>K35</b> , MARBLE MATT NOIR DESIR <b>K45</b> , MARBLE MATT GREEN TINOS <b>K46</b> , MARBLE STATUARIO WHITE MATT <b>K47</b> , MARBLE CALACAT BLACK Bush Hammered <b>K50</b> |

**Legs finishes**

**Metal**

|           |   |
|-----------|---|
| <b>MI</b> | WHITE <b>BB</b> , BROWN <b>E6</b> , SAND <b>EC</b> , WHITE PEARL <b>EF</b> , GRAPHITE <b>EG</b> , BLACK <b>EN</b> |
|-----------|---|

**Glass**

|            |   |
|------------|---|
| <b>GVB</b> | EXTRA CLEAR GLOSSY CHERRY RED <b>J25</b> , EXTRA CLEAR GLOSSY BLUE SAPPHIRE <b>J26</b> , EXTRA CLEAR GLOSSY BLUE TURQUOISE <b>J27</b> |
| <b>GVC</b> | MATT GRAFITE ANTISCRATCH <b>J31</b> , MATT SAND ANTISCRATCH <b>J32</b>  |
| <b>GVD</b> | EXTRA CLEAR MATT WHITE ANTISCRATCH <b>J41</b>   |

**Marble**

|            |   |
|------------|---|
| <b>GMM</b> | BEIGE TRAVERTINO ROMANO <b>MB2</b> , WHITE CALACATTA VAGLI <b>MB4</b> , BLACK MARQUINIA <b>MN4</b> , GREEN TINOS <b>MVE</b> |
|------------|---|

**Optionals:**

|              |                      | Value   | Options/notes   |
|--------------|----------------------|---------|---|
| <b>FM-M2</b> | Indoor matt metal M2 | + 180 € | ASH GREY <b>ES</b> , BLUE SAPPHIRE <b>EE</b> , BLUE TURQUOISE <b>EH</b> , BRONZE <b>EZ</b> + TRANSP., BULGARO RED <b>FP</b> , CHERRY RED <b>EQ</b> , DARK GREEN <b>EL</b> , FACEPOWDER PINK <b>E8</b> , FANGO <b>E3</b> , GOLDEN YELLOW <b>EO</b> , LIGHT BLUE <b>EO</b> , LIGHT GREY <b>ET</b> , OCEAN BLUE <b>EI</b> , OCHER YELLOW <b>E7</b> , PAPAYA ORANGE <b>EA</b> , PASTEL YELLOW <b>E4</b> , PINE GREEN <b>EJ</b> , RED <b>ER</b> , SAGE GREEN <b>E9</b> |

**D. 150**

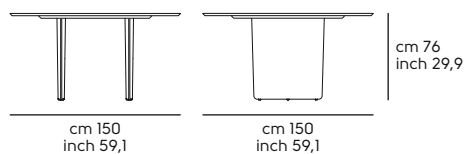

**220x110 Barrel**

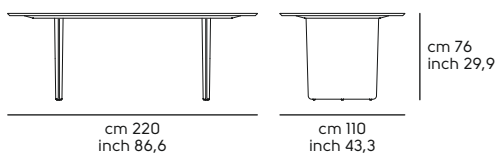

**250x110 Barrel**

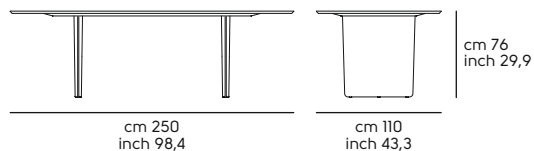

**280x120 Barrel**

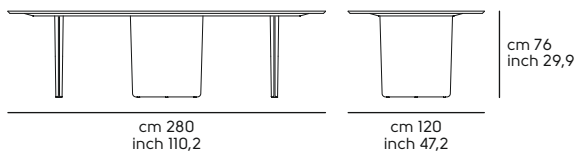

**300x120 Barrel**

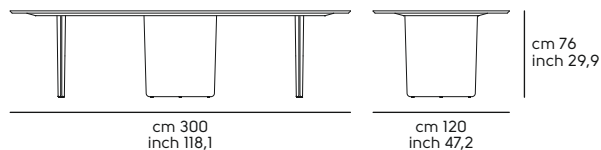

# Fold design Paolo Vernier

## Table Fold

Frame and top in: metal



| Version | Code | Legs | -- | Top | Optional | Q.ty | boxes | Kg | M <sup>3</sup> |
|---------|------|------|----|-----|----------|------|-------|----|----------------|
|---------|------|------|----|-----|----------|------|-------|----|----------------|

### Fold Metal

Top 17 mm. thk

|         |           |    |  | M1    | M2    |  |   |   |       |      |
|---------|-----------|----|--|-------|-------|--|---|---|-------|------|
| 70x70   | T2330Q070 |    |  | 359 € | 421 € |  | 1 | 2 | 22.50 | 0.15 |
| 80x80   | T2330Q080 |    |  | 369 € | 432 € |  | 1 | 2 | 25.5  | 0.17 |
| 90x90   | T2330Q090 | M1 |  | 426 € | 489 € |  | 1 | 2 | 28.5  | 0.19 |
| 100x100 | T2330Q100 |    |  | 540 € | 602 € |  | 1 | 2 | 32.5  | 0.22 |
| 120x80  | T2330R120 |    |  | 469 € | 531 € |  | 1 | 2 | 30.5  | 0.21 |

| Version | Code | Legs | -- | Top | Optional | Q.ty | boxes | Kg | M <sup>3</sup> |
|---------|------|------|----|-----|----------|------|-------|----|----------------|
|---------|------|------|----|-----|----------|------|-------|----|----------------|

### Fold INOX

Top 17 mm. thk

|         |           |    |  | M1    | M2    |  |   |   |       |      |
|---------|-----------|----|--|-------|-------|--|---|---|-------|------|
| 70x70   | T2331Q070 |    |  | 525 € | 588 € |  | 1 | 2 | 22.50 | 0.15 |
| 80x80   | T2331Q080 |    |  | 546 € | 608 € |  | 1 | 2 | 25.5  | 0.17 |
| 90x90   | T2331Q090 | M1 |  | 624 € | 686 € |  | 1 | 2 | 28.5  | 0.19 |
| 100x100 | T2331Q100 |    |  | 769 € | 831 € |  | 1 | 2 | 32.5  | 0.22 |
| 120x80  | T2331R120 |    |  | 677 € | 739 € |  | 1 | 2 | 30.5  | 0.21 |

### Note:

Metal M2 TRANSPARENT MATT [EW] only for Fold INOX

## Legs and Top finishes

### Metal

|           |   |
|-----------|---|
| <b>M1</b> | WHITE <b>BB</b> , BROWN <b>E6</b> , SAND <b>EC</b> , WHITE PEARL <b>EF</b> , GRAPHITE <b>EG</b> , BLACK <b>EN</b>   |
| <b>M2</b> | LIGHT BLUE <b>E0</b> , OCEAN BLUE <b>E1</b> , BRONZE <b>E2</b> , FANGO <b>E3</b> , PASTEL YELLOW <b>E4</b> , OCHER YELLOW <b>E7</b> , FACEPOWDER PINK <b>E8</b> , SAGE GREEN <b>E9</b> , PAPAYA ORANGE <b>EA</b> , BLUE SAPPHIRE <b>EE</b> , BLUE TURQUOISE <b>EH</b> , PINE GREEN <b>EJ</b> , DARK GREEN <b>EL</b> , GOLDEN YELLOW <b>EO</b> , CHERRY RED <b>EQ</b> , RED <b>ER</b> , ASH GREY <b>ES</b> , LIGHT GREY <b>ET</b> , TRANSPARENT MATT <b>EW</b> , BRONZE <b>EZ</b> + TRANSP., BULGARO RED <b>FP</b> |

## Fold Kit 2 luggage hooks

Metal INOX

| Version | Code | -- | -- | Accessoires | Optional | Q.ty | boxes | Kg | M <sup>3</sup> |
|---------|------|----|----|-------------|----------|------|-------|----|----------------|
|---------|------|----|----|-------------|----------|------|-------|----|----------------|

### Accessoires INOX

|                |           |  |  | M1   |  |   |   |      |       |
|----------------|-----------|--|--|------|--|---|---|------|-------|
| 70x70          | A2330Q070 |  |  | 26 € |  | 1 | 1 | 0.55 | 0.002 |
| 80x80 - 120x80 | A2330Q080 |  |  | 26 € |  | 1 | 1 | 0.60 | 0.002 |
| 90x90          | A2330Q090 |  |  | 26 € |  | 1 | 1 | 0.70 | 0.002 |
| 100x100        | A2330Q100 |  |  | 26 € |  | 1 | 1 | 0.75 | 0.002 |

#### 70x70

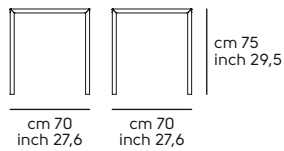

#### 80x80

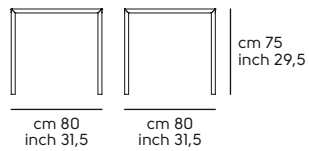

#### 90x90

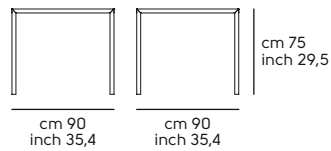

#### 100x100

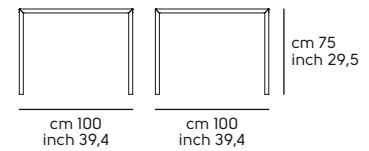

#### 120x80

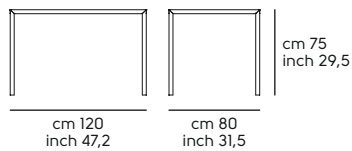

# Forest design Beatriz Sempere

## Table Forest

Frame in: metal



| Version | Code | Legs | Frame | Top | Optional | Q.ty | boxes | Kg | M <sup>3</sup> |
|---------|------|------|-------|-----|----------|------|-------|----|----------------|
|---------|------|------|-------|-----|----------|------|-------|----|----------------|

### Forest Veneer

Top 20 mm. thk

|                    |          |    |    | LI1     | LI2     |       |   |   |     |      |
|--------------------|----------|----|----|---------|---------|-------|---|---|-----|------|
| D. 150             | T1702150 | MI | MI | 2.857 € | 2.991 € | FM-M2 | 1 | 4 | 108 | 1.40 |
| 280x120 Elliptical | T1706280 |    |    | 3.782 € | 3.972 € |       | 1 | 4 | 137 | 1.87 |

### Note:

280x120 elliptical ONLY I04-I05-I24-I40-I22-I24

### Forest wood

Top 40 mm. thk

|         |          |    |    | LS1     | LS2     |       |   |   |     |      |
|---------|----------|----|----|---------|---------|-------|---|---|-----|------|
| 200x106 | T1700200 | MI | MI | 3.846 € | 4.132 € | FM-M2 | 1 | 4 | 142 | 1.40 |
| 250x106 | T1700250 |    |    | 4.388 € | 4.682 € |       | 1 | 4 | 169 | 1.73 |

| Version | Code | Legs | Frame | Top | Optional | Q.ty | boxes | Kg | M <sup>3</sup> |
|---------|------|------|-------|-----|----------|------|-------|----|----------------|
|---------|------|------|-------|-----|----------|------|-------|----|----------------|

### Forest Ceramic

Top 16 mm. thk D.150 - Top 18 mm. thk Elliptical 280x120

|                    |          |    |    | GMA     |  |       |   |   |     |      |
|--------------------|----------|----|----|---------|--|-------|---|---|-----|------|
| D. 150             | T1702150 | MI | MI | 3.970 € |  | FM-M2 | 1 | 4 | 148 | 1.40 |
| 280x120 Elliptical | T1706280 |    |    | 5.640 € |  |       | 1 | 4 | 202 | 1.87 |

| Version | Code | Legs | Frame | Top | Optional | Q.ty | boxes | Kg | M <sup>3</sup> |
|---------|------|------|-------|-----|----------|------|-------|----|----------------|
|---------|------|------|-------|-----|----------|------|-------|----|----------------|

### Forest Marble

Top 20 mm. thk

|                    |          |    |    | GMM     |  |       |   |   |     |     |
|--------------------|----------|----|----|---------|--|-------|---|---|-----|-----|
| D. 150             | T1702150 | MI | MI | 5.406 € |  | FM-M2 | 1 | 4 | 180 | 1.4 |
| 280x120 Elliptical | T1706280 |    |    | 6.814 € |  |       | 1 | 4 | 250 | 1.9 |

### Note:

Top D.150 - NO Ceramic GMA K46

**Frame finishes**

**Metal**

|           |   |
|-----------|---|
| <b>MI</b> | WHITE <b>BB</b> , BROWN <b>E6</b> , SAND <b>EC</b> , WHITE PEARL <b>EF</b> , GRAPHITE <b>EG</b> , BLACK <b>EN</b> |
|-----------|---|

**Legs finishes**

**Metal**

|           |   |
|-----------|---|
| <b>MI</b> | WHITE <b>BB</b> , BROWN <b>E6</b> , SAND <b>EC</b> , WHITE PEARL <b>EF</b> , GRAPHITE <b>EG</b> , BLACK <b>EN</b> |
|-----------|---|

**Top finishes**

**Veneer**

|            |   |
|------------|---|
| <b>LI1</b> | Stained BLACK <b>I04</b> , Stained WHITE <b>I05</b> , Stained NATURAL <b>I40</b> , Stained WHITENED <b>I60</b> , Stained DESERT <b>I61</b> , Stained LIGHT GREY <b>I62</b> , Stained DARK GREY <b>I63</b> |
| <b>LI2</b> | NATURAL OAK <b>I22</b> , FLAMED WALNUT <b>I24</b>   |

**Solid ashwood**

|            |                                   |
|------------|-----------------------------------|
| <b>LS1</b> | IM OAK STRAIGHT EDGE <b>WR1</b>   |
| <b>LS2</b> | SOLID WALNUT BARK EDGE <b>WN1</b> |

**Crystal Ceramic and Ceramic**

|            |   |
|------------|---|
| <b>GMA</b> | MARBLE CALACATTA GLOSSY WHITE <b>K32</b> , BLACK GREEK MARBLE <b>K33</b> , MARBLE GLOSSY NOIR DESIR <b>K35</b> , MARBLE CALACATTA MATT WHITE <b>K42</b> , MARBLE MATT NOIR DESIR <b>K45</b> , MARBLE MATT GREEN TINOS <b>K46</b> , MARBLE STATUARIO WHITE MATT <b>K47</b> , MARBLE CALACAT BLACK Bush Hammered <b>K50</b> |
|------------|---|

**Marble**

|            |   |
|------------|---|
| <b>GMM</b> | BEIGE TRAVERTINO ROMANO <b>MB2</b> , WHITE CALACATTA VAGLI <b>MB4</b> , BLACK MARQUINIA <b>MN4</b> , GREEN TINOS <b>MVE</b> |
|------------|---|

**Optionals:**

|              | Value   | Options/notes  |
|--------------|---------|--|
| <b>FM-M2</b> | + 197 € | ASH GREY <b>ES</b> , BLUE SAPPHIRE <b>EE</b> , BLUE TURQUOISE <b>EH</b> , BRONZE <b>E2</b> , BULGARO RED <b>FP</b> , CHERRY RED <b>EQ</b> , DARK GREEN <b>EL</b> , FACEPOWDER PINK <b>E8</b> , FANGO <b>E3</b> , GOLDEN YELLOW <b>EO</b> , LIGHT BLUE <b>EO</b> , LIGHT GREY <b>ET</b> , OCEAN BLUE <b>E1</b> , OCHER YELLOW <b>E7</b> , PAPAYA ORANGE <b>EA</b> , PASTEL YELLOW <b>E4</b> , PINE GREEN <b>EJ</b> , RED <b>ER</b> , SAGE GREEN <b>E9</b> |

**D. 150**

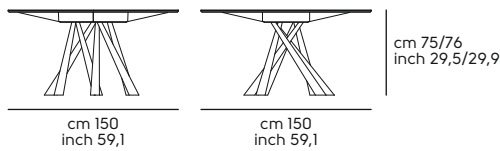

**280x120 Elliptical**

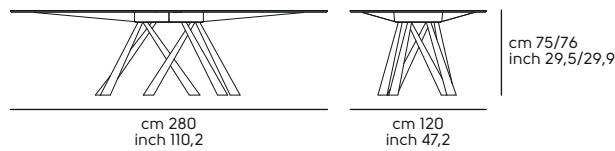

**200x106**

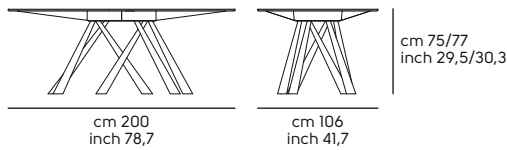

**250x106**

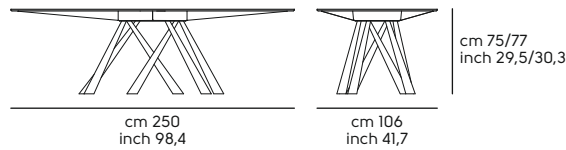

# Gran Sasso design Andrea Lucatello

## Table Gran Sasso

Frame in: baydur with hide inserts



| Version | Code | Insert | Frame | Top | Optional | Q.ty | boxes | Kg | M <sup>3</sup> |
|---------|------|--------|-------|-----|----------|------|-------|----|----------------|
|---------|------|--------|-------|-----|----------|------|-------|----|----------------|

### Gran Sasso Glass

Top 15 mm. thk - 250x120 CATAS certificated

|                |          |    |     | GVB     | GVE     | GVH     |                |   |   |     |      |
|----------------|----------|----|-----|---------|---------|---------|----------------|---|---|-----|------|
| 220x116 Barrel | T1821220 | CK | PBI | 3.538 € | 3.888 € | 4.346 € | FP-B2<br>RV-CT | 1 | 2 | 150 | 0.77 |
| 250x120 Barrel | T1821250 |    |     | 3.975 € | 4.237 € | 4.598 € |                | 1 | 2 | 165 | 0.77 |

### Gran Sasso Ceramic

Top 18 mm. thk - 250x120 CATAS certificated

|                |          |    |     | GMA     |  |  |                |   |   |     |      |
|----------------|----------|----|-----|---------|--|--|----------------|---|---|-----|------|
| 220x116 Barrel | T1821220 | CK | PBI | 4.827 € |  |  | FP-B2<br>RV-CT | 1 | 2 | 175 | 0.77 |
| 250x120 Barrel | T1821250 |    |     | 5.105 € |  |  |                | 1 | 2 | 195 | 0.77 |

### Frame finishes

#### Baydur

|            |   |
|------------|---|
| <b>PBI</b> | WHITE <b>BB4</b> , ASH GREY <b>BGS</b> , DARK GREY <b>BGW</b> |
|------------|---|

### Insert finishes

#### Hide

|           |         |
|-----------|---------|
| <b>CK</b> | HIDE_TK |
|-----------|---------|

### Top finishes

#### Glossy Glass

|            |                                    |
|------------|------------------------------------|
| <b>GVB</b> | EXTRA CLEAR TRANSPARENT <b>J01</b> |
| <b>GVE</b> | GLOSSY FUME' <b>J05</b>            |

#### Glass with Bucciato finish

|            |                           |
|------------|---------------------------|
| <b>GVH</b> | BUCCIATO FUME' <b>J50</b> |
|------------|---------------------------|

#### Crystal Ceramic and Ceramic

|            |  |
|------------|--|
| <b>GMA</b> | MARBLE CALACATTA GLOSSY WHITE <b>K32</b> , BLACK GREEK MARBLE <b>K33</b> , MARBLE GLOSSY NOIR DESIR <b>K35</b> , MARBLE CALACATTA MATT WHITE <b>K42</b> , MARBLE MATT NOIR DESIR <b>K45</b> , MARBLE MATT GREEN TINOS <b>K46</b> |
|------------|--|

### Optionals:

|              |             | Value   | Options/notes  |
|--------------|-------------|---------|--|
| <b>FP-B2</b> | Baydur PB2  | + 972 € | BRUSHED CONCRETE DARK GREY <b>CGW</b> , BRUSHED CONCRETE LIGHT GREY <b>CGT</b> |
| <b>RV-CT</b> | Tuscan hide | + 87 €  | TUSCAN HIDE  |

#### 220x116 Barrel

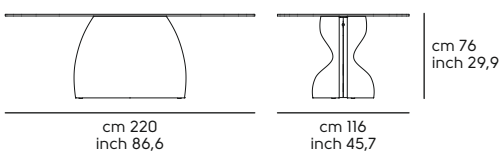

#### 250x120 Barrel

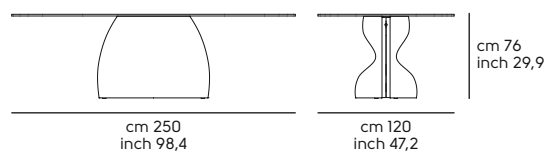

# Infinity design Officina delle Idee

## Table Infinity

Frame in: metal



| Version | Code | -- | Frame | Top | Optional | Q.ty | boxes | Kg | M <sup>3</sup> |
|---------|------|----|-------|-----|----------|------|-------|----|----------------|
|---------|------|----|-------|-----|----------|------|-------|----|----------------|

### Infinity Melamine HL

Top 18 mm. thk D. 60-70-80- Top 36 mm. thk D.90-100-120

|                       |          |  |    | HL1   |       |   |   |      |      |
|-----------------------|----------|--|----|-------|-------|---|---|------|------|
| Base D.44 / Top D. 60 | T0190D06 |  |    | 396 € |       | 1 | 2 | 16.5 | 0.23 |
| Base D.44 / Top D. 70 | T0190D07 |  |    | 418 € |       | 1 | 2 | 19.5 | 0.24 |
| Base D.44 / Top D. 80 | T0190D08 |  | M1 | 442 € | FM-M2 | 1 | 2 | 22.5 | 0.26 |
| Base D.70 / Top D. 90 | T0190D09 |  |    | 617 € | FM-M3 | 1 | 2 | 28   | 0.20 |
| Base D.70 / Top D.100 | T0190D10 |  |    | 652 € |       | 1 | 2 | 35   | 0.20 |
| Base D.70 / Top D.120 | T0190D12 |  |    | 700 € |       | 1 | 2 | 44   | 0.25 |

### Infinity HPL

Top 10 mm. thk

|                       |          |  |    | HH1   | HH2   | HH3   |       |   |   |      |      |
|-----------------------|----------|--|----|-------|-------|-------|-------|---|---|------|------|
| Base D.44 / Top D. 60 | T0190D06 |  |    | 462 € | 468 € | 499 € |       | 1 | 2 | 16.5 | 0.23 |
| Base D.44 / Top D. 70 | T0190D07 |  |    | 515 € | 523 € | 560 € |       | 1 | 2 | 19.5 | 0.24 |
| Base D.44 / Top D. 80 | T0190D08 |  | M1 | 530 € | 542 € | 573 € | FM-M2 | 1 | 2 | 22.5 | 0.26 |
| Base D.70 / Top D. 90 | T0190D09 |  |    | 718 € | 728 € | 745 € | FM-M3 | 1 | 2 | 26   | 0.26 |

### Infinity Glass

Top 10 mm. thk

|                       |          |  |    | GVB   |  |   |   |      |      |  |
|-----------------------|----------|--|----|-------|--|---|---|------|------|--|
| Base D.44 / Top D. 60 | T0190D06 |  |    | 560 € |  | 1 | 2 | 16.5 | 0.23 |  |
| Base D.44 / Top D. 70 | T0190D07 |  |    | 573 € |  | 1 | 2 | 19.5 | 0.24 |  |
| Base D.44 / Top D. 80 | T0190D08 |  | M1 | 593 € |  | 1 | 2 | 22.5 | 0.26 |  |
| Base D.70 / Top D. 90 | T0190D09 |  |    | 787 € |  | 1 | 2 | 30   | 0.20 |  |
| Base D.70 / Top D.100 | T0190D10 |  |    | 894 € |  | 1 | 2 | 35   | 0.20 |  |
| Base D.70 / Top D.120 | T0190D12 |  |    | 979 € |  | 1 | 2 | 44   | 0.25 |  |

### Infinity Ceramic

Top 11-14 mm. thk

|                       |          |  |    | GKA     | GKB     | GMA     |       |   |   |      |      |
|-----------------------|----------|--|----|---------|---------|---------|-------|---|---|------|------|
| Base D.44 / Top D. 60 | T0190D06 |  |    | 773 €   | 827 €   | 872 €   |       | 1 | 2 | 16.5 | 0.23 |
| Base D.44 / Top D. 70 | T0190D07 |  |    | 912 €   | 1.026 € | 1.090 € |       | 1 | 2 | 19.5 | 0.24 |
| Base D.44 / Top D. 80 | T0190D08 |  | M1 | 1.088 € | 1.197 € | 1.302 € | FM-M2 | 1 | 2 | 22.5 | 0.26 |
| Base D.70 / Top D. 90 | T0190D09 |  |    | 1.136 € | 1.204 € | 1.375 € | FM-M3 | 1 | 2 | 28   | 0.20 |
| Base D.70 / Top D.100 | T0190D10 |  |    | 1.150 € | 1.316 € | 1.402 € |       | 1 | 2 | 35   | 0.20 |
| Base D.70 / Top D.120 | T0190D12 |  |    | --      | --      | 1.668 € |       | 1 | 2 | 44   | 0.25 |

**Infinity Metal**

Top 15 mm. thk (Hydrophobic MDF 12 mm thk+metal)

|                          |          |  |    | M1    | M2    |                |   |   |      |      |
|--------------------------|----------|--|----|-------|-------|----------------|---|---|------|------|
| Base D.44 / Top D. 60_MT | T0191D06 |  |    | 452 € | 480 € | FM-M2<br>FM-M3 | 1 | 2 | 16.5 | 0.23 |
| Base D.44 / Top D. 70_MT | T0191D07 |  | M1 | 478 € | 506 € |                | 1 | 2 | 19.5 | 0.24 |
| Base D.44 / Top D. 80_MT | T0191D08 |  |    | 544 € | 572 € |                | 1 | 2 | 22.5 | 0.26 |

**Infinity sheet metal**

Top 3 mm. thk

|                            |          |  |    | M1    | M2    |                |   |   |      |      |
|----------------------------|----------|--|----|-------|-------|----------------|---|---|------|------|
| Base D.44 / Top D. 70_SP.3 | T0192D07 |  |    | 442 € | 470 € | FM-M2<br>FM-M3 | 1 | 2 | 19.5 | 0.24 |
| Base D.44 / Top D. 80_SP.3 | T0192D08 |  | M1 | 458 € | 485 € |                | 1 | 2 | 22.5 | 0.26 |

**Note:**

Top Ceramic K26 D.100 reduced diameter - D.120 NOT available - Top Ceramic K55,K90,K91 D.120 reduced diameter

**Frame finishes****Metal**

|           |   |
|-----------|---|
| <b>MI</b> | WHITE <b>BB</b> , BROWN <b>E6</b> , SAND <b>EC</b> , WHITE PEARL <b>EF</b> , GRAPHITE <b>EG</b> , BLACK <b>EN</b> |
|-----------|---|

**Top finishes****Melamine**

|            |  |
|------------|--|
| <b>HLI</b> | WHITE <b>M01</b> , GRAFITE <b>M02</b> , BLACK <b>M04</b> , SAND <b>M07</b> |
|------------|--|

**HPL**

|            |  |
|------------|--|
| <b>HH1</b> | WHITE/Black Core <b>HB4</b> , BLACK/Black Core <b>HN4</b>  |
| <b>HH2</b> | CEMENT/Black Core <b>HC6</b> , CORTEN/Brown Core <b>HC7</b> , DARK GREY/Black Core <b>HGW</b>  |
| <b>HH3</b> | ST WHITE/White Core <b>AB4</b> , ST SAND/Sand Core <b>ACR</b> , ST GRAPHITE GREY/ Grafite Core <b>AGD</b> , ST BLACK/Black Core <b>AN4</b> , ST TORTORA/Tortora Core <b>ATR</b> , ST RED NAMIB/Red Core <b>FAM</b> , ST YELLOW EVORA/Yellow Core <b>FGO</b> , ST RED BULGARO/Red Core <b>FRB</b> , ST GREEN KITAMI/Green Core <b>FVK</b> |

**Crystal Ceramic and Ceramic**

|            |  |
|------------|--|
| <b>GKA</b> | CHARCOAL SAVOIA <b>K11</b> , CEMENT SAVOIA <b>K12</b>  |
| <b>GKB</b> | WHITE CALCE <b>K24</b> , BLACK CALCE <b>K25</b> , TORTORA CALCE <b>K26</b> , PIASENTINA STONE TAUPE Materica <b>K55</b> , TERRACOTTA Matt <b>K90</b> , MATT GREEN <b>K91</b> |

**Metal**

|           |  |
|-----------|--|
| <b>MI</b> | WHITE <b>BB</b> , BROWN <b>E6</b> , SAND <b>EC</b> , WHITE PEARL <b>EF</b> , GRAPHITE <b>EG</b> , BLACK <b>EN</b>  |
| <b>M2</b> | LIGHT BLUE <b>E0</b> , OCEAN BLUE <b>E1</b> , BRONZE <b>E2</b> , FANGO <b>E3</b> , PASTEL YELLOW <b>E4</b> , OCHER YELLOW <b>E7</b> , FACEPOWDER PINK <b>E8</b> , SAGE GREEN <b>E9</b> , PAPAYA ORANGE <b>EA</b> , BLUE SAPPHIRE <b>EE</b> , BLUE TURQUOISE <b>EH</b> , PINE GREEN <b>EJ</b> , DARK GREEN <b>EL</b> , GOLDEN YELLOW <b>EO</b> , CHERRY RED <b>EQ</b> , RED <b>ER</b> , ASH GREY <b>ES</b> , LIGHT GREY <b>ET</b> , BULGARO RED <b>FP</b> |

**Glossy Glass**

|            |                                    |
|------------|------------------------------------|
| <b>GVB</b> | EXTRA CLEAR TRANSPARENT <b>J01</b> |
|------------|------------------------------------|

**Crystal Ceramic and Ceramic**

|            |   |
|------------|---|
| <b>GMA</b> | MARBLE CALACATTA GLOSSY WHITE <b>K32</b> , BLACK GREEK MARBLE <b>K33</b> , MARBLE GLOSSY NOIR DESIR <b>K35</b> , MARBLE CALACATTA MATT WHITE <b>K42</b> , MARBLE MATT NOIR DESIR <b>K45</b> , MARBLE MATT GREEN TINOS <b>K46</b> , MARBLE STATUARIO WHITE MATT <b>K47</b> , MARBLE CALACAT BLACK Bush Hammered <b>K50</b> |
|------------|---|

**Optionals:**

|              |                        | Value   | Options/notes  |
|--------------|------------------------|---------|--|
| <b>FM-M3</b> | Indoor glossy metal M3 | + 69 €  | CHROME <b>CC</b>   |
| <b>FM-M2</b> | Indoor matt metal M2   | + 137 € | ASH GREY <b>ES</b> , BLUE SAPPHIRE <b>EE</b> , BLUE TURQUOISE <b>EH</b> , BRONZE <b>E2</b> , BULGARO RED <b>FP</b> , CHERRY RED <b>EQ</b> , DARK GREEN <b>EL</b> , FACEPOWDER PINK <b>E8</b> , FANGO <b>E3</b> , GOLDEN YELLOW <b>EO</b> , LIGHT BLUE <b>E0</b> , LIGHT GREY <b>ET</b> , OCEAN BLUE <b>E1</b> , OCHER YELLOW <b>E7</b> , PAPAYA ORANGE <b>EA</b> , PASTEL YELLOW <b>E4</b> , PINE GREEN <b>EJ</b> , RED <b>ER</b> , SAGE GREEN <b>E9</b> |

**Base D.44 / Top D. 60**

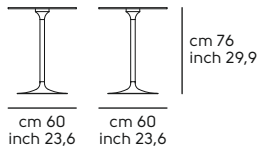

**Base D.44 / Top D. 70**

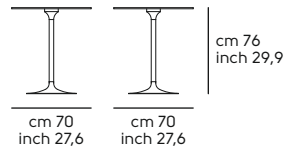

**Base D.44 / Top D. 80**

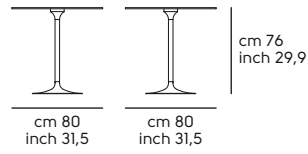

**Base D.70 / Top D.90**

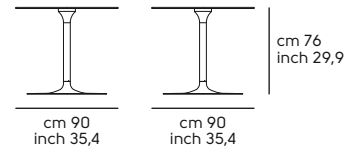

**Base D.70 / Top D.100**

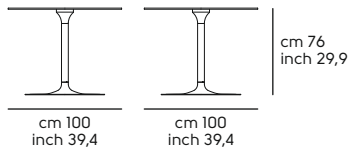

**Base D.70 / Top D.120**

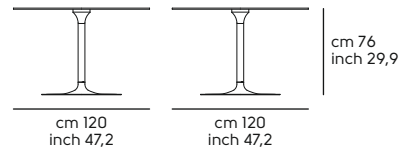

# Lea design Paolo Vernier

## Table Lea

Frame in: metal



| Version | Code | -- | Frame | Top | Optional | Q.ty | boxes | Kg | M <sup>3</sup> |
|---------|------|----|-------|-----|----------|------|-------|----|----------------|
|---------|------|----|-------|-----|----------|------|-------|----|----------------|

### Lea Veneer

Top 19 mm. thk

|         |          |  |    | L11     | L12     |       |   |   |     |      |
|---------|----------|--|----|---------|---------|-------|---|---|-----|------|
| 190x115 | T1940190 |  | MI | 2.458 € | 2.589 € | FM-M2 | 1 | 3 | 100 | 0.35 |
| 220x120 | T1940220 |  | MI | 2.610 € | 2.861 € |       | 1 | 3 | 140 | 0.53 |

### Lea Ceramic

Top 16 mm. thk

|         |          |  |    | GKB     | GMA     |       |   |   |     |      |
|---------|----------|--|----|---------|---------|-------|---|---|-----|------|
| 190x115 | T1940190 |  | MI | 3.390 € | 3.691 € | FM-M2 | 1 | 3 | 100 | 0.35 |
| 220x120 | T1940220 |  | MI | 3.790 € | 3.850 € |       | 1 | 3 | 140 | 0.53 |

### Frame finishes

#### Metal

|           |   |
|-----------|---|
| <b>MI</b> | WHITE <b>BB</b> , BROWN <b>E6</b> , SAND <b>EC</b> , WHITE PEARL <b>EF</b> , GRAPHITE <b>EG</b> , BLACK <b>EN</b> |
|-----------|---|

### Legs finishes

#### Metal

|           |   |
|-----------|---|
| <b>MI</b> | WHITE <b>BB</b> , BROWN <b>E6</b> , SAND <b>EC</b> , WHITE PEARL <b>EF</b> , GRAPHITE <b>EG</b> , BLACK <b>EN</b> |
|-----------|---|

### Top finishes

#### Veneer

|            |  |
|------------|--|
| <b>L11</b> | Stained BLACK <b>I04</b> , Stained NATURAL <b>I40</b> , Stained WHITENED <b>I60</b> , Stained DESERT <b>I61</b> , Stained LIGHT GREY <b>I62</b> , Stained DARK GREY <b>I63</b> |
| <b>L12</b> | NATURAL OAK <b>I22</b> , FLAMED WALNUT <b>I24</b>  |

#### Crystal Ceramic and Ceramic

|            |   |
|------------|---|
| <b>GKB</b> | WHITE CALCE <b>K24</b> , BLACK CALCE <b>K25</b> , PIASENTINA STONE TAUPE Materica <b>K55</b> , TERRACOTTA Matt <b>K90</b> , MATT GREEN <b>K91</b>   |
| <b>GMA</b> | MARBLE CALACATTA GLOSSY WHITE <b>K32</b> , BLACK GREEK MARBLE <b>K33</b> , MARBLE GLOSSY NOIR DESIR <b>K35</b> , MARBLE CALACATTA MATT WHITE <b>K42</b> , MARBLE MATT NOIR DESIR <b>K45</b> , MARBLE MATT GREEN TINOS <b>K46</b> , MARBLE STATUARIO WHITE MATT <b>K47</b> , MARBLE CALACAT BLACK Bush Hammered <b>K50</b> |

### Optionals:

|              | Value   | Options/notes  |
|--------------|---------|--|
| <b>FM-M2</b> | + 164 € | Indoor matt metal M2<br>ASH GREY <b>ES</b> , BLUE SAPPHIRE <b>EE</b> , BLUE TURQUOISE <b>EH</b> , BRONZE <b>E2</b> , BULGARO RED <b>FP</b> , CHERRY RED <b>EQ</b> , DARK GREEN <b>EL</b> , FACEPOWDER PINK <b>E8</b> , FANGO <b>E3</b> , GOLDEN YELLOW <b>EO</b> , LIGHT BLUE <b>EO</b> , LIGHT GREY <b>ET</b> , OCEAN BLUE <b>E1</b> , OCHER YELLOW <b>E7</b> , PAPAYA ORANGE <b>EA</b> , PASTEL YELLOW <b>E4</b> , PINE GREEN <b>EJ</b> , RED <b>ER</b> , SAGE GREEN <b>E9</b> |

### 190x115

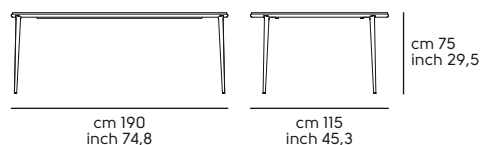

### 220x120

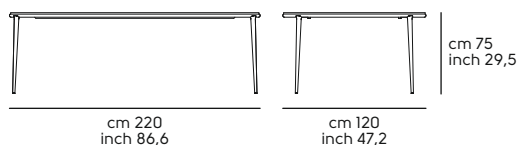

# Link design Studio 28

## Table Link

Frame in: metal



| Version | Code | Legs | Frame | Top and extensions | Optional | Q.ty | boxes | Kg | M³ |
|---------|------|------|-------|--------------------|----------|------|-------|----|----|
|---------|------|------|-------|--------------------|----------|------|-------|----|----|

### Link Veneer

Top and extensions 20 mm thk

|                      |          |    |    | L11     | L12     |       |   |   |    |      |
|----------------------|----------|----|----|---------|---------|-------|---|---|----|------|
| D. 120/180           | T0220D12 | M1 | M1 | 2.520 € | 2.547 € | FM-M2 | 1 | 2 | 51 | 0.92 |
| 120/180x120 - Barrel | T0220I20 |    |    | 2.472 € | 2.521 € |       | 1 | 2 | 51 | 0.92 |

### Link Ceramic

Top 14 mm. thk

|                      |          |    |    | GKA     | GKB     |       |   |   |    |      |
|----------------------|----------|----|----|---------|---------|-------|---|---|----|------|
| D. 120/180           | T0220D12 | M1 | M1 | 3.726 € | 3.825 € | FM-M2 | 1 | 2 | 51 | 0.92 |
| 120/180x120 - Barrel | T0220I20 |    |    | 3.696 € | 3.797 € |       | 1 | 2 | 51 | 0.92 |

### Note:

For Glass or Crystal Ceramic tops, extensions in the same material

### Frame finishes

#### Metal

**M1** WHITE **BB**, BROWN **E6**, SAND **EC**, WHITE PEARL **EF**, GRAPHITE **EG**, BLACK **EN**

### Legs finishes

#### Metal

**M1** WHITE **BB**, BROWN **E6**, SAND **EC**, WHITE PEARL **EF**, GRAPHITE **EG**, BLACK **EN**

### Top and extensions finishes

#### Veneer

**L11** Stained BLACK **I04**, Stained WHITE **I05**, Stained NATURAL **I40**, Stained WHITENED **I60**, Stained DESERT **I61**, Stained LIGHT GREY **I62**, Stained DARK GREY **I63**

**L12** NATURAL OAK **I22**, FLAMED WALNUT **I24**

#### Crystal Ceramic and Ceramic

**GKA** CHARCOAL SAVOIA **K11**, CEMENT SAVOIA **K12**

**GKB** WHITE CALCE **K24**, BLACK CALCE **K25**, TORTORA CALCE **K26**

### Optionals:

|              |                      | Value   | Options/notes  |
|--------------|----------------------|---------|--|
| <b>FM-M2</b> | Indoor matt metal M2 | + 164 € | ASH GREY <b>ES</b> , BLUE SAPPHIRE <b>EE</b> , BLUE TURQUOISE <b>EH</b> , BRONZE <b>E2</b> , BULGARO RED <b>FP</b> , CHERRY RED <b>EQ</b> , DARK GREEN <b>EL</b> , FACEPOWDER PINK <b>EB</b> , FANGO <b>E3</b> , GOLDEN YELLOW <b>EO</b> , LIGHT BLUE <b>EO</b> , LIGHT GREY <b>ET</b> , OCEAN BLUE <b>E1</b> , OCHER YELLOW <b>E7</b> , PAPAYA ORANGE <b>EA</b> , PASTEL YELLOW <b>E4</b> , PINE GREEN <b>EJ</b> , RED <b>ER</b> , SAGE GREEN <b>E9</b> |

### D. 120/180

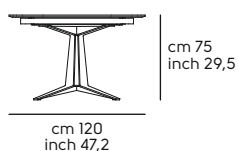
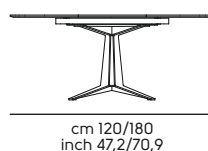

### 120/180x120 - Barrel

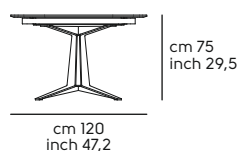
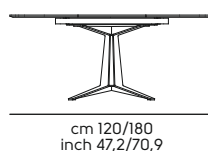

# Marcopolo design Paolo Vernier

## Table Marcopolo

Frame in: metal



T  
A  
B  
L  
E  
S

| Version | Code | Legs | Frame | Top and extensions | Optional | Q.ty | boxes | Kg | M <sup>3</sup> |
|---------|------|------|-------|--------------------|----------|------|-------|----|----------------|
|---------|------|------|-------|--------------------|----------|------|-------|----|----------------|

### Marcopolo Glass

Top and extensions 10 mm thk

|             |          |    |    | GVC     | GVD     |       |   |   |     |      |
|-------------|----------|----|----|---------|---------|-------|---|---|-----|------|
| 140/230x140 | T1848140 | M1 | M1 | 3.039 € | 3.199 € | FM-M2 | 1 | 3 | 116 | 1.35 |

### Marcopolo Ceramic

Top and extensions 11 mm thk | ATTENTION ! GMA: Top and Extensions 14 mm thk

|             |          |    |    | GKA     | GMA     |       |   |   |     |      |
|-------------|----------|----|----|---------|---------|-------|---|---|-----|------|
| 140/230x140 | T1848140 | M1 | M1 | 4.172 € | 4.811 € | FM-M2 | 1 | 3 | 116 | 1.35 |

### Marcopolo Veneer

Top and extensions 14 mm thk

|             |          |    |    | L11     | L12     |       |   |   |    |      |
|-------------|----------|----|----|---------|---------|-------|---|---|----|------|
| 140/230x140 | T1840140 | M1 | M1 | 4.274 € | 5.055 € | FM-M2 | 1 | 3 | 85 | 1.35 |

### Frame finishes

#### Metal

**MI** WHITE **BB**, BROWN **E6**, SAND **EC**, WHITE PEARL **EF**, GRAPHITE **EG**, BLACK **EN**

### Legs finishes

#### Metal

**MI** WHITE **BB**, BROWN **E6**, SAND **EC**, WHITE PEARL **EF**, GRAPHITE **EG**, BLACK **EN**

### Top and extensions finishes

#### Veneer

**L11** Stained BLACK **I04**, Stained WHITENED **I60**, Stained DESERT **I61**, Stained LIGHT GREY **I62**, Stained DARK GREY **I63**

**L12** NATURAL OAK **I22**, FLAMED WALNUT **I24**

#### Satin Glass

**GVC** MATT GRAFITE ANTISCRATCH **J31**, MATT SAND ANTISCRATCH **J32**

**GVD** EXTRA CLEAR MATT WHITE ANTISCRATCH **J41**

### Crystal Ceramic and Ceramic

**GKA** CHARCOAL SAVOIA **K11**, CEMENT SAVOIA **K12**

### Crystal Ceramic and Ceramic

**GMA** MARBLE CALACATTA GLOSSY WHITE **K32**, BLACK GREEK MARBLE **K33**, MARBLE GLOSSY NOIR DESIR **K35**, MARBLE CALACATTA MATT WHITE **K42**, MARBLE MATT NOIR DESIR **K45**, MARBLE STATUARIO WHITE MATT **K47**, MARBLE CALACAT BLACK Bush Hammered **K50**

### Optionals:

|              | Value                | Options/notes   |
|--------------|----------------------|---|
| <b>FM-M2</b> | Indoor matt metal M2 | + 161 €<br>ASH GREY <b>ES</b> , BLUE SAPPHIRE <b>EE</b> , BLUE TURQUOISE <b>EH</b> , BRONZE <b>E2</b> , BULGARO RED <b>FP</b> , CHERRY RED <b>EQ</b> , DARK GREEN <b>EL</b> , FACEPOWDER PINK <b>E8</b> , FANGO <b>E3</b> , GOLDEN YELLOW <b>EO</b> , LIGHT BLUE <b>EO</b> , LIGHT GREY <b>ET</b> , OCEAN BLUE <b>E1</b> , OCHER YELLOW <b>E7</b> , PAPAYA ORANGE <b>EA</b> , PASTEL YELLOW <b>E4</b> , PINE GREEN <b>EJ</b> , RED <b>ER</b> , SAGE GREEN <b>E9</b> |

### 140/230x140

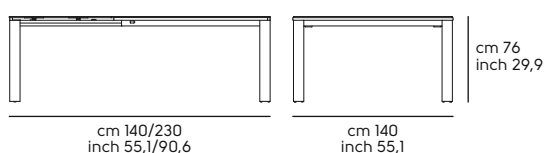

# Moonlight design Franco Poli

## Table Moonlight

Frame in: baydur



| Version | Code | -- | Frame | Top | Optional | Q.ty | boxes | Kg | M <sup>3</sup> |
|---------|------|----|-------|-----|----------|------|-------|----|----------------|
|---------|------|----|-------|-----|----------|------|-------|----|----------------|

### Moonlight Glass

Top 12 mm. thk

|         |          |  |     | GVB     | GVE     |   |   |     |      |
|---------|----------|--|-----|---------|---------|---|---|-----|------|
| 200x100 | T0240200 |  | PBI | 2.501 € | 2.661 € | 1 | 2 | 88  | 0.60 |
| 220x116 | T0240220 |  | PBI | 2.644 € | 2.780 € | 1 | 2 | 105 | 0.60 |

### Moonlight Ceramic

Top 16 mm. thk

|         |          |  |     | GMA     |  |   |   |     |      |
|---------|----------|--|-----|---------|--|---|---|-----|------|
| 200x100 | T0240200 |  | PBI | 4.138 € |  | 1 | 2 | 88  | 0.60 |
| 220x116 | T0240220 |  | PBI | 4.495 € |  | 1 | 2 | 105 | 0.60 |

### Frame finishes

#### Baydur

**PBI** WHITE BB4, DARK GREY BGW

### Top finishes

#### Glossy Glass

**GVB** EXTRA CLEAR TRANSPARENT J01

**GVE** GLOSSY FUME' J05

#### Crystal Ceramic and Ceramic

**GMA** MARBLE CALACATTA GLOSSY WHITE K32, BLACK GREEK MARBLE K33, MARBLE GLOSSY NOIR DESIR K35, MARBLE CALACATTA MATT WHITE K42, MARBLE MATT NOIR DESIR K45, MARBLE MATT GREEN TINOS K46, MARBLE STATUARIO WHITE MATT K47, MARBLE CALACAT BLACK Bush Hammered K50

#### 200x100

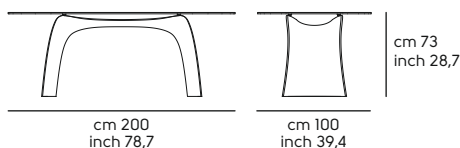

#### 220x116

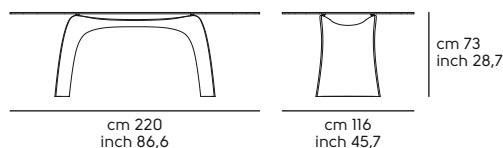

# More design Officina delle Idee

## Table More

Frame in: metal



| Version | Code | Legs | Frame | Top | Optional | Q.ty | boxes | Kg | M <sup>3</sup> |
|---------|------|------|-------|-----|----------|------|-------|----|----------------|
|---------|------|------|-------|-----|----------|------|-------|----|----------------|

### More Melamine HL

Top 18 mm. thk

|         |          |    |    | HL1     |       |   |   |      |      |
|---------|----------|----|----|---------|-------|---|---|------|------|
| 100x 70 | T1810010 |    |    | 630 €   |       | 1 | 3 | 33.4 | 0.17 |
| 110x 80 | T1810011 |    |    | 730 €   |       | 1 | 3 | 37.5 | 0.19 |
| 120x 80 | T1810012 | M1 | M1 | 765 €   | FM-M2 | 1 | 3 | 38.5 | 0.20 |
| 140x 90 | T1810014 |    |    | 850 €   |       | 1 | 3 | 43.4 | 0.24 |
| 160x 90 | T1810016 |    |    | 970 €   |       | 1 | 3 | 45.7 | 0.25 |
| 180x 90 | T1810018 |    |    | 1.090 € |       | 1 | 3 | 51.5 | 0.29 |

### More MDF

Top 19 mm. thk

|         |          |    |    | LM1     |       |   |   |      |      |
|---------|----------|----|----|---------|-------|---|---|------|------|
| 100x 70 | T1810010 |    |    | 830 €   |       | 1 | 3 | 33.4 | 0.17 |
| 110x 80 | T1810011 |    |    | 1.070 € |       | 1 | 3 | 37.5 | 0.19 |
| 120x 80 | T1810012 | M1 | M1 | 1.130 € | FM-M2 | 1 | 3 | 38.5 | 0.20 |
| 140x 90 | T1810014 |    |    | 1.290 € |       | 1 | 3 | 43.4 | 0.24 |
| 160x 90 | T1810016 |    |    | 1.430 € |       | 1 | 3 | 45.7 | 0.25 |
| 180x 90 | T1810018 |    |    | 1.630 € |       | 1 | 3 | 51.5 | 0.29 |

### More Veneer

Top 19 mm. thk

|         |          |    |    | L11     | L12     |       |   |   |      |      |
|---------|----------|----|----|---------|---------|-------|---|---|------|------|
| 100x 70 | T1810010 |    |    | 1.120 € | 1.330 € |       | 1 | 3 | 33.4 | 0.17 |
| 110x 80 | T1810011 |    |    | 1.420 € | 1.680 € |       | 1 | 3 | 37.5 | 0.19 |
| 120x 80 | T1810012 | M1 | M1 | 1.590 € | 1.730 € | FM-M2 | 1 | 3 | 38.5 | 0.20 |
| 140x 90 | T1810014 |    |    | 1.760 € | 1.920 € |       | 1 | 3 | 43.4 | 0.24 |
| 160x 90 | T1810016 |    |    | 2.010 € | 2.270 € |       | 1 | 3 | 45.7 | 0.25 |
| 180x 90 | T1810018 |    |    | 2.200 € | 2.530 € |       | 1 | 3 | 51.5 | 0.29 |

### More HPL

Top 10 mm. thk

|         |          |    |    | HH1     | HH2     | HH3     |       |   |   |      |      |
|---------|----------|----|----|---------|---------|---------|-------|---|---|------|------|
| 100x 70 | T1810010 |    |    | 1.170 € | 1.230 € | 1.430 € |       | 1 | 3 | 33.4 | 0.17 |
| 110x 80 | T1810011 |    |    | 1.390 € | 1.450 € | 1.650 € |       | 1 | 3 | 37.5 | 0.19 |
| 120x 80 | T1810012 | M1 | M1 | 1.410 € | 1.480 € | 1.770 € | FM-M2 | 1 | 3 | 38.5 | 0.20 |
| 140x 90 | T1810014 |    |    | 1.470 € | 1.550 € | 1.890 € |       | 1 | 3 | 43.4 | 0.24 |
| 160x 90 | T1810016 |    |    | 1.820 € | 1.970 € | 2.170 € |       | 1 | 3 | 45.7 | 0.25 |
| 180x 90 | T1810018 |    |    | 2.000 € | 2.150 € | 2.330 € |       | 1 | 3 | 51.5 | 0.29 |

**More Glass**

Top 10 mm. thk

|         |          |    |    | GVB     | GVC     | GVD     |       |   |   |      |      |
|---------|----------|----|----|---------|---------|---------|-------|---|---|------|------|
| 100x 70 | T1810010 |    |    | 830 €   | 880 €   | 926 €   |       | 1 | 3 | 50.3 | 0.17 |
| 110x 80 | T1810011 |    |    | 1.030 € | 1.090 € | 1.180 € |       | 1 | 3 | 57.5 | 0.19 |
| 120x 80 | T1810012 |    |    | 1.090 € | 1.240 € | 1.310 € | FM-M2 | 1 | 3 | 59.5 | 0.20 |
| 140x 90 | T1810014 | M1 | M1 | 1.260 € | 1.400 € | 1.520 € |       | 1 | 3 | 68   | 0.24 |
| 160x 90 | T1810016 |    |    | 1.430 € | 1.590 € | 1.760 € |       | 1 | 3 | 76.7 | 0.25 |
| 180x 90 | T1810018 |    |    | 1.600 € | 1.710 € | 1.970 € |       | 1 | 3 | 81.5 | 0.29 |

**More Ceramic**

Top 14 mm. thk

|         |          |    |    | GKA     | GKB     | GMA     |       |   |   |      |      |
|---------|----------|----|----|---------|---------|---------|-------|---|---|------|------|
| 100x 70 | T1810010 |    |    | 1.030 € | 1.100 € | 1.320 € |       | 1 | 3 | 57.4 | 0.17 |
| 110x 80 | T1810011 |    |    | 1.290 € | 1.370 € | 1.530 € |       | 1 | 3 | 65.5 | 0.19 |
| 120x 80 | T1810012 |    |    | 1.390 € | 1.460 € | 1.670 € | FM-M2 | 1 | 3 | 68.5 | 0.20 |
| 140x 90 | T1810014 | M1 | M1 | 1.660 € | 1.730 € | 1.930 € |       | 1 | 3 | 79.4 | 0.24 |
| 160x 90 | T1810016 |    |    | 1.860 € | 1.930 € | 2.100 € |       | 1 | 3 | 89.7 | 0.25 |
| 180x 90 | T1810018 |    |    | 2.020 € | 2.090 € | 2.430 € |       | 1 | 3 | 96.5 | 0.29 |

| Version | Code | Legs | Frame | Top and extensions |  |  | Optional |  |  |  |  |
|---------|------|------|-------|--------------------|--|--|----------|---|---|---|---|
|---------|------|------|-------|--------------------|--|--|----------|---|---|---|---|

**More Melamine HL**

Top and extensions 18 mm thk

|                        |          |    |    | HL1 |         |  |       |   |   |      |      |
|------------------------|----------|----|----|-----|---------|--|-------|---|---|------|------|
| 100/140 x70            | T1811101 |    |    |     | 876 €   |  |       | 1 | 4 | 40   | 0.19 |
| 120/170 x80            | T1811121 |    |    |     | 953 €   |  |       | 1 | 4 | 46   | 0.23 |
| 140/200 x90            | T1811139 |    |    |     | 969 €   |  |       | 1 | 4 | 51   | 0.27 |
| 140/190/240 x90        | T1811141 |    |    |     | 1.330 € |  |       | 1 | 5 | 59.4 | 0.30 |
| 160/220 x90            | T1811160 |    |    |     | 1.350 € |  |       | 1 | 4 | 53.7 | 0.29 |
| 160/210/260 x90        | T1811161 | M1 | M1 |     | 1.680 € |  | FM-M2 | 1 | 5 | 61.7 | 0.31 |
| 180/240 x90            | T1811180 |    |    |     | 1.530 € |  |       | 1 | 4 | 59.5 | 0.33 |
| 180/230/280 x90        | T1811181 |    |    |     | 1.720 € |  |       | 1 | 5 | 67.5 | 0.35 |
| XL 110/155/200/245x 80 | T1813111 |    |    |     | 1.304 € |  |       | 1 | 5 | 55   | 0.28 |
| XL 140/190/240/290x 90 | T1813141 |    |    |     | 1.678 € |  |       | 1 | 6 | 67   | 0.33 |
| XL 160/210/260/310x 90 | T1813161 |    |    |     | 1.790 € |  |       | 1 | 6 | 72   | 0.34 |

**More MDF**

Top and extensions 19 mm thk

|                        |          |    |    | LM1 |         |  |       |   |   |      |      |
|------------------------|----------|----|----|-----|---------|--|-------|---|---|------|------|
| 100/140 x70            | T1811101 |    |    |     | 1.072 € |  |       | 1 | 4 | 40   | 0.19 |
| 120/170 x80            | T1811121 |    |    |     | 1.210 € |  |       | 1 | 4 | 46   | 0.23 |
| 140/200 x90            | T1811139 |    |    |     | 1.461 € |  |       | 1 | 4 | 51   | 0.27 |
| 140/190/240 x90        | T1811141 |    |    |     | 1.730 € |  |       | 1 | 5 | 59.4 | 0.30 |
| 160/220 x90            | T1811160 |    |    |     | 1.790 € |  |       | 1 | 4 | 53.7 | 0.29 |
| 160/210/260 x90        | T1811161 | M1 | M1 |     | 2.085 € |  | FM-M2 | 1 | 5 | 61.7 | 0.31 |
| 180/240 x90            | T1811180 |    |    |     | 2.090 € |  |       | 1 | 4 | 59.5 | 0.33 |
| 180/230/280 x90        | T1811181 |    |    |     | 2.270 € |  |       | 1 | 5 | 67.5 | 0.35 |
| XL 110/155/200/245x 80 | T1813111 |    |    |     | 1.570 € |  |       | 1 | 5 | 55   | 0.28 |
| XL 140/190/240/290x 90 | T1813141 |    |    |     | 1.975 € |  |       | 1 | 6 | 67   | 0.33 |
| XL 160/210/260/310x 90 | T1813161 |    |    |     | 2.101 € |  |       | 1 | 6 | 72   | 0.34 |

**More Veneer**

Top and extensions 19 mm thk

|                        |          |    |    | L11     | L12     |       |   |   |      |      |
|------------------------|----------|----|----|---------|---------|-------|---|---|------|------|
| 100/140 x70            | T1811101 |    |    | 1.650 € | 2.035 € |       | 1 | 4 | 40   | 0.19 |
| 120/170 x80            | T1811121 |    |    | 1.820 € | 2.130 € |       | 1 | 4 | 46   | 0.23 |
| 140/200 x90            | T1811139 |    |    | 2.130 € | 2.530 € |       | 1 | 4 | 51   | 0.27 |
| 140/190/240 x90        | T1811141 |    |    | 2.530 € | 2.930 € |       | 1 | 5 | 59.4 | 0.30 |
| 160/220 x90            | T1811160 |    |    | 2.320 € | 2.730 € |       | 1 | 4 | 53.7 | 0.29 |
| 160/210/260 x90        | T1811161 | M1 | M1 | 2.610 € | 3.030 € | FM-M2 | 1 | 5 | 61.7 | 0.31 |
| 180/240 x90            | T1811180 |    |    | 2.730 € | 3.010 € |       | 1 | 4 | 59.5 | 0.33 |
| 180/230/280 x90        | T1811181 |    |    | 3.120 € | 3.390 € |       | 1 | 5 | 67.5 | 0.35 |
| XL 110/155/200/245x 80 | T1813111 |    |    | 2.510 € | 2.920 € |       | 1 | 5 | 55   | 0.28 |
| XL 140/190/240/290x 90 | T1813141 |    |    | 2.710 € | 3.130 € |       | 1 | 6 | 67   | 0.33 |
| XL 160/210/260/310x 90 | T1813161 |    |    | 2.810 € | 3.090 € |       | 1 | 6 | 72   | 0.34 |

**More HPL**

Top and extensions 10 mm thk

|                        |          |    |    | HH1     | HH2     | HH3     |       |   |   |      |      |
|------------------------|----------|----|----|---------|---------|---------|-------|---|---|------|------|
| 100/140 x70            | T1811101 |    |    | 1.478 € | 1.500 € | 1.730 € |       | 1 | 4 | 40   | 0.19 |
| 120/170 x80            | T1811121 |    |    | 1.760 € | 1.790 € | 2.150 € |       | 1 | 4 | 46   | 0.23 |
| 140/200 x90            | T1811139 |    |    | 2.000 € | 2.030 € | 2.550 € |       | 1 | 4 | 51   | 0.27 |
| 140/190/240 x90        | T1811141 |    |    | 2.270 € | 2.310 € | 2.620 € |       | 1 | 5 | 59.4 | 0.30 |
| 160/220 x90            | T1811160 |    |    | 2.320 € | 2.360 € | 2.530 € |       | 1 | 4 | 53.7 | 0.29 |
| 160/210/260 x90        | T1811161 | M1 | M1 | 2.550 € | 2.620 € | 2.950 € | FM-M2 | 1 | 5 | 61.7 | 0.31 |
| 180/240 x90            | T1811180 |    |    | 2.420 € | 2.480 € | 2.835 € |       | 1 | 4 | 59.5 | 0.33 |
| 180/230/280 x90        | T1811181 |    |    | 2.630 € | 2.690 € | 3.130 € |       | 1 | 5 | 67.5 | 0.35 |
| XL 110/155/200/245x 80 | T1813111 |    |    | 2.700 € | 2.730 € | 2.930 € |       | 1 | 5 | 55   | 0.28 |
| XL 140/190/240/290x 90 | T1813141 |    |    | 2.450 € | 2.490 € | 2.930 € |       | 1 | 6 | 67   | 0.33 |
| XL 160/210/260/310x 90 | T1813161 |    |    | 2.790 € | 2.850 € | 3.330 € |       | 1 | 6 | 72   | 0.34 |

**More Glass**

Glass top 10 mm thk MDF extensions 19 mm thk

|                        |          |    |    | GVB     | GVC     | GVD     |       |   |   |      |      |
|------------------------|----------|----|----|---------|---------|---------|-------|---|---|------|------|
| 100/140 x70            | T1811101 |    |    | 1.029 € | 1.184 € | 1.241 € |       | 1 | 4 | 55.4 | 0.19 |
| 120/170 x80            | T1811121 |    |    | 1.185 € | 1.290 € | 1.380 € |       | 1 | 4 | 65.5 | 0.23 |
| 140/200 x90            | T1811139 |    |    | 1.250 € | 1.360 € | 1.450 € |       | 1 | 4 | 76   | 0.27 |
| 140/190/240 x90        | T1811141 |    |    | 1.910 € | 2.000 € | 2.080 € |       | 1 | 5 | 84   | 0.30 |
| 160/220 x90            | T1811160 |    |    | 1.830 € | 1.930 € | 2.080 € |       | 1 | 4 | 84.7 | 0.29 |
| 160/210/260 x90        | T1811161 | M1 | M1 | 2.125 € | 2.150 € | 2.300 € | FM-M2 | 1 | 5 | 92.7 | 0.31 |
| 180/240 x90            | T1811180 |    |    | 1.880 € | 1.970 € | 2.170 € |       | 1 | 4 | 89.5 | 0.33 |
| 180/230/280 x90        | T1811181 |    |    | 1.990 € | 2.090 € | 2.290 € |       | 1 | 5 | 97.5 | 0.35 |
| XL 110/155/200/245x 80 | T1813111 |    |    | 1.622 € | 1.745 € | 1.916 € |       | 1 | 5 | 75.5 | 0.28 |
| XL 140/190/240/290x 90 | T1813141 |    |    | 2.140 € | 2.291 € | 2.541 € |       | 1 | 6 | 92   | 0.33 |
| XL 160/210/260/310x 90 | T1813161 |    |    | 2.261 € | 2.501 € | 2.735 € |       | 1 | 6 | 99.4 | 0.34 |

**More Ceramic**

Ceramic top 14 mm thk MDF extensions 22 mm thk

|                        |          |    |    | GKA     | GKB     | GMA     |       |   |   |       |      |
|------------------------|----------|----|----|---------|---------|---------|-------|---|---|-------|------|
| 100/140 x70            | T1811101 |    |    | 1.458 € | 1.528 € | 1.663 € |       | 1 | 4 | 62.4  | 0.19 |
| 120/170 x80            | T1811121 |    |    | 1.593 € | 1.687 € | 1.798 € |       | 1 | 4 | 74.5  | 0.23 |
| 140/200 x90            | T1811139 |    |    | 1.699 € | 1.860 € | 1.990 € |       | 1 | 4 | 87.4  | 0.27 |
| 140/190/240 x90        | T1811141 |    |    | 2.230 € | 2.310 € | 2.690 € |       | 1 | 5 | 95.4  | 0.30 |
| 160/220 x90            | T1811160 |    |    | 2.220 € | 2.270 € | 2.770 € |       | 1 | 4 | 97.7  | 0.29 |
| 160/210/260 x90        | T1811161 | M1 | M1 | 2.330 € | 2.425 € | 2.935 € | FM-M2 | 1 | 5 | 105.7 | 0.31 |
| 180/240 x90            | T1811180 |    |    | 2.250 € | 2.300 € | 2.790 € |       | 1 | 4 | 104.5 | 0.33 |
| 180/230/280 x90        | T1811181 |    |    | 2.360 € | 2.420 € | 2.910 € |       | 1 | 5 | 112.5 | 0.35 |
| XL 110/155/200/245x 80 | T1813111 |    |    | 2.076 € | 2.218 € | 2.325 € |       | 1 | 5 | 83.5  | 0.28 |
| XL 140/190/240/290x 90 | T1813141 |    |    | 2.530 € | 2.790 € | 3.120 € |       | 1 | 6 | 103.4 | 0.33 |
| XL 160/210/260/310x 90 | T1813161 |    |    | 2.752 € | 2.872 € | 3.254 € |       | 1 | 6 | 112.4 | 0.34 |

**More Ceramic + extensions HPL**

Ceramic top 14 mm thk HPL extensions

|                        |          |    |    | GKA     | GKB     | GMA     |       |   |   |       |      |
|------------------------|----------|----|----|---------|---------|---------|-------|---|---|-------|------|
| 100/140 x70            | T1818100 |    |    | 1.638 € | 1.708 € | 1.843 € |       | 1 | 4 | 62.4  | 0.19 |
| 120/170 x80            | T1818120 |    |    | 1.783 € | 1.877 € | 2.027 € |       | 1 | 4 | 74.5  | 0.23 |
| 140/200 x90            | T1818140 |    |    | 1.946 € | 2.054 € | 2.214 € |       | 1 | 4 | 87.4  | 0.27 |
| 140/190/240 x90        | T1818141 |    |    | 2.620 € | 2.700 € | 3.020 € |       | 1 | 5 | 95.4  | 0.30 |
| 160/220 x90            | T1818160 |    |    | 2.510 € | 2.560 € | 2.960 € |       | 1 | 4 | 97.7  | 0.29 |
| 160/210/260 x90        | T1818161 | M1 | M1 | 3.080 € | 3.178 € | 3.425 € | FM-M2 | 1 | 5 | 105.7 | 0.31 |
| 180/240 x90            | T1818180 |    |    | 2.720 € | 2.820 € | 3.110 € |       | 1 | 4 | 104.5 | 0.33 |
| 180/230/280 x90        | T1818181 |    |    | 3.320 € | 3.410 € | 3.635 € |       | 1 | 5 | 112.5 | 0.35 |
| XL 110/155/200/245x 80 | T1819110 |    |    | 2.310 € | 2.410 € | 2.610 € |       | 1 | 5 | 83.5  | 0.28 |
| XL 140/190/240/290x 90 | T1819140 |    |    | 3.168 € | 3.424 € | 3.717 € |       | 1 | 6 | 103.4 | 0.33 |
| XL 160/210/260/310x 90 | T1819160 |    |    | 3.342 € | 3.462 € | 3.844 € |       | 1 | 6 | 112.4 | 0.34 |

**Note:**

For Glass or Crystal Ceramic tops, extensions Only in MDF or HPL

**Frame finishes**

| Metal     |   |
|-----------|---|
| <b>MI</b> | WHITE <b>BB</b> , BROWN <b>E6</b> , SAND <b>EC</b> , WHITE PEARL <b>EF</b> , GRAPHITE <b>EG</b> , BLACK <b>EN</b> |

**Legs finishes**

| Metal     |   |
|-----------|---|
| <b>MI</b> | WHITE <b>BB</b> , BROWN <b>E6</b> , SAND <b>EC</b> , WHITE PEARL <b>EF</b> , GRAPHITE <b>EG</b> , BLACK <b>EN</b> |

**Top and extensions finishes**

**Melamine**

|            |  |
|------------|--|
| <b>HL1</b> | WHITE <b>M01</b> , GRAFITE <b>M02</b> , BLACK <b>M04</b> , SAND <b>M07</b> |
|------------|--|

**HPL**

|            |  |
|------------|--|
| <b>HH1</b> | WHITE/Black Core <b>HB4</b> , BLACK/Black Core <b>HN4</b>  |
| <b>HH2</b> | CEMENT/Black Core <b>HC6</b> , CORTEN/Brown Core <b>HC7</b> , DARK GREY/Black Core <b>HGW</b>  |
| <b>HH3</b> | ST WHITE/White Core <b>AB4</b> , ST SAND/Sand Core <b>ACR</b> , ST GRAPHITE GREY/ Grafite Core <b>AGD</b> , ST BLACK/Black Core <b>AN4</b> , ST TORTORA/Tortora Core <b>ATR</b> , ST RED NAMIB/Red Core <b>FAM</b> , ST YELLOW EVORA/Yellow Core <b>FGO</b> , ST RED BULGARO/Red Core <b>FRB</b> , ST GREEN KITAMI/Green Core <b>FVK</b> |

**Lacquared MDF**

|            |   |
|------------|---|
| <b>LMI</b> | GRAPHITE GREY <b>G02</b> , BLACK <b>G04</b> , WHITE <b>G05</b> , SAND <b>G07</b> , BROWN <b>G41</b> |
|------------|---|

**Veneer**

|            |  |
|------------|--|
| <b>LI1</b> | Stained BLACK <b>I04</b> , Stained WHITE <b>I05</b> , Stained CHERRY RED <b>I09</b> , Stained DARK BROWN <b>I26</b> , Stained NATURAL <b>I40</b> , Stained NATURAL OAK <b>I52</b> , Stained WHITENED <b>I60</b> , Stained DESERT <b>I61</b> , Stained LIGHT GREY <b>I62</b> , Stained DARK GREY <b>I63</b> |
| <b>LI2</b> | NATURAL OAK <b>I22</b> , FLAMED WALNUT <b>I24</b>  |

**Top finishes**

**Glass**

|            |   |
|------------|---|
| <b>GVC</b> | MATT GRAFITE ANTISCRATCH <b>J31</b> , MATT SAND ANTISCRATCH <b>J32</b>  |
| <b>GVD</b> | EXTRA CLEAR MATT WHITE ANTISCRATCH <b>J41</b>   |
| <b>GVB</b> | EXTRA CLEAR GLOSSY WHITE <b>J21</b> , EXTRA CLEAR GLOSSY CHERRY RED <b>J25</b> , EXTRA CLEAR GLOSSY BLUE SAPPHIRE <b>J26</b> , EXTRA CLEAR GLOSSY BLUE TURQUOISE <b>J27</b> |

**Crystal Ceramic and Ceramic**

|            |   |
|------------|---|
| <b>GKA</b> | CHARCOAL SAVOIA <b>K11</b> , CEMENT SAVOIA <b>K12</b>   |
| <b>GKB</b> | WHITE CALCE <b>K24</b> , BLACK CALCE <b>K25</b> , TORTORA CALCE <b>K26</b> , PIASENTINA STONE TAUPE Materica <b>K55</b> , TERRACOTTA Matt <b>K90</b> , MATT GREEN <b>K91</b>  |
| <b>GMA</b> | MARBLE CALACATTA GLOSSY WHITE <b>K32</b> , BLACK GREEK MARBLE <b>K33</b> , MARBLE GLOSSY NOIR DESIR <b>K35</b> , MARBLE CALACATTA MATT WHITE <b>K42</b> , MARBLE MATT NOIR DESIR <b>K45</b> , MARBLE MATT GREEN TINOS <b>K46</b> , MARBLE STATUARIO WHITE MATT <b>K47</b> , MARBLE CALACAT BLACK Bush Hammered <b>K50</b> |

**Optionals:**

|              |                      | Value   | Options/notes  |
|--------------|----------------------|---------|--|
| <b>FM-M2</b> | Indoor matt metal M2 | + 180 € | ASH GREY <b>ES</b> , BLUE SAPPHIRE <b>EE</b> , BLUE TURQUOISE <b>EH</b> , BRONZE <b>E2</b> , BULGARO RED <b>FP</b> , CHERRY RED <b>EQ</b> , DARK GREEN <b>EL</b> , FACEPOWDER PINK <b>E8</b> , FANGO <b>E3</b> , GOLDEN YELLOW <b>EO</b> , LIGHT BLUE <b>EO</b> , LIGHT GREY <b>ET</b> , OCEAN BLUE <b>E1</b> , OCHER YELLOW <b>E7</b> , PAPAYA ORANGE <b>EA</b> , PASTEL YELLOW <b>E4</b> , PINE GREEN <b>EJ</b> , RED <b>ER</b> , SAGE GREEN <b>E9</b> |

**100x70**

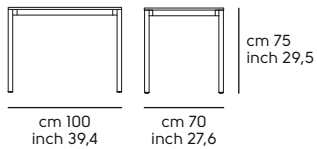

**110x80**

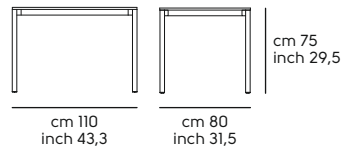

**120x80**

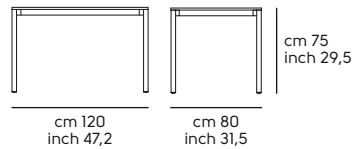

**140x90**

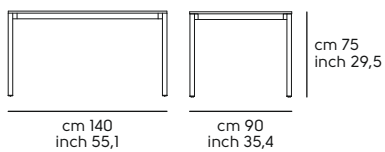

**160x90**

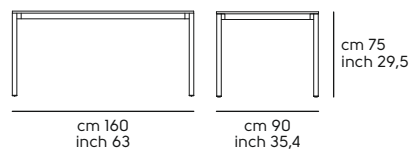

**180x90**

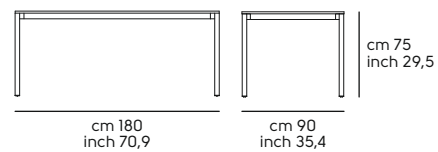

**100/140x70**

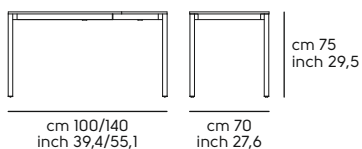

**120/170x80**

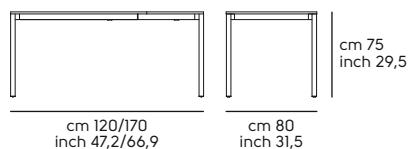

**140/200x90**

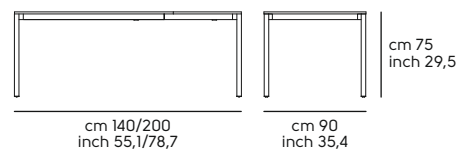

**140/190/240x90**

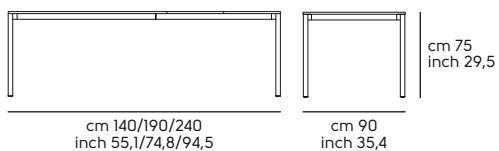

**160/220x90**

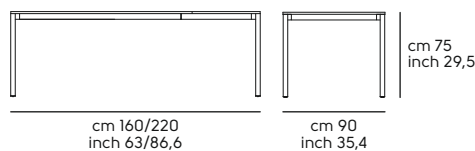

**160/210/260x90**

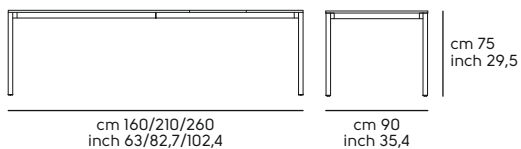

**180/240x90**

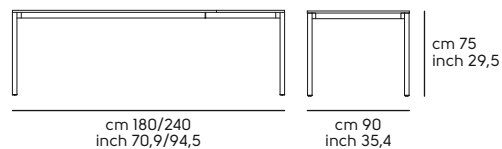

**180/230/280x90**

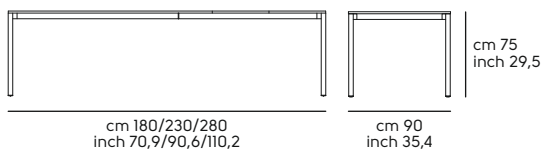

**XL 110/155/200/245x80**

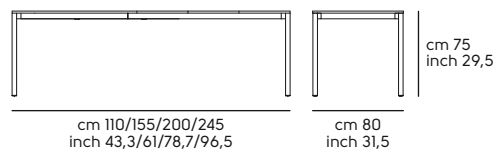

**XL 140/190/240/290x90**

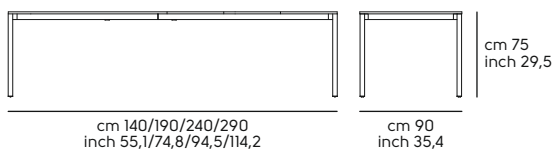

**XL 160/210/260/310x90**

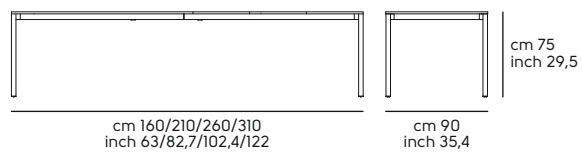

# Nenè design Paolo Vernier

## Table Nenè

Frame in: metal



T  
A  
B  
L  
E  
S

| Version                 | Code     | Legs | Frame | Top   | Optional | Q.ty | boxes | Kg   | M <sup>3</sup> |
|-------------------------|----------|------|-------|-------|----------|------|-------|------|----------------|
| <b>Nenè Melamine HL</b> |          |      |       |       |          |      |       |      |                |
| Top 18 mm. thk          |          |      |       |       |          |      |       |      |                |
|                         |          |      |       | HL1   |          |      |       |      |                |
| D. 70                   | T1370D07 |      |       | 453 € |          | 1    | 3     | 16.5 | 0.25           |
| D. 80                   | T1370D08 |      |       | 480 € |          | 1    | 3     | 19.5 | 0.25           |
| Triangular              | T1370T01 | MI   | MI    | 560 € | FM-M2    | 1    | 3     | 19.5 | 0.28           |
| 75 x75                  | T1370075 |      |       | 553 € |          | 1    | 3     | 22.5 | 0.29           |
| 85 x85                  | T1370085 |      |       | 570 € |          | 1    | 3     | 22.5 | 0.29           |
| 140x90                  | T1370140 |      |       | 739 € |          | 1    | 3     | 32   | 0.29           |

## Nenè HPL

Top 10 mm. thk

|            |          |    |    | HH1   | HH2   | HH3   |       |   |   |      |      |
|------------|----------|----|----|-------|-------|-------|-------|---|---|------|------|
| D. 70      | T1370D07 |    |    | 616 € | 653 € | 676 € |       | 1 | 3 | 16.5 | 0.25 |
| D. 80      | T1370D08 |    |    | 631 € | 669 € | 691 € |       | 1 | 3 | 19.5 | 0.25 |
| Triangular | T1370T01 | MI | MI | 639 € | 675 € | 703 € | FM-M2 | 1 | 3 | 19.5 | 0.28 |
| 75 x75     | T1370075 |    |    | 691 € | 720 € | 757 € |       | 1 | 3 | 22.5 | 0.29 |
| 85 x85     | T1370085 |    |    | 756 € | 795 € | 883 € |       | 1 | 3 | 22.5 | 0.29 |

### Note:

75x75 / 85x85 stackable table x 4

**Frame finishes**

**Metal**

|           |   |
|-----------|---|
| <b>MI</b> | WHITE <b>BB</b> , BROWN <b>E6</b> , SAND <b>EC</b> , WHITE PEARL <b>EF</b> , GRAPHITE <b>EG</b> , BLACK <b>EN</b> |
|-----------|---|

**Legs finishes**

**Metal**

|           |   |
|-----------|---|
| <b>MI</b> | WHITE <b>BB</b> , BROWN <b>E6</b> , SAND <b>EC</b> , WHITE PEARL <b>EF</b> , GRAPHITE <b>EG</b> , BLACK <b>EN</b> |
|-----------|---|

**Top finishes**

**Melamine**

|            |  |
|------------|--|
| <b>HLI</b> | WHITE <b>M01</b> , GRAFITE <b>M02</b> , BLACK <b>M04</b> , SAND <b>M07</b> |
|------------|--|

**HPL**

|            |  |
|------------|--|
| <b>HH1</b> | WHITE/Black Core <b>HB4</b> , BLACK/Black Core <b>HN4</b>  |
| <b>HH2</b> | CEMENT/Black Core <b>HC6</b> , CORTEN/Brown Core <b>HC7</b> , DARK GREY/Black Core <b>HGW</b>  |
| <b>HH3</b> | ST WHITE/White Core <b>AB4</b> , ST SAND/Sand Core <b>ACR</b> , ST GRAPHITE GREY/ Grafite Core <b>AGD</b> , ST BLACK/Black Core <b>AN4</b> , ST TORTORA/Tortora Core <b>ATR</b> , ST RED NAMIB/Red Core <b>FAM</b> , ST YELLOW EVORA/Yellow Core <b>FGO</b> , ST RED BULGARO/Red Core <b>FRB</b> , ST GREEN KITAMI/Green Core <b>FVK</b> |

**Optionals:**

|              |                      | Value   | Options/notes  |
|--------------|----------------------|---------|--|
| <b>FM-M2</b> | Indoor matt metal M2 | + 164 € | ASH GREY <b>ES</b> , BLUE SAPPHIRE <b>EE</b> , BLUE TURQUOISE <b>EH</b> , BRONZE <b>E2</b> , BULGARO RED <b>FP</b> , CHERRY RED <b>EQ</b> , DARK GREEN <b>EL</b> , FACEPOWDER PINK <b>E8</b> , FANGO <b>E3</b> , GOLDEN YELLOW <b>EO</b> , LIGHT BLUE <b>EO</b> , LIGHT GREY <b>ET</b> , OCEAN BLUE <b>EI</b> , OCHER YELLOW <b>E7</b> , PAPAYA ORANGE <b>EA</b> , PASTEL YELLOW <b>E4</b> , PINE GREEN <b>EJ</b> , RED <b>ER</b> , SAGE GREEN <b>E9</b> |

**D. 70**

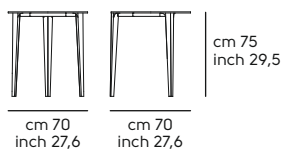

**D. 80**

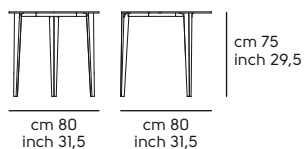

**Triangular**

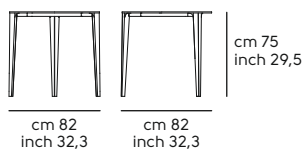

**75 x75**

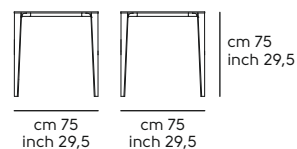

**85 x85**

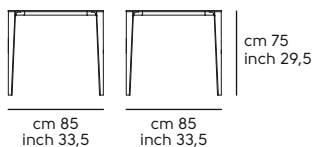

**140x90**

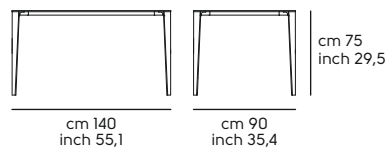

# Nexus design Andrea Lucatello

## Table Nexus

Frame in: baydur



| Version | Code | -- | Frame | Top | Optional | Q.ty | boxes | Kg | M <sup>3</sup> |
|---------|------|----|-------|-----|----------|------|-------|----|----------------|
|---------|------|----|-------|-----|----------|------|-------|----|----------------|

### Nexus Glass

Top 15 mm. thk

|                    |          |  |     | GVB     |       |   |   |     |      |
|--------------------|----------|--|-----|---------|-------|---|---|-----|------|
| 220x116 Barrel     | T1834220 |  |     | 3.233 € |       | 1 | 2 | 120 | 1.18 |
| 250x120 Barrel     | T1834250 |  | PBI | 3.747 € | FP-B2 | 1 | 2 | 130 | 1.20 |
| 280x120 Elliptical | T1836280 |  |     | 4.044 € |       | 1 | 2 | 135 | 1.30 |

### Nexus Ceramic

Top 16 mm. thk

|                    |          |  |     | GMA     |       |   |   |     |      |
|--------------------|----------|--|-----|---------|-------|---|---|-----|------|
| 220x116 Barrel     | T1834220 |  |     | 4.863 € |       | 1 | 2 | 145 | 1.18 |
| 250x120 Barrel     | T1834250 |  | PBI | 5.104 € | FP-B2 | 1 | 2 | 160 | 1.20 |
| 280x120 Elliptical | T1836280 |  |     | 5.397 € |       | 1 | 2 | 165 | 1.30 |

### Nexus wood

Top 40 mm. thk

|            |          |  |     | LS1     | LS2     |       |   |   |     |      |
|------------|----------|--|-----|---------|---------|-------|---|---|-----|------|
| LG 250x106 | T1830250 |  | PBI | 4.635 € | 4.953 € | FP-B2 | 1 | 2 | 115 | 1.10 |

**Frame finishes**

**Baydur**

|            |   |
|------------|---|
| <b>PBI</b> | WHITE <b>BB4</b> , ASH GREY <b>BGS</b> , DARK GREY <b>BGW</b> |
|------------|---|

**Top finishes**

**Solid ashwood**

|            |                                   |
|------------|-----------------------------------|
| <b>LS1</b> | IM OAK STRAIGHT EDGE <b>WR1</b>   |
| <b>LS2</b> | SOLID WALNUT BARK EDGE <b>WN1</b> |

**Glossy Glass**

|            |                                    |
|------------|------------------------------------|
| <b>GVB</b> | EXTRA CLEAR TRANSPARENT <b>J01</b> |
|------------|------------------------------------|

**Crystal Ceramic and Ceramic**

|            |   |
|------------|---|
| <b>GMA</b> | MARBLE CALACATTA GLOSSY WHITE <b>K32</b> , BLACK GREEK MARBLE <b>K33</b> , MARBLE GLOSSY NOIR DESIR <b>K35</b> , MARBLE CALACATTA MATT WHITE <b>K42</b> , MARBLE MATT NOIR DESIR <b>K45</b> , MARBLE MATT GREEN TINOS <b>K46</b> , MARBLE STATUARIO WHITE MATT <b>K47</b> , MARBLE CALACAT BLACK Bush Hammered <b>K50</b> |
|------------|---|

**Optionals:**

|              |            | Value   | Options/notes  |
|--------------|------------|---------|--|
| <b>FP-B2</b> | Baydur PB2 | + 895 € | BRUSHED CONCRETE DARK GREY <b>CGW</b> , BRUSHED CONCRETE LIGHT GREY <b>CGT</b> |

**220x116 Barrel**

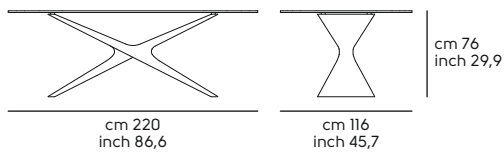

**250x120 Barrel**

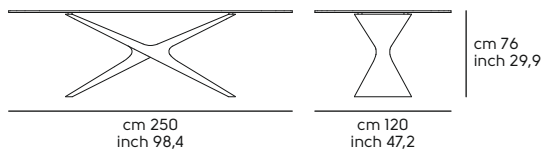

**280x120 Elliptical**

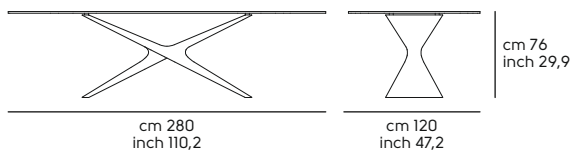

**LG 250x106**

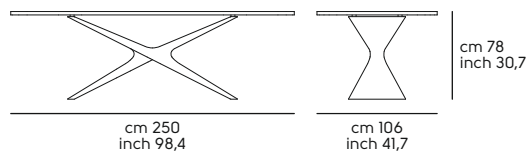

# Paul design Officina delle Idee

## Table Paul

Frame in: metal



| Version | Code | Legs | Frame | Top and extensions | Optional | Q.ty | boxes | Kg | M <sup>3</sup> |
|---------|------|------|-------|--------------------|----------|------|-------|----|----------------|
|---------|------|------|-------|--------------------|----------|------|-------|----|----------------|

### Paul Veneer

Top and extensions 20 mm thk

|                      |          |    |    | L11     | L12     |       |   |   |     |      |
|----------------------|----------|----|----|---------|---------|-------|---|---|-----|------|
| D. 120/180           | T1970D12 |    |    | 2.315 € | 2.429 € | FM-M2 | 1 | 2 | 105 | 0.87 |
| 120/180x120 - Barrel | T1970I20 | MI | MI | 2.268 € | 2.348 € |       | 1 | 2 | 110 | 0.90 |

### Paul Ceramic

Top 14 mm. thk

|                      |          |    |    | GKA     | GKB     |       |   |   |     |      |
|----------------------|----------|----|----|---------|---------|-------|---|---|-----|------|
| D. 120/180           | T1970D12 |    |    | 3.499 € | 3.622 € | FM-M2 | 1 | 2 | 130 | 0.87 |
| 120/180x120 - Barrel | T1970I20 | MI | MI | 3.492 € | 3.621 € |       | 1 | 2 | 135 | 0.90 |

### Note:

For Glass or Crystal Ceramic tops, extensions in the same material

### Frame finishes

#### Metal

|           |   |
|-----------|---|
| <b>MI</b> | WHITE <b>BB</b> , BROWN <b>E6</b> , SAND <b>EC</b> , WHITE PEARL <b>EF</b> , GRAPHITE <b>EG</b> , BLACK <b>EN</b> |
|-----------|---|

### Legs finishes

#### Metal

|           |   |
|-----------|---|
| <b>MI</b> | WHITE <b>BB</b> , BROWN <b>E6</b> , SAND <b>EC</b> , WHITE PEARL <b>EF</b> , GRAPHITE <b>EG</b> , BLACK <b>EN</b> |
|-----------|---|

### Top and extensions finishes

#### Veneer

|            |   |
|------------|---|
| <b>L11</b> | Stained BLACK <b>I04</b> , Stained WHITE <b>I05</b> , Stained NATURAL <b>I40</b> , Stained WHITENED <b>I60</b> , Stained DESERT <b>I61</b> , Stained LIGHT GREY <b>I62</b> , Stained DARK GREY <b>I63</b> |
| <b>L12</b> | NATURAL OAK <b>I22</b> , FLAMED WALNUT <b>I24</b>   |

#### Crystal Ceramic and Ceramic

|            |  |
|------------|--|
| <b>GKA</b> | CHARCOAL SAVOIA <b>K11</b> , CEMENT SAVOIA <b>K12</b>                      |
| <b>GKB</b> | WHITE CALCE <b>K24</b> , BLACK CALCE <b>K25</b> , TORTORA CALCE <b>K26</b> |

### Optionals:

|              | Value   | Options/notes  |
|--------------|---------|--|
| <b>FM-M2</b> | + 164 € | Indoor matt metal M2<br>ASH GREY <b>ES</b> , BLUE SAPPHIRE <b>EE</b> , BLUE TURQUOISE <b>EH</b> , BRONZE <b>E2</b> , BULGARO RED <b>FP</b> , CHERRY RED <b>EQ</b> , DARK GREEN <b>EL</b> , FACEPOWDER PINK <b>E8</b> , FANGO <b>E3</b> , GOLDEN YELLOW <b>EO</b> , LIGHT BLUE <b>EO</b> , LIGHT GREY <b>ET</b> , OCEAN BLUE <b>E1</b> , OCHER YELLOW <b>E7</b> , PAPAYA ORANGE <b>EA</b> , PASTEL YELLOW <b>E4</b> , PINE GREEN <b>EJ</b> , RED <b>ER</b> , SAGE GREEN <b>E9</b> |

### D. 120/180

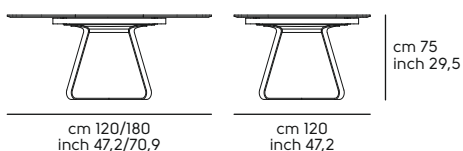

### 120/180x120 - Barrel

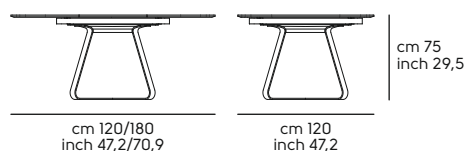

# Pechino design Studio Kappa

## Table Pechino

Frame in: metal



| Version | Code | Legs | Frame | Top | Optional | Q.ty | boxes | Kg | M <sup>3</sup> |
|---------|------|------|-------|-----|----------|------|-------|----|----------------|
|---------|------|------|-------|-----|----------|------|-------|----|----------------|

### Pechino Veneer

Top 19 mm. thk

|         |          |    |    | LI1     |       |   |   |     |      |
|---------|----------|----|----|---------|-------|---|---|-----|------|
| 200x106 | T0260200 | M1 | M1 | 1.924 € | FM-M2 | 1 | 3 | 153 | 1.14 |
| 250x106 | T0260250 |    |    | 2.217 € |       | 1 | 3 | 181 | 1.13 |

### Pechino wood

Top 40 mm. thk

|         |          |    |    | LS1     | LS2     |       |   |   |     |      |
|---------|----------|----|----|---------|---------|-------|---|---|-----|------|
| 200x106 | T0260200 | M1 | M1 | 3.491 € | 3.610 € | FM-M2 | 1 | 3 | 168 | 1.14 |
| 250x106 | T0260250 |    |    | 3.782 € | 3.903 € |       | 1 | 3 | 168 | 1.24 |

### Pechino Glass

Top 12 mm. thk

|         |          |    |    | GVB     | GVC     | GVD     |       |   |   |     |      |
|---------|----------|----|----|---------|---------|---------|-------|---|---|-----|------|
| 200x106 | T0260200 | M1 | M1 | 2.322 € | 2.722 € | 3.080 € | FM-M2 | 1 | 2 | 153 | 1.03 |
| 250x106 | T0260250 |    |    | --      | 3.119 € | 3.517 € |       | 1 | 3 | 181 | 1.13 |

### Note:

Glass Top 250x106 NO GVB

**Frame finishes**

|              |   |
|--------------|---|
| <b>Metal</b> |   |
| <b>M1</b>    | WHITE <b>BB</b> , BROWN <b>E6</b> , SAND <b>EC</b> , WHITE PEARL <b>EF</b> , GRAPHITE <b>EG</b> , BLACK <b>EN</b> |

**Legs finishes**

|              |   |
|--------------|---|
| <b>Metal</b> |   |
| <b>M1</b>    | WHITE <b>BB</b> , BROWN <b>E6</b> , SAND <b>EC</b> , WHITE PEARL <b>EF</b> , GRAPHITE <b>EG</b> , BLACK <b>EN</b> |

**Top finishes**

|               |   |
|---------------|---|
| <b>Veneer</b> |   |
| <b>L11</b>    | Stained BLACK <b>I04</b> , Stained DARK BROWN <b>I26</b> , Stained WHITENED <b>I60</b> , Stained DESERT <b>I61</b> , Stained LIGHT GREY <b>I62</b> , Stained DARK GREY <b>I63</b> |

|                      |                                   |
|----------------------|-----------------------------------|
| <b>Solid ashwood</b> |                                   |
| <b>LS1</b>           | IM OAK STRAIGHT EDGE <b>WR1</b>   |
| <b>LS2</b>           | SOLID WALNUT BARK EDGE <b>WN1</b> |

**Glossy Glass**

|            |                                    |
|------------|------------------------------------|
| <b>GVB</b> | EXTRA CLEAR TRANSPARENT <b>J01</b> |
|------------|------------------------------------|

**Top and extensions finishes**

**Satin Glass**

|            |  |
|------------|--|
| <b>GVC</b> | MATT GRAFITE ANTISCRATCH <b>J31</b> , MATT SAND ANTISCRATCH <b>J32</b> |
| <b>GVD</b> | EXTRA CLEAR MATT WHITE ANTISCRATCH <b>J41</b>                          |

**Optionals:**

|              |                      | Value   | Options/notes  |
|--------------|----------------------|---------|--|
| <b>FM-M2</b> | Indoor matt metal M2 | + 164 € | ASH GREY <b>ES</b> , BLUE SAPPHIRE <b>EE</b> , BLUE TURQUOISE <b>EH</b> , BRONZE <b>E2</b> , BULGARO RED <b>FP</b> , CHERRY RED <b>EQ</b> , DARK GREEN <b>EL</b> , FACEPOWDER PINK <b>E8</b> , FANGO <b>E3</b> , GOLDEN YELLOW <b>EO</b> , LIGHT BLUE <b>EO</b> , LIGHT GREY <b>ET</b> , OCEAN BLUE <b>E1</b> , OCHER YELLOW <b>E7</b> , PAPAYA ORANGE <b>EA</b> , PASTEL YELLOW <b>E4</b> , PINE GREEN <b>EJ</b> , RED <b>ER</b> , SAGE GREEN <b>E9</b> |

**200x106**

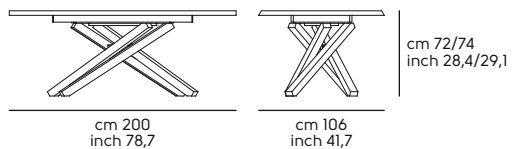

**250x106**

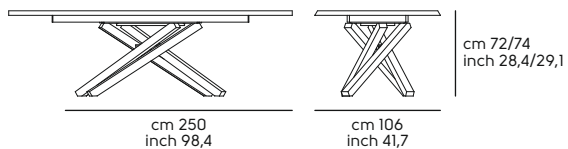

# Planum design Studio Pastina

## Table Planum

Frame in: ashwood



| Version | Code | Legs | Frame | Top | Optional | Q.ty | boxes | Kg | M <sup>3</sup> |
|---------|------|------|-------|-----|----------|------|-------|----|----------------|
|---------|------|------|-------|-----|----------|------|-------|----|----------------|

### Planum Veneer

Top 16 mm. thk

|         |          |     |     | LII     |  |   |   |      |      |
|---------|----------|-----|-----|---------|--|---|---|------|------|
| 140x140 | T2320140 |     |     | 3.980 € |  | 1 | 3 | 65.5 | 0.78 |
| 160x90  | T2320160 |     |     | 3.950 € |  | 1 | 3 | 57.5 | 0.57 |
| 180x100 | T2320180 | LFI | LFI | 4.150 € |  | 1 | 3 | 64.5 | 0.67 |
| 220x100 | T2320220 |     |     | 4.350 € |  | 1 | 3 | 74.0 | 0.77 |

| Version | Code | Legs | Frame | Top | Optional | Q.ty | boxes | Kg | M <sup>3</sup> |
|---------|------|------|-------|-----|----------|------|-------|----|----------------|
|---------|------|------|-------|-----|----------|------|-------|----|----------------|

### Planum Glass

Top 12 mm. thk

|         |          |     |     | GVB     | GVC     | GVD     |  |   |   |      |      |
|---------|----------|-----|-----|---------|---------|---------|--|---|---|------|------|
| 140x140 | T2320140 |     |     | 3.937 € | 4.111 € | 4.269 € |  | 1 | 3 | 104  | 0.78 |
| 160x90  | T2320160 |     |     | 3.621 € | 3.784 € | 3.830 € |  | 1 | 3 | 85.5 | 0.57 |
| 180x100 | T2320180 | LFI | LFI | 3.790 € | 3.968 € | 4.178 € |  | 1 | 3 | 99.5 | 0.67 |
| 220x100 | T2320220 |     |     | 4.202 € | 4.350 € | 4.570 € |  | 1 | 3 | 117  | 0.77 |

| Version | Code | Legs | Frame | Top | Optional | Q.ty | boxes | Kg | M <sup>3</sup> |
|---------|------|------|-------|-----|----------|------|-------|----|----------------|
|---------|------|------|-------|-----|----------|------|-------|----|----------------|

### Planum Ceramic

Top 12 mm. thk

|         |          |     |     | GKA     | GKB     | GMA     |  |   |   |       |      |
|---------|----------|-----|-----|---------|---------|---------|--|---|---|-------|------|
| 140x140 | T2320140 |     |     | --      | --      | 4.957 € |  | 1 | 3 | 109   | 0.78 |
| 160x90  | T2320160 |     |     | 4.218 € | 4.243 € | 4.927 € |  | 1 | 3 | 93    | 0.57 |
| 180x100 | T2320180 | LFI | LFI | 4.539 € | 4.580 € | 5.263 € |  | 1 | 3 | 106.5 | 0.67 |
| 220x100 | T2320220 |     |     | 4.814 € | 4.865 € | 5.488 € |  | 1 | 3 | 124   | 0.77 |

### Note:

For 140x140 NO GMA MARBLE CALACATTA WHITE Mat [K42]

| Version | Code | Legs | Frame | Top | Optional | Q.ty | boxes | Kg | M <sup>3</sup> |
|---------|------|------|-------|-----|----------|------|-------|----|----------------|
|---------|------|------|-------|-----|----------|------|-------|----|----------------|

### Planum Marble

Top 20 mm. thk

|         |          |     |     | GMM     |  |   |   |       |      |
|---------|----------|-----|-----|---------|--|---|---|-------|------|
| 140x140 | T2320140 |     |     | 6.385 € |  | 1 | 3 | 158.5 | 0.78 |
| 160x90  | T2320160 |     |     | 5.681 € |  | 1 | 3 | 129.5 | 0.57 |
| 180x100 | T2320180 | LFI | LFI | 6.283 € |  | 1 | 3 | 152   | 0.67 |
| 220x100 | T2320220 |     |     | 6.790 € |  | 1 | 3 | 178.5 | 0.77 |

**Legs and Frame finishes**

**Wood**

|            |  |
|------------|--|
| <b>LFI</b> | Ash wood stained BLACK <b>F04</b> , Ash wood stained WHITE <b>F05</b> , Ash wood stained CHERRY RED <b>F09</b> , Ash wood stained FLAMED WALNUT <b>F24</b> , Ash wood stained DARK BROWN <b>F26</b> , Ash wood stained NATURAL <b>F40</b> , Ash wood stained NATURAL OAK <b>F52</b> , Ash wood stained WHITENED <b>F60</b> , Ash wood stained DESERT <b>F61</b> , Ash wood stained LIGHT GREY <b>F62</b> , Ash wood stained DARK GREY <b>F63</b> |
|------------|--|

**Top finishes**

**Veneer**

|            |  |
|------------|--|
| <b>LII</b> | Stained BLACK <b>I04</b> , Stained WHITE <b>I05</b> , Stained WHITENED <b>I60</b> , Stained DESERT <b>I61</b> , Stained LIGHT GREY <b>I62</b> , Stained DARK GREY <b>I63</b> |
|------------|--|

**Satin Glass**

|            |  |
|------------|--|
| <b>GVC</b> | MATT GRAFITE ANTISCRATCH <b>J31</b> , MATT SAND ANTISCRATCH <b>J32</b> |
| <b>GVD</b> | EXTRA CLEAR MATT WHITE ANTISCRATCH <b>J41</b>                          |

**Marble**

|            |   |
|------------|---|
| <b>GMM</b> | BEIGE TRAVERTINO ROMANO <b>MB2</b> , WHITE CALACATTA VAGLI <b>MB4</b> , BLACK MARQUINIA <b>MN4</b> , GREEN TINOS <b>MVE</b> |
|------------|---|

**Glossy Glass**

|            |   |
|------------|---|
| <b>GVB</b> | EXTRA CLEAR GLOSSY WHITE <b>J21</b> , EXTRA CLEAR GLOSSY CHERRY RED <b>J25</b> , EXTRA CLEAR GLOSSY BLUE SAPPHIRE <b>J26</b> , EXTRA CLEAR GLOSSY BLUE TURQUOISE <b>J27</b> |
|------------|---|

**Ceramic**

|            |  |
|------------|--|
| <b>GKA</b> | CHARCOAL SAVOIA <b>K11</b> , CEMENT SAVOIA <b>K12</b>  |
| <b>GKB</b> | WHITE CALCE <b>K24</b> , BLACK CALCE <b>K25</b> , TORTORA CALCE <b>K26</b> , PIASENTINA STONE TAUPE Materica <b>K55</b>  |
| <b>GMA</b> | MARBLE CALACATTA GLOSSY WHITE <b>K32</b> , BLACK GREEK MARBLE <b>K33</b> , MARBLE GLOSSY NOIR DESIR <b>K35</b> , MARBLE MATT NOIR DESIR <b>K45</b> , MARBLE MATT GREEN TINOS <b>K46</b> , MARBLE STATUARIO WHITE MATT <b>K47</b> , MARBLE CALACAT BLACK Bush Hammered <b>K50</b> |

**140x140**

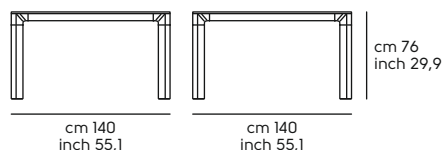

**160x90**

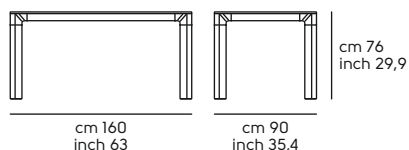

**180x100**

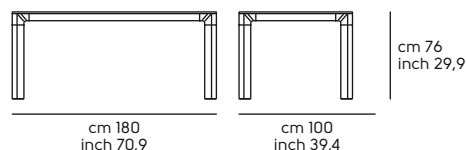

**220x100**

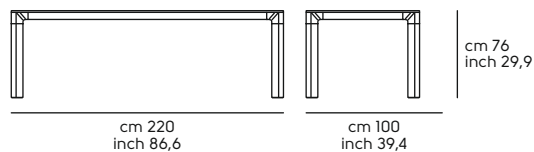

# Plissé design Paola Navone

## Table Plissé

Frame in: metal



| Version | Code | Frame | -- | Top | Optional | Q.ty | boxes | Kg | M <sup>3</sup> |
|---------|------|-------|----|-----|----------|------|-------|----|----------------|
|---------|------|-------|----|-----|----------|------|-------|----|----------------|

### Plissé Veneer

Top Ø150 20 mm thk - Ø180 25 mm thk

|        |          |    |  | L11     | L12     |       |   |   |     |      |
|--------|----------|----|--|---------|---------|-------|---|---|-----|------|
| D. 150 | T2220150 | M1 |  | 2.490 € | 2.580 € | FM-M2 | 1 | 3 | 84  | 0.8  |
| D. 180 | T2220180 |    |  | 3.084 € | 3.524 € |       | 1 | 3 | 114 | 0.82 |

### Plissé HPL

Top 10 mm. thk

|        |          |    |  | HH3     |  |       |   |   |    |     |
|--------|----------|----|--|---------|--|-------|---|---|----|-----|
| D. 150 | T2220150 | M1 |  | 3.380 € |  | FM-M2 | 1 | 3 | 84 | 0.8 |

### Plissé Glass

Top 10 mm. thk

|        |          |    |  | GVB     | GVC     | GVD     |       |   |   |     |     |
|--------|----------|----|--|---------|---------|---------|-------|---|---|-----|-----|
| D. 150 | T2220150 | M1 |  | 3.219 € | 3.254 € | 3.315 € | FM-M2 | 1 | 3 | 119 | 0.8 |

### Plissé Ceramic

Top 16 mm. thk

|        |          |    |  | GMA     |  |       |   |   |     |     |
|--------|----------|----|--|---------|--|-------|---|---|-----|-----|
| D. 150 | T2220150 | M1 |  | 3.406 € |  | FM-M2 | 1 | 3 | 132 | 0.8 |

### Plissé Marble

Top 20 mm. thk

|        |          |    |  | GMM     |  |       |   |   |     |      |
|--------|----------|----|--|---------|--|-------|---|---|-----|------|
| D. 150 | T2220150 | M1 |  | 5.050 € |  | FM-M2 | 1 | 3 | 159 | 0.8  |
| D. 180 | T2220180 |    |  | 6.223 € |  |       | 1 | 3 | 203 | 0.82 |

### Note:

Marble Top D.180 available only BLACK MARQUINIA [MN4] and WHITE CALACATTA VAGLI [MB4] - Top D.150 NOT available in GMA K46

### Optionals:

|              |                      | Value   | Options/notes   |
|--------------|----------------------|---------|---|
| <b>FM-M2</b> | Indoor matt metal M2 | + 122 € | ASH GREY <b>ES</b> , BLUE SAPPHIRE <b>EE</b> , BLUE TURQUOISE <b>EH</b> , BRONZE <b>EZ</b> + TRANSP., BULGARO RED <b>FP</b> , CHERRY RED <b>EQ</b> , DARK GREEN <b>EL</b> , FACEPOWDER PINK <b>E8</b> , FANGO <b>E3</b> , GOLDEN YELLOW <b>EO</b> , LIGHT BLUE <b>EO</b> , LIGHT GREY <b>ET</b> , OCEAN BLUE <b>E1</b> , OCHER YELLOW <b>E7</b> , PAPAYA ORANGE <b>EA</b> , PASTEL YELLOW <b>E4</b> , PINE GREEN <b>EJ</b> , RED <b>ER</b> , SAGE GREEN <b>E9</b> |

## Lazy Susan

Top Ceramic, Marble



| Version                   | Code     | Top Thickness | -- | Top   | Optional | Q.ty | boxes | Kg | M <sup>3</sup> |
|---------------------------|----------|---------------|----|-------|----------|------|-------|----|----------------|
| <b>Lazy Susan Ceramic</b> |          |               |    |       |          |      |       |    |                |
| Top Ø60 6 mm thk          |          |               |    |       |          |      |       |    |                |
|                           |          |               |    | GMA   |          |      |       |    |                |
| LS D. 60 H. 2.6           | A2220060 | 0.6           |    | 371 € |          | 1    | 1     | 7  | 0.01           |

### Lazy Susan Marble

Top Ø60 20 mm thk

|                 |          |   |  |       |  |   |   |    |      |
|-----------------|----------|---|--|-------|--|---|---|----|------|
|                 |          |   |  | GMM   |  |   |   |    |      |
| LS D. 60 H. 4.0 | A2220060 | 2 |  | 655 € |  | 1 | 1 | 16 | 0.02 |

#### Note:

--

#### Frame finishes

##### Metal

**MI** WHITE **BB**, BROWN **E6**, SAND **EC**, WHITE PEARL **EF**, GRAPHITE **EG**, BLACK **EN**

#### Top finishes

##### Veneer

|            |   |
|------------|---|
| <b>L11</b> | Stained BLACK <b>I04</b> , Stained WHITE <b>I05</b> , Stained NATURAL <b>I40</b> , Stained WHITENED <b>I60</b> , Stained DESERT <b>I61</b> , Stained LIGHT GREY <b>I62</b> , Stained DARK GREY <b>I63</b> |
| <b>L12</b> | NATURAL OAK <b>I22</b> , FLAMED WALNUT <b>I24</b>   |

##### Glass

|            |   |
|------------|---|
| <b>GVB</b> | EXTRA CLEAR GLOSSY CHERRY RED <b>J25</b> , EXTRA CLEAR GLOSSY BLUE SAPPHIRE <b>J26</b> , EXTRA CLEAR GLOSSY BLUE TURQUOISE <b>J27</b> |
| <b>GVC</b> | MATT GRAFITE ANTISCRATCH <b>J31</b> , MATT SAND ANTISCRATCH <b>J32</b>  |
| <b>GVD</b> | EXTRA CLEAR MATT WHITE ANTISCRATCH <b>J41</b>   |

##### Marble

|            |   |
|------------|---|
| <b>GMM</b> | BEIGE TRAVERTINO ROMANO <b>MB2</b> , WHITE CALACATTA VAGLI <b>MB4</b> , BLACK MARQUINIA <b>MN4</b> , GREEN TINOS <b>MVE</b> |
|------------|---|

##### HPL

|            |  |
|------------|--|
| <b>HH3</b> | ST WHITE/White Core <b>AB4</b> , ST SAND/Sand Core <b>ACR</b> , ST GRAPHITE GREY/ Grafite Core <b>AGD</b> , ST BLACK/Black Core <b>AN4</b> , ST TORTORA/Tortora Core <b>ATR</b> , ST RED NAMIB/Red Core <b>FAM</b> , ST YELLOW EVORA/Yellow Core <b>FGO</b> , ST RED BULGARO/Red Core <b>FRB</b> , ST GREEN KITAMI/Green Core <b>FVK</b> |
|------------|--|

##### Crystal Ceramic and Ceramic

|            |   |
|------------|---|
| <b>GMA</b> | MARBLE CALACATTA GLOSSY WHITE <b>K32</b> , BLACK GREEK MARBLE <b>K33</b> , MARBLE GLOSSY NOIR DESIR <b>K35</b> , MARBLE CALACATTA MATT WHITE <b>K42</b> , MARBLE MATT NOIR DESIR <b>K45</b> , MARBLE MATT GREEN TINOS <b>K46</b> , MARBLE STATUARIO WHITE MATT <b>K47</b> , MARBLE CALACAT BLACK Bush Hammered <b>K50</b> |
|------------|---|

## Table Plissé Elliptical

Frame in: metal



| Version               | Code     | Frame |  | Top     | Optional | Q.ty    | boxes | Kg    | M <sup>2</sup> |       |      |
|-----------------------|----------|-------|--|---------|----------|---------|-------|-------|----------------|-------|------|
| <b>Plissé Veneer</b>  |          |       |  |         |          |         |       |       |                |       |      |
| Top 19 mm. thk        |          |       |  |         |          |         |       |       |                |       |      |
|                       |          |       |  | L11     | L12      |         |       |       |                |       |      |
| 220x120 Elliptical    | T2220220 | M1    |  | 3.610 € | 4.050 €  | FM-M2   | 1     | 2     | 131.5          | 1.11  |      |
| 250x120 Elliptical    | T2220250 |       |  | 3.740 € | 4.210 €  |         | 1     | 2     | 144            | 1.15  |      |
| <b>Plissé Glass</b>   |          |       |  |         |          |         |       |       |                |       |      |
| Top 12 mm. thk        |          |       |  |         |          |         |       |       |                |       |      |
|                       |          |       |  | GVB     | GVC      | GVD     |       |       |                |       |      |
| 220x120 Elliptical    | T2220220 | M1    |  | 3.250 € | 3.310 €  | 3.390 € | FM-M2 | 1     | 2              | 167   | 1.11 |
| 250x120 Elliptical    | T2220250 | M1    |  | 3.400 € | 3.480 €  | 3.570 € |       | FM-M2 | 1              | 2     | 185  |
| <b>Plissé Ceramic</b> |          |       |  |         |          |         |       |       |                |       |      |
| Top 12 mm. thk        |          |       |  |         |          |         |       |       |                |       |      |
|                       |          |       |  | GKA     | GKB      | GMA     |       |       |                |       |      |
| 220x120 Elliptical    | T2220220 | M1    |  | 4.420 € | 4.646 €  | 5.080 € | FM-M2 | 1     | 2              | 161   | 1.11 |
| 250x120 Elliptical    | T2220250 |       |  | 4.570 € | 4.846 €  | 5.290 € |       | 1     | 2              | 177.6 | 1.15 |
| <b>Plissé Marble</b>  |          |       |  |         |          |         |       |       |                |       |      |
| Top 20 mm. thk        |          |       |  |         |          |         |       |       |                |       |      |
|                       |          |       |  | GMM     |          |         |       |       |                |       |      |
| 220x120 Elliptical    | T2220220 | M1    |  | 5.410 € |          | FM-M2   | 1     | 2     | 261            | 1.11  |      |
| 250x120 Elliptical    | T2220250 |       |  | 5.800 € |          |         | 1     | 2     | 292            | 1.15  |      |

**Frame finishes**

**Metal**

|           |   |
|-----------|---|
| <b>M1</b> | WHITE <b>BB</b> , BROWN <b>E6</b> , SAND <b>EC</b> , WHITE PEARL <b>EF</b> , GRAPHITE <b>EG</b> , BLACK <b>EN</b> |
|-----------|---|

**Top finishes**

**Veneer**

|            |  |
|------------|--|
| <b>L11</b> | Stained BLACK <b>I04</b> , Stained WHITE <b>I05</b> , Stained CHERRY RED <b>I09</b> , Stained DARK BROWN <b>I26</b> , Stained NATURAL <b>I40</b> , Stained NATURAL OAK <b>I52</b> , Stained WHITENED <b>I60</b> , Stained DESERT <b>I61</b> , Stained LIGHT GREY <b>I62</b> , Stained DARK GREY <b>I63</b> |
| <b>L12</b> | NATURAL OAK <b>I22</b> , FLAMED WALNUT <b>I24</b>  |

**Glass**

|            |   |
|------------|---|
| <b>GVB</b> | EXTRA CLEAR GLOSSY CHERRY RED <b>J25</b> , EXTRA CLEAR GLOSSY BLUE SAPPHIRE <b>J26</b> , EXTRA CLEAR GLOSSY BLUE TURQUOISE <b>J27</b> |
| <b>GVC</b> | MATT GRAFITE ANTISCRATCH <b>J31</b> , MATT SAND ANTISCRATCH <b>J32</b>  |
| <b>GVD</b> | EXTRA CLEAR MATT WHITE ANTISCRATCH <b>J41</b>   |

**Ceramic**

|            |  |
|------------|--|
| <b>GKA</b> | CHARCOAL SAVOIA <b>K11</b> , CEMENT SAVOIA <b>K12</b>  |
| <b>GKB</b> | WHITE CALCE <b>K24</b> , BLACK CALCE <b>K25</b> , TORTORA CALCE <b>K26</b> , PIASENTINA STONE TAUPE Materica <b>K55</b>  |
| <b>GMA</b> | MARBLE CALACATTA GLOSSY WHITE <b>K32</b> , BLACK GREEK MARBLE <b>K33</b> , MARBLE GLOSSY NOIR DESIR <b>K35</b> , MARBLE MATT NOIR DESIR <b>K45</b> , MARBLE MATT GREEN TINOS <b>K46</b> , MARBLE STATUARIO WHITE MATT <b>K47</b> , MARBLE CALACAT BLACK Bush Hammered <b>K50</b> |

**Marble**

|            |   |
|------------|---|
| <b>GMM</b> | BEIGE TRAVERTINO ROMANO <b>MB2</b> , WHITE CALACATTA VAGLI <b>MB4</b> , BLACK MARQUINIA <b>MN4</b> , GREEN TINOS <b>MVE</b> |
|------------|---|

**Optionals:**

|              |                      | Value   | Options/notes   |
|--------------|----------------------|---------|---|
| <b>FM-M2</b> | Indoor matt metal M2 | + 190 € | ASH GREY <b>ES</b> , BLUE SAPPHIRE <b>EE</b> , BLUE TURQUOISE <b>EH</b> , BRONZE <b>EZ</b> + TRANSP., BULGARO RED <b>FP</b> , CHERRY RED <b>EQ</b> , DARK GREEN <b>EL</b> , FACEPOWDER PINK <b>E8</b> , FANGO <b>E3</b> , GOLDEN YELLOW <b>EO</b> , LIGHT BLUE <b>EO</b> , LIGHT GREY <b>ET</b> , OCEAN BLUE <b>E1</b> , OCHER YELLOW <b>E7</b> , PAPAYA ORANGE <b>EA</b> , PASTEL YELLOW <b>E4</b> , PINE GREEN <b>EJ</b> , RED <b>ER</b> , SAGE GREEN <b>E9</b> |

## Table Plissé D.100-120

Frame in: metal



| Version | Code | Frame | -- | Top | Optional | Q.ty | boxes | Kg | M³ |
|---------|------|-------|----|-----|----------|------|-------|----|----|
|---------|------|-------|----|-----|----------|------|-------|----|----|

### Plissé Melamine

Top 18 mm. thk

|        |          |    |    | HL1     |       |   |   |    |      |
|--------|----------|----|----|---------|-------|---|---|----|------|
| D. 100 | T2220100 | M1 |    | 1.277 € | FM-M2 | 1 | 3 | 54 | 0.35 |
| D. 120 | T2220120 |    | -- | 1.325 € | FM-M2 | 1 | 3 | 59 | 0.39 |

### Plissé HPL

Top 10 mm. thk

|        |          |    |         | HH1     | HH2     | HH3     |       |    |      |    |      |
|--------|----------|----|---------|---------|---------|---------|-------|----|------|----|------|
| D. 100 | T2220100 | M1 | --      | 1.612 € | 1.765 € | 1.877 € | FM-M2 | 1  | 3    | 43 | 0.35 |
| D. 120 | T2220120 |    | 1.711 € | 1.860 € | 1.979 € | 1       | 3     | 48 | 0.39 |    |      |

### Plissé Veneer

Top 20 mm. thk

|        |          |    |         | LI1     | LI2     |       |    |      |    |      |
|--------|----------|----|---------|---------|---------|-------|----|------|----|------|
| D. 100 | T2220100 | M1 | --      | 1.658 € | 1.743 € | FM-M2 | 1  | 3    | 54 | 0.35 |
| D. 120 | T2220120 |    | 1.711 € | 1.796 € | 1       | 3     | 59 | 0.39 |    |      |

### Plissé Glass

Top 10 mm. thk

|        |          |    |         | GVB     | GVC     | GVD     |       |    |      |    |      |
|--------|----------|----|---------|---------|---------|---------|-------|----|------|----|------|
| D. 100 | T2220100 | M1 | --      | 1.646 € | 1.829 € | 1.925 € | FM-M2 | 1  | 3    | 66 | 0.35 |
| D. 120 | T2220120 |    | 1.773 € | 1.946 € | 2.064 € | 1       | 3     | 74 | 0.39 |    |      |

### Plissé Ceramic

Top 13-16 mm. thk

|        |          |    |         | GKB     | GMA     |       |    |      |    |      |
|--------|----------|----|---------|---------|---------|-------|----|------|----|------|
| D. 100 | T2220100 | M1 | --      | 1.990 € | 2.172 € | FM-M2 | 1  | 3    | 76 | 0.35 |
| D. 120 | T2220120 |    | 2.290 € | 2.396 € | 1       | 3     | 89 | 0.39 |    |      |

### Plissé Marble

Top 20 mm. thk

|        |          |    |         | GMM     |       |     |      |     |      |  |
|--------|----------|----|---------|---------|-------|-----|------|-----|------|--|
| D. 100 | T2220100 | M1 | --      | 2.707 € | FM-M2 | 1   | 3    | 100 | 0.35 |  |
| D. 120 | T2220120 |    | 3.060 € | 1       | 3     | 113 | 0.39 |     |      |  |

### Note:

Top Ceramic K26 D.100 reduced diameter - D.120 NOT available - Top Ceramic K55,K90,K91 D.120 reduced diameter

**Optionals:**

|              |                      | Value  | Options/notes   |
|--------------|----------------------|--------|---|
| <b>FM-M2</b> | Indoor matt metal M2 | + 82 € | ASH GREY <b>ES</b> , BLUE SAPPHIRE <b>EE</b> , BLUE TURQUOISE <b>EH</b> , BRONZE <b>EZ</b> + TRANSP., BULGARO RED <b>FP</b> , CHERRY RED <b>EQ</b> , DARK GREEN <b>EL</b> , FACEPOWDER PINK <b>E8</b> , FANGO <b>E3</b> , GOLDEN YELLOW <b>EO</b> , LIGHT BLUE <b>EO</b> , LIGHT GREY <b>ET</b> , OCEAN BLUE <b>EI</b> , OCHER YELLOW <b>E7</b> , PAPAYA ORANGE <b>EA</b> , PASTEL YELLOW <b>E4</b> , PINE GREEN <b>EJ</b> , RED <b>ER</b> , SAGE GREEN <b>E9</b> |

**Frame finishes**

**Metal**

|           |   |
|-----------|---|
| <b>MI</b> | WHITE <b>BB</b> , BROWN <b>E6</b> , SAND <b>EC</b> , WHITE PEARL <b>EF</b> , GRAPHITE <b>EG</b> , BLACK <b>EN</b> |
|-----------|---|

**Top finishes**

**Veneer**

|            |   |
|------------|---|
| <b>LII</b> | Stained BLACK <b>I04</b> , Stained WHITE <b>I05</b> , Stained NATURAL <b>I40</b> , Stained WHITENED <b>I60</b> , Stained DESERT <b>I61</b> , Stained LIGHT GREY <b>I62</b> , Stained DARK GREY <b>I63</b> |
| <b>LI2</b> | NATURAL OAK <b>I22</b> , FLAMED WALNUT <b>I24</b>   |

**Marble**

|            |   |
|------------|---|
| <b>GMM</b> | BEIGE TRAVERTINO ROMANO <b>MB2</b> , WHITE CALACATTA VAGLI <b>MB4</b> , BLACK MARQUINIA <b>MN4</b> , GREEN TINOS <b>MVE</b> |
|------------|---|

**Melamine**

|            |  |
|------------|--|
| <b>HLI</b> | WHITE <b>M01</b> , GRAFITE <b>M02</b> , BLACK <b>M04</b> , SAND <b>M07</b> |
|------------|--|

**Crystal Ceramic and Ceramic**

|            |   |
|------------|---|
| <b>GKB</b> | WHITE CALCE <b>K24</b> , BLACK CALCE <b>K25</b> , TORTORA CALCE <b>K26</b> , PIASENTINA STONE TAUPE Materica <b>K55</b> , TERRACOTTA Matt <b>K90</b> , MATT GREEN <b>K91</b>  |
| <b>GMA</b> | MARBLE CALACATTA GLOSSY WHITE <b>K32</b> , BLACK GREEK MARBLE <b>K33</b> , MARBLE GLOSSY NOIR DESIR <b>K35</b> , MARBLE CALACATTA MATT WHITE <b>K42</b> , MARBLE MATT NOIR DESIR <b>K45</b> , MARBLE MATT GREEN TINOS <b>K46</b> , MARBLE STATUARIO WHITE MATT <b>K47</b> , MARBLE CALACAT BLACK Bush Hammered <b>K50</b> |

**Glass**

|            |   |
|------------|---|
| <b>GVB</b> | EXTRA CLEAR GLOSSY CHERRY RED <b>J25</b> , EXTRA CLEAR GLOSSY BLUE SAPPHIRE <b>J26</b> , EXTRA CLEAR GLOSSY BLUE TURQUOISE <b>J27</b> |
| <b>GVC</b> | MATT GRAFITE ANTISCRATCH <b>J31</b> , MATT SAND ANTISCRATCH <b>J32</b>  |
| <b>GVD</b> | EXTRA CLEAR MATT WHITE ANTISCRATCH <b>J41</b>   |

**HPL**

|            |  |
|------------|--|
| <b>HHI</b> | WHITE/Black Core <b>HB4</b> , BLACK/Black Core <b>HN4</b>  |
| <b>HH2</b> | CEMENT/Black Core <b>HC6</b> , CORTEN/Brown Core <b>HC7</b> , DARK GREY/Black Core <b>HGW</b>  |
| <b>HH3</b> | ST WHITE/White Core <b>AB4</b> , ST SAND/Sand Core <b>ACR</b> , ST GRAPHITE GREY/ Grafite Core <b>AGD</b> , ST BLACK/Black Core <b>AN4</b> , ST TORTORA/Tortora Core <b>ATR</b> , ST RED NAMIB/Red Core <b>FAM</b> , ST YELLOW EVORA/Yellow Core <b>FGO</b> , ST RED BULGARO/Red Core <b>FRB</b> , ST GREEN KITAMI/Green Core <b>FVK</b> |

## Table Plissé INOX D.100-120-150

Frame in: INOX



| Version | Code | Frame | -- | Top | Optional | Q.ty | boxes | Kg | M³ |
|---------|------|-------|----|-----|----------|------|-------|----|----|
|---------|------|-------|----|-----|----------|------|-------|----|----|

### Plissé HPL

Top 10 mm. thk

|             |          |    |    | HH1     | HH2     | HH3     |       |   |   |    |      |
|-------------|----------|----|----|---------|---------|---------|-------|---|---|----|------|
| D. 100 Inox | T2221100 | M1 | -- | 1.775 € | 1.928 € | 2.040 € | FM-M2 | 1 | 3 | 43 | 0.35 |
| D. 120 Inox | T2221120 |    |    | 1.874 € | 2.024 € | 2.142 € |       | 1 | 3 | 48 | 0.39 |

### Plissé Glass

Top 10 mm. thk

|             |          |    |    | GVB     | GVC     | GVD     |       |   |   |    |      |
|-------------|----------|----|----|---------|---------|---------|-------|---|---|----|------|
| D. 100 Inox | T2221100 | M1 | -- | 1.809 € | 1.992 € | 2.088 € | FM-M2 | 1 | 3 | 66 | 0.35 |
| D. 120 Inox | T2221120 |    |    | 1.936 € | 2.109 € | 2.228 € |       | 1 | 3 | 74 | 0.39 |

### Plissé Ceramic

Top 13-16 mm. thk

|             |          |    |    | GMA     |  |       |   |   |    |      |
|-------------|----------|----|----|---------|--|-------|---|---|----|------|
| D. 100 Inox | T2221100 | M1 | -- | 2.335 € |  | FM-M2 | 1 | 3 | 76 | 0.35 |
| D. 120 Inox | T2221120 |    |    | 2.559 € |  |       | 1 | 3 | 89 | 0.39 |

### Plissé Marble

Top 20 mm. thk

|             |          |    |    | GMM     |  |       |   |   |     |      |
|-------------|----------|----|----|---------|--|-------|---|---|-----|------|
| D. 100 Inox | T2221100 | M1 | -- | 2.870 € |  | FM-M2 | 1 | 3 | 100 | 0.35 |
| D. 120 Inox | T2221120 |    |    | 3.223 € |  |       | 1 | 3 | 113 | 0.39 |

**Note:**

| Optionals:   |                      |        |   |
|--------------|----------------------|--------|---|
|              |                      | Value  | Options/notes   |
| <b>FM-M2</b> | Indoor matt metal M2 | + 82 € | ASH GREY <b>ES</b> , BLUE SAPPHIRE <b>EE</b> , BLUE TURQUOISE <b>EH</b> , BRONZE <b>EZ</b> + TRANSP., BULGARO RED <b>FP</b> , CHERRY RED <b>EQ</b> , DARK GREEN <b>EL</b> , FACEPOWDER PINK <b>EB</b> , FANGO <b>E3</b> , GOLDEN YELLOW <b>EO</b> , LIGHT BLUE <b>EO</b> , LIGHT GREY <b>ET</b> , OCEAN BLUE <b>EI</b> , OCHER YELLOW <b>E7</b> , PAPAYA ORANGE <b>EA</b> , PASTEL YELLOW <b>E4</b> , PINE GREEN <b>EJ</b> , RED <b>ER</b> , SAGE GREEN <b>E9</b> |

**Frame finishes**

| Metal     |   |
|-----------|---|
| <b>MI</b> | WHITE <b>BB</b> , BROWN <b>E6</b> , SAND <b>EC</b> , WHITE PEARL <b>EF</b> , GRAPHITE <b>EG</b> , BLACK <b>EN</b> |

**Top finishes**

| Crystal Ceramic and Ceramic |   |
|-----------------------------|---|
| <b>GMA</b>                  | MARBLE CALACATTA GLOSSY WHITE <b>K32</b> , BLACK GREEK MARBLE <b>K33</b> , MARBLE GLOSSY NOIR DESIR <b>K35</b> , MARBLE CALACATTA MATT WHITE <b>K42</b> , MARBLE MATT NOIR DESIR <b>K45</b> , MARBLE MATT GREEN TINOS <b>K46</b> , MARBLE STATUARIO WHITE MATT <b>K47</b> , MARBLE CALACAT BLACK Bush Hammered <b>K50</b> |

| Marble     |   |
|------------|---|
| <b>GMM</b> | BEIGE TRAVERTINO ROMANO <b>MB2</b> , WHITE CALACATTA VAGLI <b>MB4</b> , BLACK MARQUINIA <b>MN4</b> , GREEN TINOS <b>MVE</b> |

| Glass      |   |
|------------|---|
| <b>GVB</b> | EXTRA CLEAR GLOSSY CHERRY RED <b>J25</b> , EXTRA CLEAR GLOSSY BLUE SAPPHIRE <b>J26</b> , EXTRA CLEAR GLOSSY BLUE TURQUOISE <b>J27</b> |
| <b>GVC</b> | MATT GRAFITE ANTISCRATCH <b>J31</b> , MATT SAND ANTISCRATCH <b>J32</b>  |
| <b>GVD</b> | EXTRA CLEAR MATT WHITE ANTISCRATCH <b>J41</b>   |

| HPL        |  |
|------------|--|
| <b>HH1</b> | WHITE/Black Core <b>HB4</b> , BLACK/Black Core <b>HN4</b>  |
| <b>HH2</b> | CEMENT/Black Core <b>HC6</b> , CORTEN/Brown Core <b>HC7</b> , DARK GREY/Black Core <b>HGW</b>  |
| <b>HH3</b> | ST WHITE/White Core <b>AB4</b> , ST SAND/Sand Core <b>ACR</b> , ST GRAPHITE GREY/ Grafite Core <b>AGD</b> , ST BLACK/Black Core <b>AN4</b> , ST TORTORA/Tortora Core <b>ATR</b> , ST RED NAMIB/Red Core <b>FAM</b> , ST YELLOW EVORA/Yellow Core <b>FGO</b> , ST RED BULGARO/Red Core <b>FRB</b> , ST GREEN KITAMI/Green Core <b>FVK</b> |

| Version | Code | Frame | -- | Top | Optional |  |  |  |  |
|---------|------|-------|----|-----|----------|--|--|--|--|
|---------|------|-------|----|-----|----------|--|--|--|--|

**Plissé Glass**

Top 10 mm. thk

|             |          |    |    | GVB     | GVC     | GVD     |       |   |   |     |     |
|-------------|----------|----|----|---------|---------|---------|-------|---|---|-----|-----|
| D. 150 Inox | T2221150 | M1 | -- | 3.403 € | 3.437 € | 3.499 € | FM-M2 | 1 | 3 | 119 | 0.8 |

**Plissé Ceramic**

Top 13-16 mm. thk

|             |          |    |    | GMA     |  |  |       |   |   |     |     |
|-------------|----------|----|----|---------|--|--|-------|---|---|-----|-----|
| D. 150 Inox | T2221150 | M1 | -- | 3.589 € |  |  | FM-M2 | 1 | 3 | 132 | 0.8 |

**Plissé Marble**

Top 20 mm. thk

|             |          |    |  | GMM     |  |  |       |   |   |     |     |
|-------------|----------|----|--|---------|--|--|-------|---|---|-----|-----|
| D. 150 Inox | T2221150 | M1 |  | 5.234 € |  |  | FM-M2 | 1 | 3 | 159 | 0.8 |

**Note:**

**Optionals:**

|              |                      | Value   | Options/notes   |
|--------------|----------------------|---------|---|
| <b>FM-M2</b> | Indoor matt metal M2 | + 122 € | ASH GREY <b>ES</b> , BLUE SAPPHIRE <b>EE</b> , BLUE TURQUOISE <b>EH</b> , BRONZE <b>EZ</b> + TRANSP., BULGARO RED <b>FP</b> , CHERRY RED <b>EQ</b> , DARK GREEN <b>EL</b> , FACEPOWDER PINK <b>E8</b> , FANGO <b>E3</b> , GOLDEN YELLOW <b>EO</b> , LIGHT BLUE <b>EO</b> , LIGHT GREY <b>ET</b> , OCEAN BLUE <b>EI</b> , OCHER YELLOW <b>E7</b> , PAPAYA ORANGE <b>EA</b> , PASTEL YELLOW <b>E4</b> , PINE GREEN <b>EJ</b> , RED <b>ER</b> , SAGE GREEN <b>E9</b> |

**Frame finishes**

**Metal**

|           |   |
|-----------|---|
| <b>MI</b> | WHITE <b>BB</b> , BROWN <b>E6</b> , SAND <b>EC</b> , WHITE PEARL <b>EF</b> , GRAPHITE <b>EG</b> , BLACK <b>EN</b> |
|-----------|---|

**Top finishes**

**Crystal Ceramic and Ceramic**

|            |  |
|------------|--|
| <b>GMA</b> | MARBLE CALACATTA GLOSSY WHITE <b>K32</b> , BLACK GREEK MARBLE <b>K33</b> , MARBLE GLOSSY NOIR DESIR <b>K35</b> , MARBLE CALACATTA MATT WHITE <b>K42</b> , MARBLE MATT NOIR DESIR <b>K45</b> , MARBLE STATUARIO WHITE MATT <b>K47</b> , MARBLE CALACAT BLACK Bush Hammered <b>K50</b> |
|------------|--|

**Marble**

|            |   |
|------------|---|
| <b>GMM</b> | BEIGE TRAVERTINO ROMANO <b>MB2</b> , WHITE CALACATTA VAGLI <b>MB4</b> , BLACK MARQUINIA <b>MN4</b> , GREEN TINOS <b>MVE</b> |
|------------|---|

**Glass**

|            |   |
|------------|---|
| <b>GVB</b> | EXTRA CLEAR GLOSSY CHERRY RED <b>J25</b> , EXTRA CLEAR GLOSSY BLUE SAPPHIRE <b>J26</b> , EXTRA CLEAR GLOSSY BLUE TURQUOISE <b>J27</b> |
| <b>GVC</b> | MATT GRAFITE ANTISCRATCH <b>J31</b> , MATT SAND ANTISCRATCH <b>J32</b>  |
| <b>GVD</b> | EXTRA CLEAR MATT WHITE ANTISCRATCH <b>J41</b>   |

**D. 150**

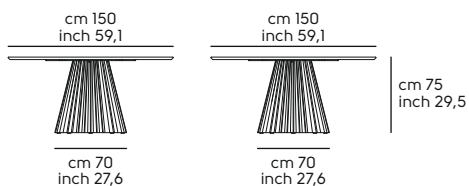

**D. 180**

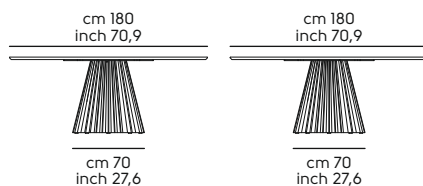

**LS D. 60**

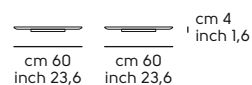

**D. 100**

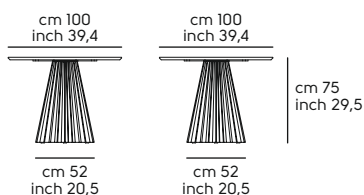

**D. 120**

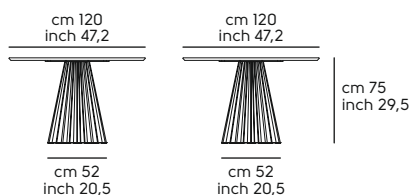

**Elliptical 220x120**

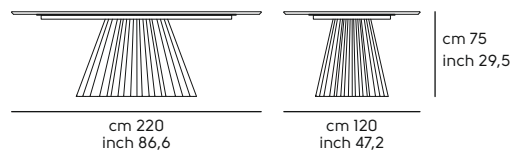

**Elliptical 250x120**

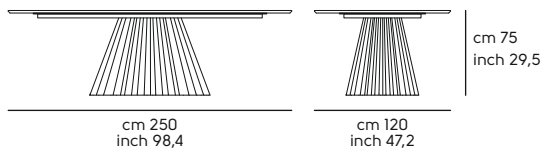

# Sesamo design Officina delle Idee

## Table Sesamo

Frame in: metal



T  
A  
B  
L  
E  
S

| Version | Code | Frame | Frame | Top and extensions | Optional | Q.ty | boxes | Kg | M <sup>3</sup> |
|---------|------|-------|-------|--------------------|----------|------|-------|----|----------------|
|---------|------|-------|-------|--------------------|----------|------|-------|----|----------------|

### Sesamo Veneer

Top and extensions 20 mm thk

|                        |          |    |    | LI1     | LI2     |       |   |   |     |      |
|------------------------|----------|----|----|---------|---------|-------|---|---|-----|------|
| D.120/180x120          | T2410D12 |    |    | 2.880 € | 2.960 € |       | 1 | 2 | 146 | 0.69 |
| 120/180x120 Barrel     | T2410B12 |    |    | 2.854 € | 2.934 € |       | 1 | 2 | 149 | 0.69 |
| 220/280x120 Barrel     | T2410B22 | MI | MI | 4.520 € | 4.680 € | FM-M2 | 1 | 2 | 164 | 0.91 |
| 220/280x120 Elliptical | T2410E22 |    |    | 4.650 € | 4.810 € |       | 1 | 2 | 158 | 0.91 |

### Sesamo Glass

Top and extensions 16+4 mm thk

|                        |          |    |    | GVB     | GVC     | GVD     |       |   |   |     |      |
|------------------------|----------|----|----|---------|---------|---------|-------|---|---|-----|------|
| D.120/180x120          | T2410D12 |    |    | 3.190 € | 3.320 € | 3.430 € |       | 1 | 2 | 160 | 0.69 |
| 120/180x120 Barrel     | T2410B12 |    |    | 3.160 € | 3.290 € | 3.400 € |       | 1 | 2 | 166 | 0.69 |
| 220/280x120 Barrel     | T2410B22 | MI | MI | 4.310 € | 4.490 € | 4.650 € | FM-M2 | 1 | 2 | 207 | 0.91 |
| 220/280x120 Elliptical | T2410E22 |    |    | 4.390 € | 4.570 € | 4.730 € |       | 1 | 2 | 194 | 0.91 |

### Sesamo Ceramic

Top and extensions 16+6 mm thk

|                        |          |    |    | GKA     | GKB     | GMA     |       |   |   |     |      |
|------------------------|----------|----|----|---------|---------|---------|-------|---|---|-----|------|
| D.120/180x120          | T2410D12 |    |    | 3.963 € | 4.043 € | 4.123 € |       | 1 | 2 | 168 | 0.69 |
| 120/180x120 Barrel     | T2410B12 |    |    | 3.934 € | 4.014 € | 4.094 € |       | 1 | 2 | 177 | 0.69 |
| 220/280x120 Barrel     | T2410B22 | MI | MI | 4.760 € | 4.920 € | 4.980 € | FM-M2 | 1 | 2 | 231 | 0.91 |
| 220/280x120 Elliptical | T2410E22 |    |    | 4.830 € | 4.990 € | 5.050 € |       | 1 | 2 | 213 | 0.91 |

### Note:

Ceramic K26 Calce Tortora NOT available for 220/280x120 Barrel e Elliptical

### Optionals:

|              |                      | Value   | Options/notes  |
|--------------|----------------------|---------|--|
| <b>FM-M2</b> | Indoor matt metal M2 | + 150 € | ASH GREY <b>ES</b> , BLUE SAPPHIRE <b>EE</b> , BLUE TURQUOISE <b>EH</b> , BRONZE <b>E2</b> , BULGARO RED <b>FP</b> , CHERRY RED <b>EQ</b> , DARK GREEN <b>EL</b> , FACEPOWDER PINK <b>E8</b> , FANGO <b>E3</b> , GOLDEN YELLOW <b>EO</b> , LIGHT BLUE <b>EO</b> , LIGHT GREY <b>ET</b> , OCEAN BLUE <b>EI</b> , OCHER YELLOW <b>E7</b> , PAPAYA ORANGE <b>EA</b> , PASTEL YELLOW <b>E4</b> , PINE GREEN <b>EJ</b> , RED <b>ER</b> , SAGE GREEN <b>E9</b> |

## Table Sesamo

Frame in: wood

| Version                      | Code     | Frame | Frame | Top and extensions | Optional | Q.ty  | boxes | Kg | M <sup>2</sup> |      |
|------------------------------|----------|-------|-------|--------------------|----------|-------|-------|----|----------------|------|
| <b>Sesamo Veneer</b>         |          |       |       |                    |          |       |       |    |                |      |
| Top and extensions 20 mm thk |          |       |       |                    |          |       |       |    |                |      |
|                              |          |       |       | L11                | L12      |       |       |    |                |      |
| D.120/180x120                | T2411D12 |       |       | 3.370 €            | 3.450 €  |       | 1     | 2  | 146            | 0.69 |
| 120/180x120 Barrel           | T2411B12 | L11   | M1    | 3.344 €            | 3.424 €  | FL-12 | 1     | 2  | 149            | 0.69 |
| 220/280x120 Barrel           | T2411B22 |       |       | 4.940 €            | 5.100 €  |       | 1     | 2  | 164            | 0.91 |
| 220/280x120 Elliptical       | T2411E22 |       |       | 5.070 €            | 5.230 €  |       | 1     | 2  | 158            | 0.91 |

### Sesamo Glass

Top and extensions 16+4 mm thk

|                        |          |     |    |         |         |         |       |   |   |     |      |
|------------------------|----------|-----|----|---------|---------|---------|-------|---|---|-----|------|
|                        |          |     |    | GVB     | GVC     | GVD     |       |   |   |     |      |
| D.120/180x120          | T2411D12 |     |    | 3.580 € | 3.710 € | 3.820 € |       | 1 | 2 | 160 | 0.69 |
| 120/180x120 Barrel     | T2411B12 | L11 | M1 | 3.550 € | 3.680 € | 3.790 € | FL-12 | 1 | 2 | 166 | 0.69 |
| 220/280x120 Barrel     | T2411B22 |     |    | 4.700 € | 4.880 € | 5.040 € |       | 1 | 2 | 207 | 0.91 |
| 220/280x120 Elliptical | T2411E22 |     |    | 4.780 € | 4.960 € | 5.120 € |       | 1 | 2 | 194 | 0.91 |

### Sesamo Ceramic

Top and extensions 16+6 mm thk

|                        |          |     |    |         |         |         |       |   |   |     |      |
|------------------------|----------|-----|----|---------|---------|---------|-------|---|---|-----|------|
|                        |          |     |    | GKA     | GKB     | GMA     |       |   |   |     |      |
| D.120/180x120          | T2411D12 |     |    | 4.453 € | 4.533 € | 4.613 € |       | 1 | 2 | 168 | 0.69 |
| 120/180x120 Barrel     | T2411B12 | L11 | M1 | 4.424 € | 4.504 € | 4.584 € | FL-12 | 1 | 2 | 177 | 0.69 |
| 220/280x120 Barrel     | T2411B22 |     |    | 5.180 € | 5.340 € | 5.400 € |       | 1 | 2 | 231 | 0.91 |
| 220/280x120 Elliptical | T2411E22 |     |    | 5.250 € | 5.410 € | 5.470 € |       | 1 | 2 | 213 | 0.91 |

#### Note:

Ceramic K26 Calce Tortora NOT available for 220/280x120 Barrel e Elliptical

| Optionals:   |                          | Value   | Options/notes   |
|--------------|--------------------------|---------|---|
| <b>FL-I2</b> | Veneered wood finish LI2 | + 220 € | Veneered wood FLAMED WALNUT <b>I24</b> , Veneered wood NATURAL OAK <b>I22</b> |

### Frame finishes

| Metal     |   |
|-----------|---|
| <b>MI</b> | WHITE <b>BB</b> , BROWN <b>E6</b> , SAND <b>EC</b> , WHITE PEARL <b>EF</b> , GRAPHITE <b>EG</b> , BLACK <b>EN</b> |

### Frame finishes

| Metal     |   |
|-----------|---|
| <b>MI</b> | WHITE <b>BB</b> , BROWN <b>E6</b> , SAND <b>EC</b> , WHITE PEARL <b>EF</b> , GRAPHITE <b>EG</b> , BLACK <b>EN</b> |

### Frame finishes

| Veneer     |  |
|------------|--|
| <b>LII</b> | Veneered wood painted BLACK <b>I04</b> , Veneered wood painted WHITE <b>I05</b> , Veneered wood painted CHERRY RED <b>I09</b> , Veneered wood painted DARK BROWN <b>I26</b> , Veneered wood painted NATURAL <b>I40</b> , Veneered wood painted NATURAL OAK <b>I52</b> , Veneered wood painted WHITENED <b>I60</b> , Veneered wood painted DESERT <b>I61</b> , Veneered wood painted LIGHT GREY <b>I62</b> , Veneered wood painted DARK GREY <b>I63</b> |

### Top and extensions finishes

| Veneer     |  |
|------------|--|
| <b>LII</b> | Stained BLACK <b>I04</b> , Stained WHITE <b>I05</b> , Stained CHERRY RED <b>I09</b> , Stained DARK BROWN <b>I26</b> , Stained NATURAL <b>I40</b> , Stained NATURAL OAK <b>I52</b> , Stained WHITENED <b>I60</b> , Stained DESERT <b>I61</b> , Stained LIGHT GREY <b>I62</b> , Stained DARK GREY <b>I63</b> |
| <b>LI2</b> | NATURAL OAK <b>I22</b> , FLAMED WALNUT <b>I24</b>  |

| Ceramic    |   |
|------------|---|
| <b>GKA</b> | CHARCOAL SAVOIA <b>K11</b> , CEMENT SAVOIA <b>K12</b>   |
| <b>GKB</b> | WHITE CALCE <b>K24</b> , BLACK CALCE <b>K25</b> , TORTORA CALCE <b>K26</b> , PIASENTINA STONE TAUPE Materica <b>K55</b> , TERRACOTTA Matt <b>K90</b> , MATT GREEN <b>K91</b>  |
| <b>GMA</b> | MARBLE CALACATTA GLOSSY WHITE <b>K32</b> , BLACK GREEK MARBLE <b>K33</b> , MARBLE GLOSSY NOIR DESIR <b>K35</b> , MARBLE CALACATTA MATT WHITE <b>K42</b> , MARBLE MATT NOIR DESIR <b>K45</b> , MARBLE MATT GREEN TINOS <b>K46</b> , MARBLE STATUARIO WHITE MATT <b>K47</b> , MARBLE CALACAT BLACK Bush Hammered <b>K50</b> |

| Glass      |  |
|------------|--|
| <b>GVB</b> | GLOSSY SAND <b>J11</b> , EXTRA CLEAR GLOSSY WHITE <b>J21</b> , EXTRA CLEAR GLOSSY CHERRY RED <b>J25</b> , EXTRA CLEAR GLOSSY BLUE SAPPHIRE <b>J26</b> , EXTRA CLEAR GLOSSY BLUE TURQUOISE <b>J27</b> |
| <b>GVC</b> | MATT GRAFITE ANTISCRATCH <b>J31</b> , MATT SAND ANTISCRATCH <b>J32</b>   |
| <b>GVD</b> | EXTRA CLEAR MATT WHITE ANTISCRATCH <b>J41</b>  |

#### D.120/180x120

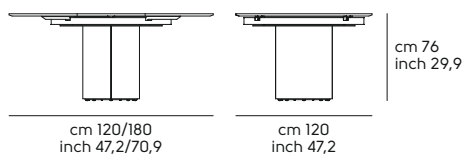

#### 120/180x120 - Barrel

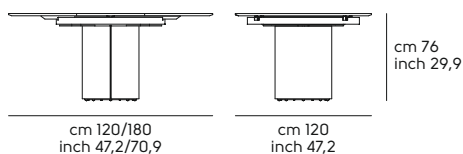

#### 220/280x120 - Barrel

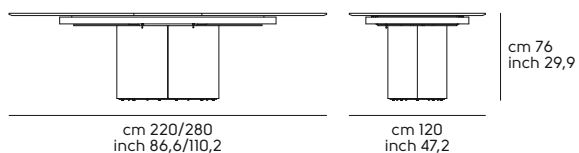

#### 220/280x120 - Elliptical

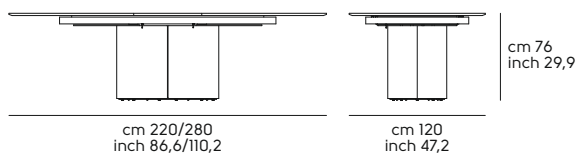

# Spike design Giulio Iacchetti

## Table Spike

Frame in: metal



| Version | Code | Frame | -- | Top | Optional | Q.ty | boxes | Kg | M <sup>3</sup> |
|---------|------|-------|----|-----|----------|------|-------|----|----------------|
|---------|------|-------|----|-----|----------|------|-------|----|----------------|

### Spike Glass

Top 12 mm. thk

|         |          |    |  | GVA     | GVE     |       |   |   |      |
|---------|----------|----|--|---------|---------|-------|---|---|------|
| D. 140  | T2240D14 |    |  | 3.997 € | 4.139 € |       |   |   |      |
| 200x100 | T2240200 | M1 |  | 4.139 € | 4.248 € | FM-M2 | 1 | 2 | 165  |
| 240x100 | T2240240 |    |  | 4.441 € | 4.701 € | FM-M4 | 1 | 2 | 204  |
|         |          |    |  |         |         |       |   |   | 231  |
|         |          |    |  |         |         |       |   |   | 0.95 |
|         |          |    |  |         |         |       |   |   | 0.98 |
|         |          |    |  |         |         |       |   |   | 1.12 |

### Frame finishes

#### Metal

|           |   |
|-----------|---|
| <b>M1</b> | WHITE <b>BB</b> , BROWN <b>E6</b> , SAND <b>EC</b> , GRAPHITE <b>EG</b> , BLACK <b>EN</b> |
|-----------|---|

### Top finishes

#### Glossy Glass

|            |                         |
|------------|-------------------------|
| <b>GVA</b> | TRANSPARENT <b>J02</b>  |
| <b>GVE</b> | GLOSSY FUME' <b>J05</b> |

### Optionals:

|              |                        | Value   | Options/notes  |
|--------------|------------------------|---------|--|
| <b>FM-M2</b> | Indoor matt metal M2   | + 197 € | ASH GREY <b>ES</b> , BLUE SAPPHIRE <b>EE</b> , BLUE TURQUOISE <b>EH</b> , BRONZE <b>E2</b> , BULGARO RED <b>FP</b> , CHERRY RED <b>EQ</b> , DARK GREEN <b>EL</b> , FACEPOWDER PINK <b>E8</b> , FANGO <b>E3</b> , GOLDEN YELLOW <b>EO</b> , LIGHT BLUE <b>EO</b> , LIGHT GREY <b>ET</b> , OCEAN BLUE <b>EI</b> , OCHER YELLOW <b>E7</b> , PAPAYA ORANGE <b>EA</b> , PASTEL YELLOW <b>E4</b> , PINE GREEN <b>EJ</b> , RED <b>ER</b> , SAGE GREEN <b>E9</b> |
| <b>FM-M4</b> | Indoor glossy Metal M4 | + 274 € | MATT BLACK NICKEL <b>DY</b> , MATT GOLDEN BRONZE <b>DC</b>   |

### D. 140

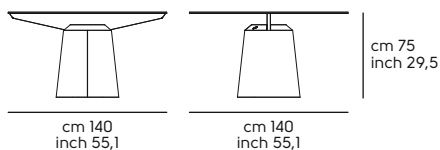

### 200x100

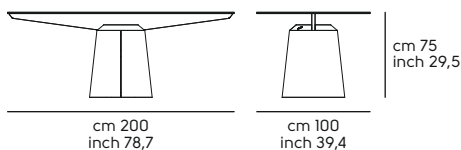

### 240x100

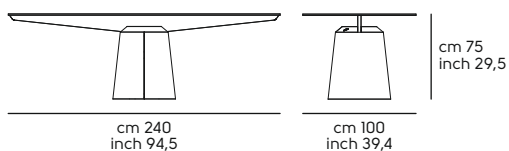

# Woody design Officina delle Idee

## Table Woody

Frame in: metal. Legs: covered with solid ash



### Woody Veneer

Top and extensions 19 mm thk

|                     |          |     |    | L11     | L12     |       |   |   |      |      |
|---------------------|----------|-----|----|---------|---------|-------|---|---|------|------|
| 120x 80             | T2150121 |     |    | 1.570 € | 1.760 € |       | 1 | 3 | 47   | 0.23 |
| 140x 90             | T2150139 |     |    | 1.737 € | 1.950 € |       | 1 | 3 | 53   | 0.27 |
| 160x 90             | T2150161 |     |    | 1.926 € | 2.300 € |       | 1 | 3 | 56   | 0.29 |
| 180x 90             | T2150179 |     |    | 2.230 € | 2.560 € |       | 1 | 3 | 60.5 | 0.34 |
| 180x100             | T2150181 |     |    | 2.330 € | 2.660 € |       | 1 | 3 | 62   | 0.34 |
| 120/170x 80         | T2151121 |     |    | 2.103 € | 2.160 € |       | 1 | 4 | 52   | 0.27 |
| 140/200x 90         | T2151139 |     |    | 2.160 € | 2.560 € |       | 1 | 4 | 60.7 | 0.28 |
| 140/190/240x 90     | T2151142 | LFI | MI | 2.732 € | 2.960 € | FM-M2 | 1 | 5 | 65.3 | 0.35 |
| 140/190/240/290x 90 | T2151143 |     |    | 2.740 € | 3.160 € |       | 1 | 5 | 76.7 | 0.35 |
| 160/220x 90         | T2151158 |     |    | 2.350 € | 2.760 € |       | 1 | 4 | 62.7 | 0.31 |
| 160/210/260x 90     | T2151159 |     |    | 2.640 € | 3.060 € |       | 1 | 5 | 70.7 | 0.33 |
| 160/210/260/310x 90 | T2151161 |     |    | 2.840 € | 3.360 € |       | 1 | 6 | 83.7 | 0.45 |
| 180/240x 90         | T2151171 |     |    | 2.760 € | 3.220 € |       | 1 | 4 | 68.5 | 0.38 |
| 180/230/280x 90     | T2151172 |     |    | 3.150 € | 3.620 € |       | 1 | 5 | 76.5 | 0.40 |
| 180/240x100         | T2151179 |     |    | 2.890 € | 3.350 € |       | 1 | 4 | 73   | 0.40 |
| 180/230/280x100     | T2151181 |     |    | 3.280 € | 3.750 € |       | 1 | 5 | 81.6 | 0.46 |

### Woody HPL

Top and extensions 10 mm thk

|                     |          |     |    | HH1     | HH2     | HH3     |       |   |   |      |      |
|---------------------|----------|-----|----|---------|---------|---------|-------|---|---|------|------|
| 120x 80             | T2150121 |     |    | 1.440 € | 1.510 € | 1.800 € |       | 1 | 3 | 47   | 0.23 |
| 140x 90             | T2150139 |     |    | 1.500 € | 1.580 € | 1.920 € |       | 1 | 3 | 53   | 0.27 |
| 160x 90             | T2150161 |     |    | 1.850 € | 2.000 € | 2.200 € |       | 1 | 3 | 56   | 0.29 |
| 180x 90             | T2150179 |     |    | 2.030 € | 2.180 € | 2.360 € |       | 1 | 3 | 60.5 | 0.34 |
| 180x100             | T2150181 |     |    | 2.130 € | 2.280 € | 2.460 € |       | 1 | 3 | 62   | 0.34 |
| 120/170x 80         | T2151121 |     |    | 1.790 € | 1.820 € | 2.020 € |       | 1 | 4 | 52   | 0.27 |
| 140/200x 90         | T2151139 |     |    | 2.030 € | 2.060 € | 2.280 € |       | 1 | 4 | 60.7 | 0.28 |
| 140/190/240x 90     | T2151142 | LFI | MI | 2.300 € | 2.340 € | 2.650 € | FM-M2 | 1 | 5 | 65.3 | 0.35 |
| 140/190/240/290x 90 | T2151143 |     |    | 2.480 € | 2.520 € | 3.050 € |       | 1 | 6 | 76.7 | 0.35 |
| 160/220x 90         | T2151158 |     |    | 2.350 € | 2.390 € | 2.560 € |       | 1 | 4 | 62.7 | 0.31 |
| 160/210/260x 90     | T2151159 |     |    | 2.580 € | 2.650 € | 2.980 € |       | 1 | 5 | 70.7 | 0.33 |
| 160/210/260/310x 90 | T2151161 |     |    | 2.820 € | 2.880 € | 3.360 € |       | 1 | 6 | 83.7 | 0.45 |
| 180/240x 90         | T2151171 |     |    | 2.450 € | 2.510 € | 2.865 € |       | 1 | 4 | 68.5 | 0.38 |
| 180/230/280x 90     | T2151172 |     |    | 2.660 € | 2.720 € | 3.160 € |       | 1 | 5 | 76.5 | 0.40 |
| 180/240x100         | T2151179 |     |    | 2.580 € | 2.640 € | 2.995 € |       | 1 | 4 | 73   | 0.40 |
| 180/230/280x100     | T2151181 |     |    | 2.790 € | 2.850 € | 3.290 € |       | 1 | 5 | 81.6 | 0.46 |

**Woody Glass**

Glass top 10 mm thk HPL extensions 10 mm thk

|                     |          |     |    | GVB     | GVC     | GVD     |       |   |   |       |      |
|---------------------|----------|-----|----|---------|---------|---------|-------|---|---|-------|------|
| 120x 80             | T2150121 | LFI | MI | 1.376 € | 1.513 € | 1.589 € | FM-M2 | 1 | 3 | 55.5  | 0.23 |
| 140x 90             | T2150139 |     |    | 1.441 € | 1.586 € | 1.665 € |       | 1 | 3 | 67    | 0.27 |
| 160x 90             | T2150161 |     |    | 1.584 € | 1.742 € | 1.829 € |       | 1 | 3 | 72.7  | 0.29 |
| 180x 90             | T2150179 |     |    | 1.980 € | 2.090 € | 2.150 € |       | 1 | 3 | 78    | 0.34 |
| 180x100             | T2150181 |     |    | 2.080 € | 2.190 € | 2.250 € |       | 1 | 3 | 86    | 0.34 |
| 120/170x 80         | T2158120 |     |    | 1.532 € | 1.685 € | 1.769 € |       | 1 | 4 | 63.5  | 0.27 |
| 140/200x 90         | T2158139 |     |    | 1.351 € | 1.449 € | 1.527 € |       | 1 | 4 | 75.15 | 0.28 |
| 140/190/240x 90     | T2158140 |     |    | 2.001 € | 2.201 € | 2.311 € |       | 1 | 5 | 83.15 | 0.35 |
| 140/190/240/290x 90 | T2158143 | LFI | MI | 2.302 € | 2.483 € | 2.707 € | FM-M2 | 1 | 5 | 91.15 | 0.35 |
| 160/220x 90         | T2158158 |     |    | 1.860 € | 1.930 € | 2.460 € |       | 1 | 4 | 80.7  | 0.31 |
| 160/210/260x 90     | T2158159 |     |    | 2.160 € | 2.380 € | 2.680 € |       | 1 | 5 | 88.7  | 0.33 |
| 160/210/260/310x 90 | T2158160 |     |    | 2.757 € | 3.034 € | 3.184 € |       | 1 | 6 | 96.7  | 0.45 |
| 180/240x 90         | T2158171 |     |    | 1.910 € | 2.000 € | 2.550 € |       | 1 | 4 | 86    | 0.38 |
| 180/230/280x 90     | T2158172 |     |    | 2.360 € | 2.540 € | 2.670 € |       | 1 | 5 | 94    | 0.40 |
| 180/240x100         | T2158179 |     |    | 2.040 € | 2.130 € | 2.390 € |       | 1 | 4 | 94    | 0.40 |
| 180/230/280x100     | T2158180 |     |    | 2.490 € | 2.670 € | 2.830 € |       | 1 | 5 | 102   | 0.46 |

**Woody Ceramic**

Ceramic top 14 mm thk HPL extensions

|                     |          |     |    | GKA     | GKB     | GMA     |       |   |   |       |      |
|---------------------|----------|-----|----|---------|---------|---------|-------|---|---|-------|------|
| 120x 80             | T2150121 |     |    | 1.770 € | 1.840 € | 2.050 € |       | 1 | 3 | 69    | 0.23 |
| 140x 90             | T2150139 |     |    | 2.040 € | 2.110 € | 2.310 € |       | 1 | 3 | 84.7  | 0.27 |
| 160x 90             | T2150161 |     |    | 2.240 € | 2.310 € | 2.480 € |       | 1 | 3 | 92.7  | 0.29 |
| 180x 90             | T2150179 |     |    | 2.400 € | 2.470 € | 2.810 € |       | 1 | 3 | 100.5 | 0.34 |
| 180x100             | T2150181 |     |    | 2.520 € | 2.590 € | 2.930 € |       | 1 | 3 | 111   | 0.34 |
| 120/170x 80         | T2158120 |     |    | 2.150 € | 2.268 € | 2.450 € |       | 1 | 4 | 77    | 0.27 |
| 140/200x 90         | T2158139 |     |    | 2.020 € | 2.131 € | 2.302 € |       | 1 | 4 | 92.7  | 0.28 |
| 140/190/240x 90     | T2158140 |     |    | 2.979 € | 3.134 € | 3.375 € |       | 1 | 5 | 100.7 | 0.35 |
| 140/190/240/290x 90 | T2158143 | LFI | MI | 3.300 € | 3.450 € | 3.670 € | FM-M2 | 1 | 6 | 108.7 | 0.35 |
| 160/220x 90         | T2158158 |     |    | 2.540 € | 2.590 € | 2.990 € |       | 1 | 3 | 100.7 | 0.31 |
| 160/210/260x 90     | T2158159 |     |    | 3.110 € | 3.208 € | 3.455 € |       | 1 | 5 | 108.7 | 0.33 |
| 160/210/260/310x 90 | T2158160 |     |    | 3.858 € | 4.054 € | 4.210 € |       | 1 | 6 | 116.7 | 0.45 |
| 180/240x 90         | T2158171 |     |    | 2.750 € | 2.850 € | 3.140 € |       | 1 | 4 | 108.5 | 0.38 |
| 180/230/280x 90     | T2158172 |     |    | 3.350 € | 3.440 € | 3.665 € |       | 1 | 5 | 116.5 | 0.40 |
| 180/240x100         | T2158179 |     |    | 2.900 € | 3.000 € | 3.290 € |       | 1 | 4 | 119   | 0.40 |
| 180/230/280x100     | T2158180 |     |    | 3.510 € | 3.600 € | 3.825 € |       | 1 | 5 | 127   | 0.46 |

**Note:**

For Glass or Crystal Ceramic tops, extensions Only in MDF or HPL - Table 180x100 NO Ceramic K26

**Frame finishes**

**Metal**

|           |   |
|-----------|---|
| <b>MI</b> | WHITE <b>BB</b> , BROWN <b>E6</b> , SAND <b>EC</b> , WHITE PEARL <b>EF</b> , GRAPHITE <b>EG</b> , BLACK <b>EN</b> |
|-----------|---|

**Legs finishes**

**Solid ashwood**

|            |  |
|------------|--|
| <b>LFI</b> | Ash wood stained BLACK <b>F04</b> , Ash wood stained WHITE <b>F05</b> , Ash wood stained CHERRY RED <b>F09</b> , Ash wood stained FLAMED WALNUT <b>F24</b> , Ash wood stained DARK BROWN <b>F26</b> , Ash wood stained NATURAL <b>F40</b> , Ash wood stained NATURAL OAK <b>F52</b> , Ash wood stained WHITENED <b>F60</b> , Ash wood stained DESERT <b>F61</b> , Ash wood stained LIGHT GREY <b>F62</b> , Ash wood stained DARK GREY <b>F63</b> |
|------------|--|

**Top and extensions finishes**

**Veneer**

|            |  |
|------------|--|
| <b>LII</b> | Stained BLACK <b>I04</b> , Stained WHITE <b>I05</b> , Stained CHERRY RED <b>I09</b> , Stained DARK BROWN <b>I26</b> , Stained NATURAL <b>I40</b> , Stained NATURAL OAK <b>I52</b> , Stained WHITENED <b>I60</b> , Stained DESERT <b>I61</b> , Stained LIGHT GREY <b>I62</b> , Stained DARK GREY <b>I63</b> |
|------------|--|

**Top and extensions finishes**

**HPL**

|            |  |            |   |
|------------|--|------------|---|
| <b>HH1</b> | WHITE/Black Core <b>HB4</b> , BLACK/Black Core <b>HN4</b>  | <b>HH2</b> | CEMENT/Black Core <b>HC6</b> , CORTEN/Brown Core <b>HC7</b> , DARK GREY/Black Core <b>HGW</b> |
| <b>HH3</b> | ST WHITE/White Core <b>AB4</b> , ST SAND/Sand Core <b>ACR</b> , ST GRAPHITE GREY/ Grafite Core <b>AGD</b> , ST BLACK/Black Core <b>AN4</b> , ST TORTORA/Tortora Core <b>ATR</b> , ST RED NAMIB/Red Core <b>FAM</b> , ST YELLOW EVORA/Yellow Core <b>FGO</b> , ST RED BULGARO/Red Core <b>FRB</b> , ST GREEN KITAMI/Green Core <b>FVK</b> |            |   |

**Top finishes**

**Glass**

|            |   |
|------------|---|
| <b>GVC</b> | MATT GRAFITE ANTISCRATCH <b>J31</b> , MATT SAND ANTISCRATCH <b>J32</b>  |
| <b>GVD</b> | EXTRA CLEAR MATT WHITE ANTISCRATCH <b>J41</b>   |
| <b>GVB</b> | EXTRA CLEAR GLOSSY WHITE <b>J21</b> , EXTRA CLEAR GLOSSY CHERRY RED <b>J25</b> , EXTRA CLEAR GLOSSY BLUE SAPPHIRE <b>J26</b> , EXTRA CLEAR GLOSSY BLUE TURQUOISE <b>J27</b> |

**Crystal Ceramic and Ceramic**

|            |   |
|------------|---|
| <b>GKA</b> | CHARCOAL SAVOIA <b>K11</b> , CEMENT SAVOIA <b>K12</b>   |
| <b>GKB</b> | WHITE CALCE <b>K24</b> , BLACK CALCE <b>K25</b> , TORTORA CALCE <b>K26</b> , PIASENTINA STONE TAUPE Materica <b>K55</b> , TERRACOTTA Matt <b>K90</b> , MATT GREEN <b>K91</b>  |
| <b>GMA</b> | MARBLE CALACATTA GLOSSY WHITE <b>K32</b> , BLACK GREEK MARBLE <b>K33</b> , MARBLE GLOSSY NOIR DESIR <b>K35</b> , MARBLE CALACATTA MATT WHITE <b>K42</b> , MARBLE MATT NOIR DESIR <b>K45</b> , MARBLE MATT GREEN TINOS <b>K46</b> , MARBLE STATUARIO WHITE MATT <b>K47</b> , MARBLE CALACAT BLACK Bush Hammered <b>K50</b> |

**Extensions finishes MDF, ONLY for Glass Top**

**Lacquered MDF**

|            |   |
|------------|---|
| <b>LMI</b> | GRAPHITE GREY <b>G02</b> , BLACK <b>G04</b> , WHITE <b>G05</b> , SAND <b>G07</b> , BROWN <b>G41</b> |
|------------|---|

**Optionals:**

|              |                      | Value   | Options/notes  |
|--------------|----------------------|---------|--|
| <b>FM-M2</b> | Indoor matt metal M2 | + 105 € | ASH GREY <b>ES</b> , BLUE SAPPHIRE <b>EE</b> , BLUE TURQUOISE <b>EH</b> , BRONZE <b>E2</b> , BULGARO RED <b>FP</b> , CHERRY RED <b>EQ</b> , DARK GREEN <b>EL</b> , FACEPOWDER PINK <b>E8</b> , FANGO <b>E3</b> , GOLDEN YELLOW <b>EO</b> , LIGHT BLUE <b>EO</b> , LIGHT GREY <b>ET</b> , OCEAN BLUE <b>E1</b> , OCHER YELLOW <b>E7</b> , PAPAYA ORANGE <b>EA</b> , PASTEL YELLOW <b>E4</b> , PINE GREEN <b>EJ</b> , RED <b>ER</b> , SAGE GREEN <b>E9</b> |

**120x 80**

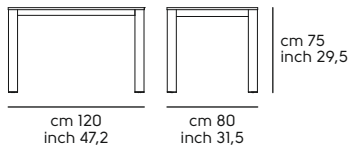

**140x 90**

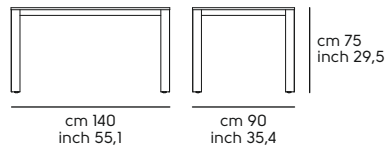

**160x 90**

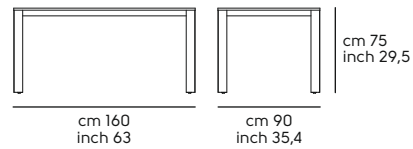

**180x 90**

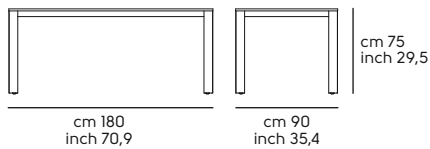

**180x100**

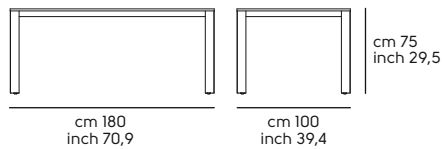

**120/170x 80**

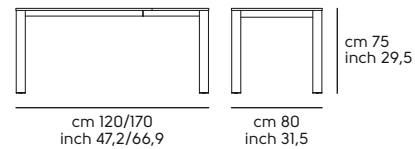

**140/200x 90**

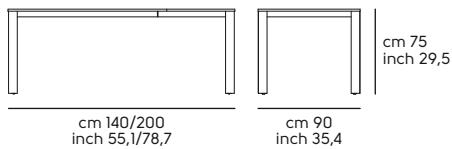

**140/190/240x 90**

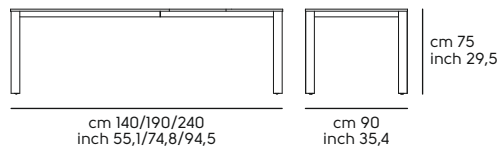

**140/190/240/290x 90**

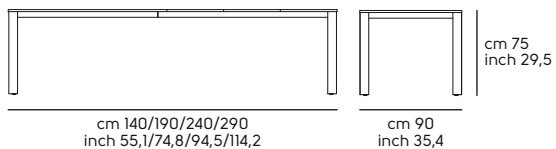

**160/220x 90**

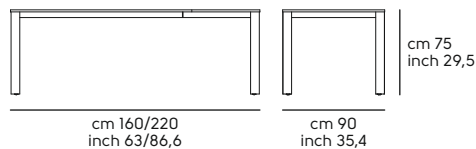

**160/210/260x 90**

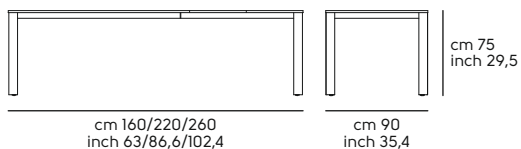

**160/210/260/310x 90**

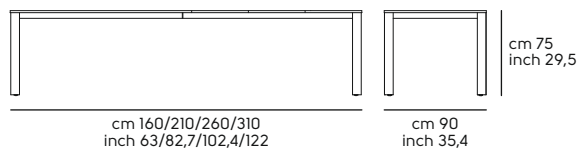

**180/240x 90**

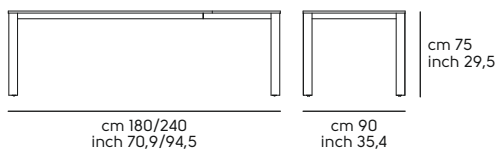

**180/230/280x 90**

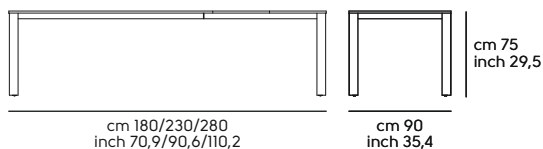

**180/240x100**

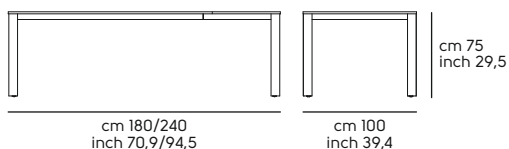

**180/230/280x100**

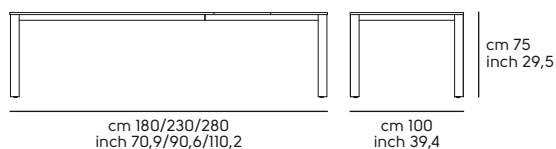

# Zeus design Maurizio e Silvia Varsi

## Table Zeus

Frame in: metal or lacquered solid ash



| Version | Code | Legs | Frame | Top | Optional | Q.ty | boxes | Kg | M <sup>3</sup> |
|---------|------|------|-------|-----|----------|------|-------|----|----------------|
|---------|------|------|-------|-----|----------|------|-------|----|----------------|

### Zeus Veneer

Top 30 mm. thk

|                    |          |    |    | L12     |  |   |   |     |      |
|--------------------|----------|----|----|---------|--|---|---|-----|------|
| MT 200x106         | T0302200 |    |    | 2.430 € |  | 1 | 5 | 94  | 0.41 |
| MT 250x106         | T0302250 | M1 | M1 | 2.712 € |  | 1 | 5 | 112 | 0.44 |
| MT 200/250/300x106 | T0303200 |    |    | 3.127 € |  | 1 | 6 | 99  | 0.53 |

### Zeus wood

Top 40 mm. thk

|            |          |    |    | LS1     | LS2     |  |   |   |     |      |
|------------|----------|----|----|---------|---------|--|---|---|-----|------|
| MT 200x106 | T0302200 | M1 | M1 | 3.956 € | 4.072 € |  | 1 | 4 | 94  | 0.37 |
| MT 250x106 | T0302250 |    |    | 4.620 € | 4.735 € |  | 1 | 4 | 113 | 0.44 |

### Zeus Glass

Top 12 mm. thk

|            |          |    |    | GVB     |  |   |   |     |      |
|------------|----------|----|----|---------|--|---|---|-----|------|
| MT 200x106 | T0302200 | M1 | M1 | 2.038 € |  | 1 | 4 | 118 | 0.37 |
| MT 250x106 | T0302250 |    |    | 2.438 € |  | 1 | 4 | 143 | 0.26 |

### Zeus Ceramic

Top 36 mm. thk

|            |          |    |    | GMA     |  |   |   |     |      |
|------------|----------|----|----|---------|--|---|---|-----|------|
| MT 200x100 | T0300200 | M1 | M1 | 3.127 € |  | 1 | 5 | 127 | 0.37 |
| MT 250x100 | T0300250 |    |    | 3.554 € |  | 1 | 5 | 153 | 0.26 |

### Zeus Marble

Top 20 mm. thk

|            |          |    |    | GMM     |  |   |   |     |      |
|------------|----------|----|----|---------|--|---|---|-----|------|
| MT 200x100 | T0300200 | M1 | M1 | 4.086 € |  | 1 | 4 | 127 | 0.37 |

### Zeus Veneer

Top 30 mm. thk

|            |          |     |     | L12     |  |   |   |    |      |
|------------|----------|-----|-----|---------|--|---|---|----|------|
| LG 200x106 | T0307200 |     |     | 3.357 € |  | 1 | 5 | 75 | 0.39 |
| LG 250x106 | T0307250 | L12 | L12 | 3.664 € |  | 1 | 5 | 90 | 0.44 |

### Zeus wood

Top 40 mm. thk

|            |          |     |     | LS1     | LS2     |  |   |   |    |      |
|------------|----------|-----|-----|---------|---------|--|---|---|----|------|
| LG 200x106 | T0307200 | L12 | L12 | 4.250 € | 4.365 € |  | 1 | 4 | 75 | 0.36 |
| LG 250x106 | T0307250 | L12 | L12 | 5.155 € | 5.271 € |  | 1 | 4 | 89 | 0.44 |

**Zeus Glass**

Top 12 mm. thk

|            |          |     |     | GVB     |  |   |   |     |      |
|------------|----------|-----|-----|---------|--|---|---|-----|------|
| LG 200x106 | T0307200 | LI2 | LI2 | 3.127 € |  | 1 | 4 | 87  | 0.26 |
| LG 250x106 | T0307250 |     |     | 3.639 € |  | 1 | 4 | 106 | 0.37 |

**Zeus Ceramic**

Top 36 mm. thk

|            |          |     |     | GMA     |  |   |   |     |      |
|------------|----------|-----|-----|---------|--|---|---|-----|------|
| LG 200x100 | T0305200 | LI2 | LI2 | 3.918 € |  | 1 | 5 | 108 | 0.37 |
| LG 250x100 | T0305250 |     |     | 4.468 € |  | 1 | 5 | 116 | 0.37 |

**Zeus Marble**

Top 20 mm. thk

|            |          |     |     | GMM     |  |   |   |     |      |
|------------|----------|-----|-----|---------|--|---|---|-----|------|
| LG 200x100 | T0305200 | LI2 | LI2 | 5.019 € |  | 1 | 4 | 108 | 0.37 |

**Frame finishes**

**Metal**

|           |             |
|-----------|-------------|
| <b>MI</b> | GRAPHITE EG |
|-----------|-------------|

**Veneer**

|            |                   |
|------------|-------------------|
| <b>LI2</b> | FLAMED WALNUT I24 |
|------------|-------------------|

**Legs finishes**

**Metal**

|           |             |
|-----------|-------------|
| <b>MI</b> | GRAPHITE EG |
|-----------|-------------|

**Veneer**

|            |                   |
|------------|-------------------|
| <b>LI2</b> | FLAMED WALNUT I24 |
|------------|-------------------|

**Top finishes**

**Veneer**

|            |                                    |
|------------|------------------------------------|
| <b>LI2</b> | NATURAL OAK I22, FLAMED WALNUT I24 |
|------------|------------------------------------|

**Solid ashwood**

|            |                            |
|------------|----------------------------|
| <b>LS1</b> | IM OAK STRAIGHT EDGE WR1   |
| <b>LS2</b> | SOLID WALNUT BARK EDGE WN1 |

**Glossy Glass**

|            |                             |
|------------|-----------------------------|
| <b>GVB</b> | EXTRA CLEAR TRANSPARENT J01 |
|------------|-----------------------------|

**Crystal Ceramic and Ceramic**

|            |   |
|------------|---|
| <b>GMA</b> | MARBLE CALACATTA GLOSSY WHITE K32, BLACK GREEK MARBLE K33, MARBLE GLOSSY NOIR DESIR K35, MARBLE CALACATTA MATT WHITE K42, MARBLE MATT NOIR DESIR K45, MARBLE MATT GREEN TINOS K46 |
|------------|---|

**Marble**

|            |  |
|------------|--|
| <b>GMM</b> | BEIGE TRAVERTINO ROMANO MB2, WHITE CALACATTA VAGLI MB4, BLACK MARQUINIA MN4, GREEN TINOS MVE |
|------------|--|

**200x106**

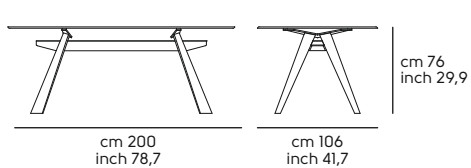

**250x106**

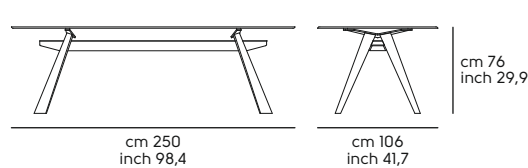

**200/250/300x106**

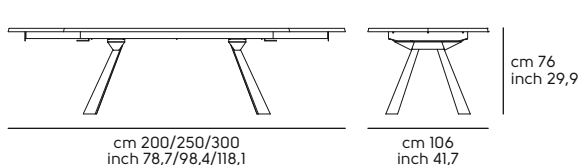

# Coffee Table

# Apelle design Beatriz Sempere

## Coffee Table APELLE CHIC

Frame in: metal



| Version | Code | Mod. | Frame | Top | Optional | Q.ty | boxes | Kg | M <sup>3</sup> |
|---------|------|------|-------|-----|----------|------|-------|----|----------------|
|---------|------|------|-------|-----|----------|------|-------|----|----------------|

### Apelle Chic Hide

Top 6 mm. thk

|                    |          |     |    | CU    | CT    |                |   |   |     |      |
|--------------------|----------|-----|----|-------|-------|----------------|---|---|-----|------|
| APELLE CHIC H43_CU | T1000C43 | H43 | M1 | 210 € | 238 € | FM-M2<br>FM-M4 | 1 | 1 | 6   | 0.08 |
| APELLE CHIC H63_CU | T1000C63 | H63 | M1 | 236 € | 261 € | FM-M2<br>FM-M4 | 1 | 1 | 7   | 0.12 |
| APELLE CHIC H73_CU | T1000C73 | H73 | M1 | 267 € | 300 € | FM-M2<br>FM-M4 | 1 | 1 | 7.5 | 0.15 |

### Apelle Chic Ceramic

Top 8 mm. thk

|                    |          |     |    | GKA   | GKB   | GMA   |                |   |   |     |      |
|--------------------|----------|-----|----|-------|-------|-------|----------------|---|---|-----|------|
| APELLE CHIC H43_KR | T1000H43 | H43 | M1 | 215 € | 234 € | 246 € | FM-M2<br>FM-M4 | 1 | 1 | 6   | 0.08 |
| APELLE CHIC H63_KR | T1000H63 | H63 | M1 | 240 € | 262 € | 282 € | FM-M2<br>FM-M4 | 1 | 1 | 7   | 0.12 |
| APELLE CHIC H73_KR | T1000H73 | H73 | M1 | 269 € | 280 € | 302 € | FM-M2<br>FM-M4 | 1 | 1 | 7.5 | 0.15 |

## Frame finishes

### Metal

|           |  |
|-----------|--|
| <b>MI</b> | WHITE <b>BB</b> , INDUSTRIAL <b>E5</b> , BROWN <b>E6</b> , SAND <b>EC</b> , WHITE PEARL <b>EF</b> , GRAPHITE <b>EG</b> , BLACK <b>EN</b> |
|-----------|--|

## Top finishes

### Hide

|           |             |
|-----------|-------------|
| <b>CU</b> | HIDE        |
| <b>CT</b> | TUSCAN HIDE |

### Crystal Ceramic and Ceramic

|            |  |
|------------|--|
| <b>GKA</b> | CHARCOAL SAVOIA <b>K11</b> , CEMENT SAVOIA <b>K12</b>  |
| <b>GKB</b> | WHITE CALCE <b>K24</b> , BLACK CALCE <b>K25</b> , TORTORA CALCE <b>K26</b> , PIASENTINA STONE TAUPE Materica <b>K55</b> , TERRACOTTA Matt <b>K90</b> , MATT GREEN <b>K91</b> |

### Crystal Ceramic and Ceramic

|            |   |
|------------|---|
| <b>GMA</b> | MARBLE CALACATTA GLOSSY WHITE <b>K32</b> , BLACK GREEK MARBLE <b>K33</b> , MARBLE GLOSSY NOIR DESIR <b>K35</b> , MARBLE CALACATTA MATT WHITE <b>K42</b> , MARBLE MATT NOIR DESIR <b>K45</b> , MARBLE MATT GREEN TINOS <b>K46</b> , MARBLE STATUARIO WHITE MATT <b>K47</b> , MARBLE CALACAT BLACK Bush Hammered <b>K50</b> |
|------------|---|

### Optionals:

|              |                        | Value   | Options/notes  |
|--------------|------------------------|---------|--|
| <b>FM-M2</b> | Indoor matt metal M2   | + 93 €  | ASH GREY <b>ES</b> , BLUE SAPPHIRE <b>EE</b> , BLUE TURQUOISE <b>EH</b> , BRONZE <b>E2</b> , BULGARO RED <b>FP</b> , CHERRY RED <b>EQ</b> , DARK GREEN <b>EL</b> , FACEPOWDER PINK <b>E8</b> , FANGO <b>E3</b> , GOLDEN YELLOW <b>EO</b> , LIGHT BLUE <b>EO</b> , LIGHT GREY <b>ET</b> , OCEAN BLUE <b>E1</b> , OCHER YELLOW <b>E7</b> , PAPAYA ORANGE <b>EA</b> , PASTEL YELLOW <b>E4</b> , PINE GREEN <b>EJ</b> , RED <b>ER</b> , SAGE GREEN <b>E9</b> |
| <b>FM-M4</b> | Indoor glossy Metal M4 | + 108 € | BLACK NICKEL <b>DZ</b> , CHAMPAGNE GOLD <b>DG</b> , GOLDEN BRONZE <b>DB</b> , MATT BLACK NICKEL <b>DY</b> , MATT GOLDEN BRONZE <b>DC</b> , PINK GOLD <b>DR</b>   |

### Apelle Chic H43

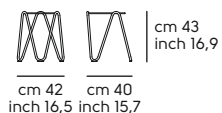

### Apelle Chic H63

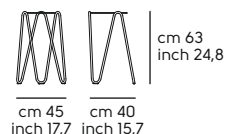

### Apelle Chic H73

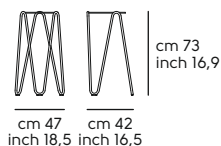

## Coffee Table APELLE CT

Frame in: metal



| Version | Code | Mod. | Frame | Top | Optional | Q.ty | boxes | Kg | M <sup>3</sup> |
|---------|------|------|-------|-----|----------|------|-------|----|----------------|
|---------|------|------|-------|-----|----------|------|-------|----|----------------|

### Apelle Hide

Top 6 mm. thk

|           |          |    |    | CU    | CT    |                |   |   |   |      |
|-----------|----------|----|----|-------|-------|----------------|---|---|---|------|
| APELLE CT | T10000CT | CT | MI | 224 € | 267 € | FM-M2<br>FM-M4 | 1 | 1 | 7 | 0.09 |

## Coffee Table APELLE TRIO

Frame in: metal



| Version | Code | Mod. | Frame | Top | Optional | Q.ty | boxes | Kg | M³ |
|---------|------|------|-------|-----|----------|------|-------|----|----|
|---------|------|------|-------|-----|----------|------|-------|----|----|

### Apelle Hide

Top 6 mm. thk

|                |          |    |    | CU    | CT    |                |   |   |    |      |
|----------------|----------|----|----|-------|-------|----------------|---|---|----|------|
| APELLE TRIO_CU | T1000CTR | TR | M1 | 437 € | 530 € | FM-M2<br>FM-M4 | 1 | 1 | 15 | 0.25 |

### Apelle Ceramic

Top 8 mm. thk

|                |          |    |    | GKA   | GKB   | GMA   |                |   |   |    |      |
|----------------|----------|----|----|-------|-------|-------|----------------|---|---|----|------|
| APELLE TRIO_KR | T1000HTR | TR | M1 | 565 € | 631 € | 658 € | FM-M2<br>FM-M4 | 1 | 1 | 15 | 0.25 |

### Frame finishes

#### Metal

|           |   |
|-----------|---|
| <b>MI</b> | WHITE <b>BB</b> , BROWN <b>E6</b> , SAND <b>EC</b> , WHITE PEARL <b>EF</b> , GRAPHITE <b>EG</b> , BLACK <b>EN</b> |
|-----------|---|

### Top finishes

#### Hide

|           |             |
|-----------|-------------|
| <b>CU</b> | HIDE        |
| <b>CT</b> | TUSCAN HIDE |

#### Crystal Ceramic and Ceramic

|            |  |
|------------|--|
| <b>GKA</b> | CHARCOAL SAVOIA <b>K11</b> , CEMENT SAVOIA <b>K12</b>  |
| <b>GKB</b> | WHITE CALCE <b>K24</b> , BLACK CALCE <b>K25</b> , TORTORA CALCE <b>K26</b> , PIASENTINA STONE TAUPE Materica <b>K55</b> , TERRACOTTA Matt <b>K90</b> , MATT GREEN <b>K91</b> |

#### Crystal Ceramic and Ceramic

|            |   |
|------------|---|
| <b>GMA</b> | MARBLE CALACATTA GLOSSY WHITE <b>K32</b> , BLACK GREEK MARBLE <b>K33</b> , MARBLE GLOSSY NOIR DESIR <b>K35</b> , MARBLE CALACATTA MATT WHITE <b>K42</b> , MARBLE MATT NOIR DESIR <b>K45</b> , MARBLE MATT GREEN TINOS <b>K46</b> , MARBLE STATUARIO WHITE MATT <b>K47</b> , MARBLE CALACAT BLACK Bush Hammered <b>K50</b> |
|------------|---|

### Optionals:

|              |                        | Value   | Options/notes  |
|--------------|------------------------|---------|--|
| <b>FM-M2</b> | Indoor matt metal M2   | + 93 €  | ASH GREY <b>ES</b> , BLUE SAPPHIRE <b>EE</b> , BLUE TURQUOISE <b>EH</b> , BRONZE <b>E2</b> , BULGARO RED <b>FP</b> , CHERRY RED <b>EQ</b> , DARK GREEN <b>EL</b> , FACEPOWDER PINK <b>E8</b> , FANGO <b>E3</b> , GOLDEN YELLOW <b>EO</b> , LIGHT BLUE <b>EO</b> , LIGHT GREY <b>ET</b> , OCEAN BLUE <b>EI</b> , OCHER YELLOW <b>E7</b> , PAPAYA ORANGE <b>EA</b> , PASTEL YELLOW <b>E4</b> , PINE GREEN <b>EJ</b> , RED <b>ER</b> , SAGE GREEN <b>E9</b> |
| <b>FM-M4</b> | Indoor glossy Metal M4 | + 108 € | BLACK NICKEL <b>DZ</b> , CHAMPAGNE GOLD <b>DG</b> , GOLDEN BRONZE <b>DB</b> , MATT BLACK NICKEL <b>DY</b> , MATT GOLDEN BRONZE <b>DC</b> , PINK GOLD <b>DR</b>   |

### Apelle CT

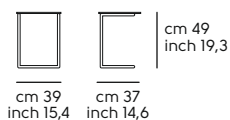

### Apelle TR

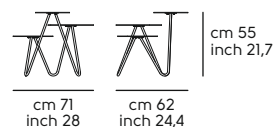

# Bloom design Studio Pastina

## Coffee Table BLOOM

Frame in: metal upholstered



| Version | Code | Mod. | Frame and Top | Upholstery |  |  |  |  |  |  |  |  | Optional | Q.ty | boxes | Kg | M <sup>3</sup> |
|---------|------|------|---------------|------------|--|--|--|--|--|--|--|--|----------|------|-------|----|----------------|
|---------|------|------|---------------|------------|--|--|--|--|--|--|--|--|----------|------|-------|----|----------------|

### Bloom Top Metal

Top 4 mm. thk

|                    |          |     |    | TA    | TB    | TC    | TD    | TE    | SF    | SV    | COM   | COL   |                |   |   |    |      |
|--------------------|----------|-----|----|-------|-------|-------|-------|-------|-------|-------|-------|-------|----------------|---|---|----|------|
| BLOOM H40 D. 70_MT | T204ID70 | H40 | M1 | 586 € | 606 € | 657 € | 660 € | 686 € | 669 € | 692 € | 586 € | 657 € | FM-M2<br>IM-M2 | 1 | 2 | 13 | 0.15 |
| BLOOM H50 D. 60_MT | T204ID60 | H50 | M1 | 528 € | 544 € | 582 € | 574 € | 596 € | 586 € | 606 € | 528 € | 582 € | FM-M2<br>IM-M2 | 1 | 2 | 13 | 0.12 |

### Bloom Top HPL -HH1

Top 10 mm. thk

|                 |           |     |          | TA    | TB    | TC    | TD    | TE    | SF    | SV    | COM   | COL   |       |   |   |    |      |
|-----------------|-----------|-----|----------|-------|-------|-------|-------|-------|-------|-------|-------|-------|-------|---|---|----|------|
| BLOOM H40 D. 70 | T2040D70_ | H40 | M1 - HH1 | 594 € | 616 € | 668 € | 671 € | 700 € | 682 € | 703 € | 594 € | 668 € | FM-M2 | 1 | 2 | 13 | 0.15 |
| BLOOM H50 D. 60 | T2040D60_ | H50 | M1 - HH1 | 520 € | 542 € | 592 € | 591 € | 614 € | 594 € | 627 € | 520 € | 592 € | FM-M2 | 1 | 2 | 13 | 0.12 |

### Bloom Top HPL -HH2

Top 10 mm. thk

|                 |           |     |          | TA    | TB    | TC    | TD    | TE    | SF    | SV    | COM   | COL   |                |   |   |    |      |
|-----------------|-----------|-----|----------|-------|-------|-------|-------|-------|-------|-------|-------|-------|----------------|---|---|----|------|
| BLOOM H40 D. 70 | T2040D70_ | H40 | M1 - HH2 | 594 € | 616 € | 668 € | 671 € | 700 € | 682 € | 703 € | 594 € | 668 € | FM-M2<br>FH-H2 | 1 | 2 | 13 | 0.15 |
| BLOOM H50 D. 60 | T2040D60_ | H50 | M1 - HH2 | 520 € | 542 € | 592 € | 591 € | 614 € | 594 € | 627 € | 520 € | 592 € | FM-M2<br>FH-H2 | 1 | 2 | 13 | 0.12 |

### Bloom Top HPL -HH3

Top 10 mm. thk

|                 |           |     |          | TA    | TB    | TC    | TD    | TE    | SF    | SV    | COM   | COL   |                |   |   |    |      |
|-----------------|-----------|-----|----------|-------|-------|-------|-------|-------|-------|-------|-------|-------|----------------|---|---|----|------|
| BLOOM H40 D. 70 | T2040D70_ | H40 | M1 - HH3 | 594 € | 616 € | 668 € | 671 € | 700 € | 682 € | 703 € | 594 € | 668 € | FM-M2<br>FH-H3 | 1 | 2 | 13 | 0.15 |
| BLOOM H50 D. 60 | T2040D60_ | H50 | M1 - HH3 | 520 € | 542 € | 592 € | 591 € | 614 € | 594 € | 627 € | 520 € | 592 € | FM-M2<br>FH-H3 | 1 | 2 | 13 | 0.12 |

**Frame finishes****Metal**

|           |   |
|-----------|---|
| <b>MI</b> | WHITE <b>BB</b> , BROWN <b>E6</b> , SAND <b>EC</b> , WHITE PEARL <b>EF</b> , GRAPHITE <b>EG</b> , BLACK <b>EN</b> |
|-----------|---|

**Top finishes****Metal**

|           |   |
|-----------|---|
| <b>MI</b> | WHITE <b>BB</b> , BROWN <b>E6</b> , SAND <b>EC</b> , WHITE PEARL <b>EF</b> , GRAPHITE <b>EG</b> , BLACK <b>EN</b> |
|-----------|---|

**HPL**

|            |   |            |   |
|------------|---|------------|---|
| <b>HH1</b> | WHITE/Black Core <b>HB4</b> , BLACK/Black Core <b>HN4</b>   | <b>HH2</b> | CEMENT/Black Core <b>HC6</b> , CORTEN/Brown Core <b>HC7</b> , DARK GREY/Black Core <b>HGW</b> |
| <b>HH3</b> | ST WHITE/White Core <b>AB4</b> , ST SAND/Sand Core <b>ACR</b> , ST GRAPHITE GREY/Grafite Core <b>AGD</b> , ST BLACK/Black Core <b>AN4</b> , ST TORTORA/Tortora Core <b>ATR</b> , ST RED NAMIB/Red Core <b>FAM</b> , ST YELLOW EVORA/Yellow Core <b>FGO</b> , ST RED BULGARO/Red Core <b>FRB</b> , ST GREEN KITAMI/Green Core <b>FVK</b> |            |   |



**Frame finishes****Upholstery**

|           |   |           |  |
|-----------|---|-----------|--|
| <b>TA</b> | FAUX LEATHER <b>Secret</b> , FABRIC <b>Mirage</b> , FABRIC <b>Cotton Club</b> , FABRIC <b>Renewed Loop</b>  | <b>TB</b> | FAUX LEATHER <b>Vintage</b> , FABRIC <b>Fenix Wool</b> , FABRIC <b>Visual</b> , FABRIC <b>Manhattan</b> , FABRIC <b>Novabuk</b> , FABRIC <b>Network</b> , FABRIC <b>Gyre</b> |
| <b>TC</b> | VELVET SUPERB, FABRIC <b>Second</b> , FABRIC <b>Main Line Flax</b> , FABRIC <b>Oceanic</b> , FABRIC <b>Jumper</b> , FABRIC <b>Flame</b> , FABRIC <b>Ouche</b> , FABRIC <b>Plain</b> , FABRIC <b>Gemma</b> , FABRIC <b>Caltagirone 114</b> | <b>TD</b> | FABRIC <b>Yoredale</b> , FABRIC <b>Remix 3</b>   |
| <b>TE</b> | FABRIC <b>Uniform Melange</b>   | <b>SF</b> | LEATHER <b>Fiore</b>   |
| <b>SV</b> | LEATHER <b>Vintage</b>  |           |  |

**COM/COL - Minimum Q.ty 1 pc. for each material. For weft or patterned fabrics see specific pages**

|  |                                       |  |                              |
|--|---------------------------------------|--|------------------------------|
|  <b>COM</b> | Base type H40: Mtl. 0.30 h. 1.40 Each |  <b>COL</b> | Type Base H40: Mq. 0.45 Each |
|--|---------------------------------------|--|------------------------------|

**COM/COL - Minimum Q.ty 1 pc. for each material. For weft or patterned fabrics see specific pages**

|  |                                       |  |                              |
|--|---------------------------------------|--|------------------------------|
|  <b>COM</b> | Base type H50: Mtl. 0.40 h. 1.40 Each |  <b>COL</b> | Type Base H50: Mq. 0.60 Each |
|--|---------------------------------------|--|------------------------------|

**Optionals:**

|              | Value  | Options/notes  |
|--------------|--------|--|
| <b>FM-M2</b> | + 69 € | ASH GREY <b>ES</b> , BLUE SAPPHIRE <b>EE</b> , BLUE TURQUOISE <b>EH</b> , BRONZE <b>E2</b> , BRONZE <b>EZ</b> + TRANSP., BULGARO RED <b>FP</b> , CHERRY RED <b>EQ</b> , DARK GREEN <b>EL</b> , FACEPOWDER PINK <b>E8</b> , FANGO <b>E3</b> , GOLDEN YELLOW <b>EO</b> , LIGHT BLUE <b>EO</b> , LIGHT GREY <b>ET</b> , OCEAN BLUE <b>E1</b> , OCHER YELLOW <b>E7</b> , PAPAYA ORANGE <b>EA</b> , PASTEL YELLOW <b>E4</b> , PINE GREEN <b>EJ</b> , RED <b>ER</b> , SAGE GREEN <b>E9</b> |
| <b>IM-M2</b> | + 69 € | ASH GREY <b>ES</b> , BLUE SAPPHIRE <b>EE</b> , BLUE TURQUOISE <b>EH</b> , BRONZE <b>EZ</b> + TRANSP., BULGARO RED <b>FP</b> , CHERRY RED <b>EQ</b> , DARK GREEN <b>EL</b> , FACEPOWDER PINK <b>E8</b> , FANGO <b>E3</b> , GOLDEN YELLOW <b>EO</b> , LIGHT BLUE <b>EO</b> , LIGHT GREY <b>ET</b> , OCEAN BLUE <b>E1</b> , OCHER YELLOW <b>E7</b> , PAPAYA ORANGE <b>EA</b> , PASTEL YELLOW <b>E4</b> , PINE GREEN <b>EJ</b> , RED <b>ER</b> , SAGE GREEN <b>E9</b>                    |
| <b>FH-H2</b> | + 16 € | CEMENT/Black Core <b>HC6</b> , CORTEN/Brown Core <b>HC7</b> , DARK GREY/Black Core <b>HGW</b>  |
| <b>FH-H3</b> | + 22 € | ST BLACK/Black Core <b>AN4</b> , ST GRAPHITE GREY/Grafite Core <b>AGD</b> , ST GREEN KITAMI/Green Core <b>FVK</b> , ST RED BULGARO/Red Core <b>FRB</b> , ST RED NAMIB/Red Core <b>FAM</b> , ST SAND/Sand Core <b>ACR</b> , ST TORTORA/Tortora Core <b>ATR</b> , ST WHITE/White Core <b>AB4</b> , ST YELLOW EVORA/Yellow Core <b>FGO</b>  |

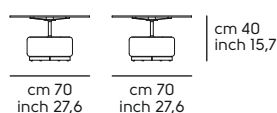
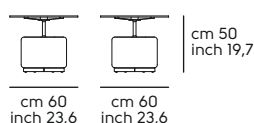
**Bloom H40****Bloom H50**

# Bolle design Paola Navone

## Coffee Table BOLLE IN

Frame in: metal (IN)



| Version | Code | Mod. | Frame | Top | Optional | Q.ty | boxes | Kg | M³ |
|---------|------|------|-------|-----|----------|------|-------|----|----|
|---------|------|------|-------|-----|----------|------|-------|----|----|

### Bolle HPL

Top 10 mm. thk

|               |          |      |    | HH1   | HH2   | HH3   |                |   |   |      |      |
|---------------|----------|------|----|-------|-------|-------|----------------|---|---|------|------|
| BOLLE D. 60   | T2200D60 | D60  | M1 | 383 € | 404 € | 426 € | FM-M2<br>PD-FO | 1 | 2 | 11   | 0.15 |
| BOLLE 100x100 | T2200Q10 | Q100 | M1 | 596 € | 726 € | 848 € | FM-M2<br>PD-FO | 1 | 2 | 20.5 | 0.33 |

| Version | Code | Mod. | Frame | Top | Optional | Q.ty | boxes | Kg | M³ |
|---------|------|------|-------|-----|----------|------|-------|----|----|
|---------|------|------|-------|-----|----------|------|-------|----|----|

### Bolle Metal

Top 4 mm. thk

|                  |          |      |    | M1    | M2    |                |   |   |      |      |
|------------------|----------|------|----|-------|-------|----------------|---|---|------|------|
| BOLLE D. 60 MT   | T2201D60 | D60  | M1 | 229 € | 253 € | FM-M2<br>PD-FO | 1 | 2 | 14   | 0.15 |
| BOLLE 100x100 MT | T2201Q10 | Q100 | M1 | 515 € | 546 € | FM-M2<br>PD-FO | 1 | 2 | 30.5 | 0.33 |

| Version | Code | Mod. | Frame | Top | Optional | Q.ty | boxes | Kg | M³ |
|---------|------|------|-------|-----|----------|------|-------|----|----|
|---------|------|------|-------|-----|----------|------|-------|----|----|

### Bolle Marble

Top 20 mm. thk

|                  |          |      |    | GMM     |                |   |   |      |      |
|------------------|----------|------|----|---------|----------------|---|---|------|------|
| BOLLE D. 60 MR   | T2202D60 | D60  | M1 | 614 €   | FM-M2<br>PD-FO | 1 | 2 | 20.5 | 0.15 |
| BOLLE 100x100 MR | T2202Q10 | Q100 | M1 | 1.539 € | FM-M2<br>PD-FO | 1 | 2 | 59.5 | 0.33 |

### Frame and Top finishes

#### Metal

|           |  |
|-----------|--|
| <b>M1</b> | WHITE <b>BB</b> , INDUSTRIAL <b>E5</b> , BROWN <b>E6</b> , SAND <b>EC</b> , WHITE PEARL <b>EF</b> , GRAPHITE <b>EG</b> , BLACK <b>EN</b>   |
| <b>M2</b> | LIGHT BLUE <b>E0</b> , OCEAN BLUE <b>E1</b> , BRONZE <b>E2</b> , FANGO <b>E3</b> , PASTEL YELLOW <b>E4</b> , OCHER YELLOW <b>E7</b> , FACEPOWDER PINK <b>E8</b> , SAGE GREEN <b>E9</b> , PAPAYA ORANGE <b>EA</b> , BLUE SAPPHIRE <b>EE</b> , BLUE TURQUOISE <b>EH</b> , PINE GREEN <b>EJ</b> , DARK GREEN <b>EL</b> , GOLDEN YELLOW <b>EO</b> , CHERRY RED <b>EQ</b> , RED <b>ER</b> , ASH GREY <b>ES</b> , LIGHT GREY <b>ET</b> , BULGARO RED <b>FP</b> |

## Top finishes

### HPL

|            |   |
|------------|---|
| <b>HH1</b> | WHITE/Black Core <b>HB4</b> , BLACK/Black Core <b>HN4</b>   |
| <b>HH2</b> | CEMENT/Black Core <b>HC6</b> , CORTEN/Brown Core <b>HC7</b> , DARK GREY/Black Core <b>HGW</b>   |
| <b>HH3</b> | ST WHITE/White Core <b>AB4</b> , ST SAND/Sand Core <b>ACR</b> , ST GRAPHITE GREY/Grafite Core <b>AGD</b> , ST BLACK/Black Core <b>AN4</b> , ST TORTORA/Tortora Core <b>ATR</b> , ST RED NAMIB/Red Core <b>FAM</b> , ST YELLOW EVORA/Yellow Core <b>FGO</b> , ST RED BULGARO/Red Core <b>FRB</b> , ST GREEN KITAMI/Green Core <b>FVK</b> |

### Marble

|            |   |
|------------|---|
| <b>GMM</b> | BEIGE TRAVERTINO ROMANO <b>MB2</b> , WHITE CALACATTA VAGLI <b>MB4</b> , BLACK MARQUINIA <b>MN4</b> , GREEN TINOS <b>MVE</b> |
|------------|---|

### Optionals:

|              |                      | Value  | Options/notes  |
|--------------|----------------------|--------|--|
| <b>FM-M2</b> | Indoor matt metal M2 | + 83 € | ASH GREY <b>ES</b> , BLUE SAPPHIRE <b>EE</b> , BLUE TURQUOISE <b>EH</b> , BRONZE <b>E2</b> , BULGARO RED <b>FP</b> , CHERRY RED <b>EQ</b> , DARK GREEN <b>EL</b> , FACEPOWDER PINK <b>E8</b> , FANGO <b>E3</b> , GOLDEN YELLOW <b>EO</b> , LIGHT BLUE <b>EO</b> , LIGHT GREY <b>ET</b> , OCEAN BLUE <b>EI</b> , OCHER YELLOW <b>E7</b> , PAPAYA ORANGE <b>EA</b> , PASTEL YELLOW <b>E4</b> , PINE GREEN <b>EJ</b> , RED <b>ER</b> , SAGE GREEN <b>E9</b> |
| <b>PD-F0</b> | Felt pad feet        | + 6 €  | PD-F0  |

### Bolle D60

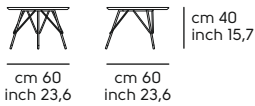

### Bolle Q100

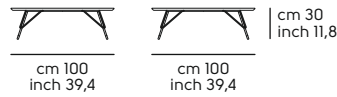

## Coffee Table BOLLE OUTDOOR

Frame in: INOX



| Version | Code | Mod. | Frame | Top | Optional | Q.ty | boxes | Kg | M <sup>2</sup> |
|---------|------|------|-------|-----|----------|------|-------|----|----------------|
|---------|------|------|-------|-----|----------|------|-------|----|----------------|

### Bolle HPL

Top 10 mm. thk

|                   |          |      |    | HH1   | HH2   | HH3   |       |   |   |      |      |
|-------------------|----------|------|----|-------|-------|-------|-------|---|---|------|------|
| BOLLE D. 60 OUT   | T2200D61 | D60  | M1 | 487 € | 508 € | 426 € | FM-M2 | 1 | 2 | 11   | 0.15 |
| BOLLE 100x100 OUT | T2200Q11 | Q100 | M1 | 700 € | 830 € | 952 € | FM-M2 | 1 | 2 | 20.5 | 0.33 |

| Version | Code | Mod. | Frame | Top | Optional | Q.ty | boxes | Kg | M <sup>2</sup> |
|---------|------|------|-------|-----|----------|------|-------|----|----------------|
|---------|------|------|-------|-----|----------|------|-------|----|----------------|

### Bolle Metal

Top 4 mm. thk

|                      |          |      |    | O1    | O2    |       |   |   |      |      |
|----------------------|----------|------|----|-------|-------|-------|---|---|------|------|
| BOLLE D. 60 MT OUT   | T2201D61 | D60  | M1 | 304 € | 328 € | FM-M2 | 1 | 2 | 14   | 0.15 |
| BOLLE 100x100 MT OUT | T2201Q11 | Q100 | M1 | 542 € | 573 € | FM-M2 | 1 | 2 | 30.5 | 0.33 |

| Version | Code | Mod. | Frame | Top | Optional | Q.ty | boxes | Kg | M <sup>2</sup> |
|---------|------|------|-------|-----|----------|------|-------|----|----------------|
|---------|------|------|-------|-----|----------|------|-------|----|----------------|

### Bolle Marble

Top 20 mm. thk

|                      |          |      |    | GMM     |       |   |   |      |      |
|----------------------|----------|------|----|---------|-------|---|---|------|------|
| BOLLE D. 60 MR OUT   | T2202D61 | D60  | M1 | 718 €   | FM-M2 | 1 | 2 | 20.5 | 0.15 |
| BOLLE 100x100 MR OUT | T2202Q11 | Q100 | M1 | 1.643 € | FM-M2 | 1 | 2 | 59.5 | 0.33 |

**Frame finishes**

**Metal**

|           |  |
|-----------|--|
| <b>M1</b> | WHITE <b>BB</b> , INDUSTRIAL <b>E5</b> , BROWN <b>E6</b> , SAND <b>EC</b> , WHITE PEARL <b>EF</b> , GRAPHITE <b>EG</b> , BLACK <b>EN</b> |
|-----------|--|

**Top finishes**

**HPL**

|            |   |
|------------|---|
| <b>HH1</b> | WHITE/Black Core <b>HB4</b> , BLACK/Black Core <b>HN4</b>   |
| <b>HH2</b> | CEMENT/Black Core <b>HC6</b> , CORTEN/Brown Core <b>HC7</b> , DARK GREY/Black Core <b>HGW</b>   |
| <b>HH3</b> | ST WHITE/White Core <b>AB4</b> , ST SAND/Sand Core <b>ACR</b> , ST GRAPHITE GREY/Gravite Core <b>AGD</b> , ST BLACK/Black Core <b>AN4</b> , ST TORTORA/Tortora Core <b>ATR</b> , ST RED NAMIB/Red Core <b>FAM</b> , ST YELLOW EVORA/Yellow Core <b>FGO</b> , ST RED BULGARO/Red Core <b>FRB</b> , ST GREEN KITAMI/Green Core <b>FVK</b> |

**Metal Outdoor**

|           |   |
|-----------|---|
| <b>O1</b> | Outdoor BROWN <b>E6</b> , Outdoor WHITE <b>BB</b> , Outdoor SAND <b>EC</b> , Outdoor WHITE PEARL <b>EF</b> , Outdoor GRAFITE <b>EG</b> , Outdoor BLACK <b>EN</b>  |
| <b>O2</b> | Outdoor LIGHT BLUE <b>E0</b> , Outdoor OCEAN BLUE <b>E1</b> , Outdoor FANGO <b>E3</b> , Outdoor PASTEL YELLOW <b>E4</b> , Outdoor OCHER YELLOW <b>E7</b> , Outdoor FACEPOWDER PINK <b>E8</b> , Outdoor SAGE GREEN <b>E9</b> , Outdoor BLUE SAPPHIRE <b>EE</b> , Outdoor BLUE TURQUOISE <b>EH</b> , Outdoor PINE GREEN <b>EJ</b> , Outdoor DARK GREEN <b>EL</b> , Outdoor GOLD YELLOW <b>EO</b> , Outdoor RED BULGARO <b>FP</b> , Outdoor CHERRY RED <b>EQ</b> , Outdoor RED <b>ER</b> , Outdoor ASH GREY <b>ES</b> , Outdoor LIGHT GREY <b>ET</b> , Outdoor PAPAYA ORANGE <b>EA</b> , Outdoor BRONZE <b>EZ</b> +TRANSP. |

**Marble**

|            |   |
|------------|---|
| <b>GMM</b> | BEIGE TRAVERTINO ROMANO <b>MB2</b> , WHITE CALACATTA VAGLI <b>MB4</b> , BLACK MARQUINIA <b>MN4</b> , GREEN TINOS <b>MVE</b> |
|------------|---|

**Optionals:**

|              |                      | Value  | Options/notes  |
|--------------|----------------------|--------|--|
| <b>FM-M2</b> | Indoor matt metal M2 | + 83 € | ASH GREY <b>ES</b> , BLUE SAPPHIRE <b>EE</b> , BLUE TURQUOISE <b>EH</b> , BRONZE <b>E2</b> , BULGARO RED <b>FP</b> , CHERRY RED <b>EQ</b> , DARK GREEN <b>EL</b> , FACEPOWDER PINK <b>E8</b> , FANGO <b>E3</b> , GOLDEN YELLOW <b>EO</b> , LIGHT BLUE <b>E0</b> , LIGHT GREY <b>ET</b> , OCEAN BLUE <b>E1</b> , OCHER YELLOW <b>E7</b> , PAPAYA ORANGE <b>EA</b> , PASTEL YELLOW <b>E4</b> , PINE GREEN <b>EJ</b> , RED <b>ER</b> , SAGE GREEN <b>E9</b> |

**Bolle D60**



**Bolle Q100**

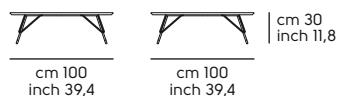

# Clessidra design Paolo Vernier

## Coffee Table CLESSIDRA

Frame in: metal



| Version | Code | Mod. | Frame | Top | Optional | Q.ty | boxes | Kg | M <sup>3</sup> |
|---------|------|------|-------|-----|----------|------|-------|----|----------------|
|---------|------|------|-------|-----|----------|------|-------|----|----------------|

### Clessidra MDF

Top 19 mm. thk

|                   |            |         |    | LM1   |       |   |   |      |      |
|-------------------|------------|---------|----|-------|-------|---|---|------|------|
| CLESSIDRA H26 D70 | TI9652770L | H26 D70 | M1 | 568 € | FM-M2 | 1 | 2 | 22.5 | 0.12 |
| CLESSIDRA H30 D80 | TI9653480L | H30 D80 | M1 | 652 € | FM-M2 | 1 | 2 | 30   | 0.15 |
| CLESSIDRA H40 D40 | TI9654040L | H40 D40 | M1 | 448 € | FM-M2 | 1 | 2 | 15.5 | 0.04 |
| CLESSIDRA H50 D50 | TI9655050L | H50 D50 | M1 | 475 € | FM-M2 | 1 | 2 | 18.5 | 0.06 |

| Version | Code | Mod. | Frame | Top | Optional | Q.ty | boxes | Kg | M <sup>3</sup> |
|---------|------|------|-------|-----|----------|------|-------|----|----------------|
|---------|------|------|-------|-----|----------|------|-------|----|----------------|

### Clessidra Metal

Top 3 mm. thk

|                   |            |         |    | M1    | M2    |       |   |   |    |      |
|-------------------|------------|---------|----|-------|-------|-------|---|---|----|------|
| CLESSIDRA H26 D70 | TI9652770M | H26 D70 | M1 | 560 € | 596 € | FM-M2 | 1 | 2 | 26 | 0.12 |
| CLESSIDRA H30 D80 | TI9653480M | H30 D80 | M1 | 612 € | 640 € | FM-M2 | 1 | 2 | 34 | 0.15 |
| CLESSIDRA H40 D40 | TI9654040M | H40 D40 | M1 | 441 € | 470 € | FM-M2 | 1 | 2 | 17 | 0.04 |
| CLESSIDRA H50 D50 | TI9655050M | H50 D50 | M1 | 455 € | 484 € | FM-M2 | 1 | 2 | 20 | 0.06 |

| Version | Code | Mod. | Frame | Top | Optional | Q.ty | boxes | Kg | M <sup>3</sup> |
|---------|------|------|-------|-----|----------|------|-------|----|----------------|
|---------|------|------|-------|-----|----------|------|-------|----|----------------|

### Clessidra Hide

Top 5 mm. thk

|                   |            |         |    | CU    | CT    |       |   |   |      |      |
|-------------------|------------|---------|----|-------|-------|-------|---|---|------|------|
| CLESSIDRA H26 D70 | TI9652770C | H26 D70 | M1 | 613 € | 642 € | FM-M2 | 1 | 2 | 28   | 0.12 |
| CLESSIDRA H30 D80 | TI9653480C | H30 D80 | M1 | 668 € | 707 € | FM-M2 | 1 | 2 | 36.5 | 0.15 |
| CLESSIDRA H40 D40 | TI9654040C | H40 D40 | M1 | 470 € | 491 € | FM-M2 | 1 | 2 | 18   | 0.04 |
| CLESSIDRA H50 D50 | TI9655050C | H50 D50 | M1 | 488 € | 520 € | FM-M2 | 1 | 2 | 21   | 0.06 |

| Version | Code | Mod. | Frame | Top | Optional | Q.ty | boxes | Kg | M <sup>3</sup> |
|---------|------|------|-------|-----|----------|------|-------|----|----------------|
|---------|------|------|-------|-----|----------|------|-------|----|----------------|

### Clessidra Ceramic

Top 6 mm. thk

|                   |            |            |    | GKA   | GKB   | GMA   |       |   |   |      |      |
|-------------------|------------|------------|----|-------|-------|-------|-------|---|---|------|------|
| CLESSIDRA H26 D70 | T19652770V | H26<br>D70 | M1 | 652 € | 682 € | 711 € | FM-M2 | 1 | 2 | 29   | 0.12 |
| CLESSIDRA H30 D80 | T19653480V | H30<br>D80 | M1 | 720 € | 740 € | 777 € | FM-M2 | 1 | 2 | 38   | 0.15 |
| CLESSIDRA H40 D40 | T19654040V | H40<br>D40 | M1 | 501 € | 518 € | 535 € | FM-M2 | 1 | 2 | 18   | 0.04 |
| CLESSIDRA H50 D50 | T19655050V | H50<br>D50 | M1 | 550 € | 568 € | 584 € | FM-M2 | 1 | 2 | 21.5 | 0.06 |

| Version | Code | Mod. | Frame | Top | Optional | Q.ty | boxes | Kg | M <sup>3</sup> |
|---------|------|------|-------|-----|----------|------|-------|----|----------------|
|---------|------|------|-------|-----|----------|------|-------|----|----------------|

### Clessidra Marble

Top 20 mm. thk

|                   |            |            |    | GMM     |  |       |   |   |    |      |
|-------------------|------------|------------|----|---------|--|-------|---|---|----|------|
| CLESSIDRA H26 D70 | T19652770Z | H26<br>D70 | M1 | 1.060 € |  | FM-M2 | 1 | 2 | 36 | 0.12 |
| CLESSIDRA H30 D80 | T19653480Z | H30<br>D80 | M1 | 1.267 € |  | FM-M2 | 1 | 2 | 48 | 0.15 |
| CLESSIDRA H40 D40 | T19654040Z | H40<br>D40 | M1 | 850 €   |  | FM-M2 | 1 | 2 | 20 | 0.04 |
| CLESSIDRA H50 D50 | T19655050Z | H50<br>D50 | M1 | 990 €   |  | FM-M2 | 1 | 2 | 34 | 0.06 |

## Frame and Top finishes

### Metal

|           |  |           |  |
|-----------|--|-----------|--|
| <b>M1</b> | WHITE <b>BB</b> , INDUSTRIAL <b>E5</b> , BROWN <b>E6</b> , SAND <b>EC</b> , WHITE PEARL <b>EF</b> , GRAPHITE <b>EG</b> , BLACK <b>EN</b> | <b>M2</b> | LIGHT BLUE <b>E0</b> , OCEAN BLUE <b>E1</b> , BRONZE <b>E2</b> , FANGO <b>E3</b> , PASTEL YELLOW <b>E4</b> , OCHER YELLOW <b>E7</b> , FACEPOWDER PINK <b>E8</b> , SAGE GREEN <b>E9</b> , PAPAYA ORANGE <b>EA</b> , BLUE SAPPHIRE <b>EE</b> , BLUE TURQUOISE <b>EH</b> , PINE GREEN <b>EJ</b> , DARK GREEN <b>EL</b> , GOLDEN YELLOW <b>EO</b> , CHERRY RED <b>EQ</b> , RED <b>ER</b> , ASH GREY <b>ES</b> , LIGHT GREY <b>ET</b> , BULGARO RED <b>FP</b> |
|-----------|--|-----------|--|

### Insert finishes

### Metal

|           |  |
|-----------|--|
| <b>M1</b> | WHITE <b>BB</b> , INDUSTRIAL <b>E5</b> , BROWN <b>E6</b> , SAND <b>EC</b> , WHITE PEARL <b>EF</b> , GRAPHITE <b>EG</b> , BLACK <b>EN</b>   |
| <b>M2</b> | LIGHT BLUE <b>E0</b> , OCEAN BLUE <b>E1</b> , BRONZE <b>E2</b> , FANGO <b>E3</b> , PASTEL YELLOW <b>E4</b> , OCHER YELLOW <b>E7</b> , FACEPOWDER PINK <b>E8</b> , SAGE GREEN <b>E9</b> , PAPAYA ORANGE <b>EA</b> , BLUE SAPPHIRE <b>EE</b> , BLUE TURQUOISE <b>EH</b> , PINE GREEN <b>EJ</b> , DARK GREEN <b>EL</b> , GOLDEN YELLOW <b>EO</b> , CHERRY RED <b>EQ</b> , RED <b>ER</b> , ASH GREY <b>ES</b> , LIGHT GREY <b>ET</b> , BULGARO RED <b>FP</b> |
| <b>M4</b> | GOLDEN BRONZE <b>DB</b> , MATT GOLDEN BRONZE <b>DC</b> , CHAMPAGNE GOLD <b>DG</b> , PINK GOLD <b>DR</b> , MATT BLACK NICKEL <b>DY</b> , BLACK NICKEL <b>DZ</b>   |

### Top finishes

#### Lacquered MDF

|            |   |
|------------|---|
| <b>LMI</b> | GRAPHITE GREY <b>G02</b> , BLACK <b>G04</b> , WHITE <b>G05</b> , SAND <b>G07</b> , BROWN <b>G41</b> |
|------------|---|

#### Hide

|           |             |
|-----------|-------------|
| <b>CU</b> | HIDE        |
| <b>CT</b> | TUSCAN HIDE |

#### Crystal Ceramic and Ceramic

|            |   |
|------------|---|
| <b>GKA</b> | CHARCOAL SAVOIA <b>K11</b> , CEMENT SAVOIA <b>K12</b>   |
| <b>GKB</b> | WHITE CALCE <b>K24</b> , BLACK CALCE <b>K25</b> , TORTORA CALCE <b>K26</b> , PIASENTINA STONE TAUPE Materica <b>K55</b> , TERRACOTTA Matt <b>K90</b> , MATT GREEN <b>K91</b>  |
| <b>GMA</b> | MARBLE CALACATTA GLOSSY WHITE <b>K32</b> , BLACK GREEK MARBLE <b>K33</b> , MARBLE GLOSSY NOIR DESIR <b>K35</b> , MARBLE CALACATTA MATT WHITE <b>K42</b> , MARBLE MATT NOIR DESIR <b>K45</b> , MARBLE MATT GREEN TINOS <b>K46</b> , MARBLE STATUARIO WHITE MATT <b>K47</b> , MARBLE CALACAT BLACK Bush Hammered <b>K50</b> |

#### Marble

|            |   |
|------------|---|
| <b>GMM</b> | BEIGE TRAVERTINO ROMANO <b>MB2</b> , WHITE CALACATTA VAGLI <b>MB4</b> , BLACK MARQUINIA <b>MN4</b> , GREEN TINOS <b>MVE</b> |
|------------|---|

### Optionals:

|              |                      | Value  | Options/notes  |
|--------------|----------------------|--------|--|
| <b>FM-M2</b> | Indoor matt metal M2 | + 99 € | ASH GREY <b>ES</b> , BLUE SAPPHIRE <b>EE</b> , BLUE TURQUOISE <b>EH</b> , BRONZE <b>E2</b> , BULGARO RED <b>FP</b> , CHERRY RED <b>EQ</b> , DARK GREEN <b>EL</b> , FACEPOWDER PINK <b>E8</b> , FANGO <b>E3</b> , GOLDEN YELLOW <b>EO</b> , LIGHT BLUE <b>E0</b> , LIGHT GREY <b>ET</b> , OCEAN BLUE <b>E1</b> , OCHER YELLOW <b>E7</b> , PAPAYA ORANGE <b>EA</b> , PASTEL YELLOW <b>E4</b> , PINE GREEN <b>EJ</b> , RED <b>ER</b> , SAGE GREEN <b>E9</b> |

#### Clessidra H26 D70

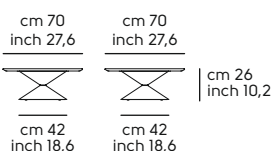

#### Clessidra H30 D80

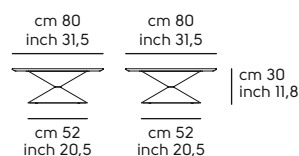

#### Clessidra H40 D40

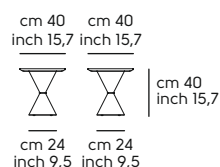

#### Clessidra H50 D50

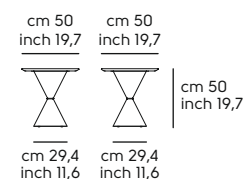

# Dalia design Beatriz Sempere

## Coffee Table DALIA

Frame in: wood



| Version                               | Code     | Mod. | Frame   | Top   | Optional | Q.ty  | boxes | Kg | M <sup>3</sup> |       |
|---------------------------------------|----------|------|---------|-------|----------|-------|-------|----|----------------|-------|
| <b>Dalia Veneer</b><br>Top 17 mm. thk |          |      |         |       |          |       |       |    |                |       |
|                                       |          |      |         | L11   | L12      |       |       |    |                |       |
| DALIA CTS_H45                         | T1850H45 | CTS  | L11-L12 | 420 € | 458 €    | PD-F0 | 1     | 1  | 3.6            | 0.087 |
| DALIA CTM_H40                         | T1850H40 | CTM  | L11-L12 | 524 € | 563 €    | PD-F0 | 1     | 1  | 4.45           | 0.12  |
| DALIA CTL_H35                         | T1850H35 | CTL  | L11-L12 | 751 € | 808 €    | PD-F0 | 1     | 1  | 9.55           | 0.25  |

### Note:

--

### Frame finishes

#### Veneer

|            |  |
|------------|--|
| <b>L11</b> | Veneered wood painted BLACK <b>I04</b> , Veneered wood painted NATURAL <b>I40</b> , Veneered wood painted WHITENED <b>I60</b> , Veneered wood painted DESERT <b>I61</b> , Veneered wood painted LIGHT GREY <b>I62</b> , Veneered wood painted DARK GREY <b>I63</b> |
| <b>L12</b> | Veneered wood NATURAL OAK <b>I22</b> , Veneered wood FLAMED WALNUT <b>I24</b>  |

### Top finishes

#### Wood

|            |  |
|------------|--|
| <b>L11</b> | Stained BLACK <b>I04</b> , Stained NATURAL <b>I40</b> , Stained WHITENED <b>I60</b> , Stained DESERT <b>I61</b> , Stained LIGHT GREY <b>I62</b> , Stained DARK GREY <b>I63</b> |
| <b>L12</b> | NATURAL OAK <b>I22</b> , FLAMED WALNUT <b>I24</b>  |

### Optionals:

|              | Value         | Options/notes |
|--------------|---------------|---------------|
| <b>PD-F0</b> | Felt pad feet | + 6 € PD-F0   |

#### Dalia CTS

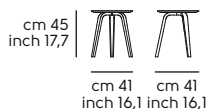

#### Dalia CTM

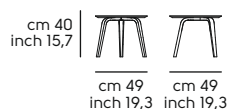

#### Dalia CTL

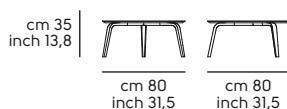

# Drop design Gabriele Panciera

## Coffee Table DROP

Frame in: metal with feets or wheels



| Version | Code | Mod. | Frame | Top | Optional | Q.ty | boxes | Kg | M <sup>3</sup> |
|---------|------|------|-------|-----|----------|------|-------|----|----------------|
|---------|------|------|-------|-----|----------|------|-------|----|----------------|

### Drop Veneer - with feets or wheels

Top 18 mm. thk

|              |             |            |    | L11   | L12   |       |   |   |    |      |
|--------------|-------------|------------|----|-------|-------|-------|---|---|----|------|
| DROP D35 H35 | T24003535LG | D35<br>H35 | M1 | 581 € | 592 € | FM-M2 | 1 | 1 | 12 | 0.06 |
| DROP D35 H45 | T24003545LG | D35<br>H45 | M1 | 592 € | 602 € | FM-M2 | 1 | 1 | 13 | 0.07 |
| DROP D35 H55 | T24003555LG | D35<br>H55 | M1 | 602 € | 612 € | FM-M2 | 1 | 1 | 14 | 0.09 |
| DROP D65 H35 | T24006535LG | D65<br>H35 | M1 | 847 € | 867 € | FM-M2 | 1 | 1 | 25 | 0.19 |
| DROP D65 H45 | T24006545LG | D65<br>H45 | M1 | 867 € | 887 € | FM-M2 | 1 | 1 | 28 | 0.24 |

| Version | Code | Mod. | Frame | Top | Optional | Q.ty | boxes | Kg | M <sup>3</sup> |
|---------|------|------|-------|-----|----------|------|-------|----|----------------|
|---------|------|------|-------|-----|----------|------|-------|----|----------------|

### Drop Metal - with feets or wheels

Top 13 mm. thk

|              |             |            |    | M1    | M2    |       |   |   |    |      |
|--------------|-------------|------------|----|-------|-------|-------|---|---|----|------|
| DROP D35 H35 | T24003535MT | D35<br>H35 | M1 | 502 € | 553 € | FM-M2 | 1 | 1 | 12 | 0.06 |
| DROP D35 H45 | T24003545MT | D35<br>H45 | M1 | 515 € | 566 € | FM-M2 | 1 | 1 | 13 | 0.07 |
| DROP D35 H55 | T24003555MT | D35<br>H55 | M1 | 525 € | 576 € | FM-M2 | 1 | 1 | 14 | 0.09 |
| DROP D65 H35 | T24006535MT | D65<br>H35 | M1 | 694 € | 791 € | FM-M2 | 1 | 1 | 25 | 0.19 |
| DROP D65 H45 | T24006545MT | D65<br>H45 | M1 | 714 € | 811 € | FM-M2 | 1 | 1 | 28 | 0.24 |

| Version | Code | Mod. | Frame | Top | Optional | Q.ty | boxes | Kg | M <sup>3</sup> |
|---------|------|------|-------|-----|----------|------|-------|----|----------------|
|---------|------|------|-------|-----|----------|------|-------|----|----------------|

### Drop Hide - with feets or wheels

Top 16 mm. thk

|              |             |            |    | CU    | CT      |       |   |   |    |      |
|--------------|-------------|------------|----|-------|---------|-------|---|---|----|------|
| DROP D35 H35 | T24003535CU | D35<br>H35 | M1 | 612 € | 694 €   | FM-M2 | 1 | 1 | 12 | 0.06 |
| DROP D35 H45 | T24003545CU | D35<br>H45 | M1 | 622 € | 704 €   | FM-M2 | 1 | 1 | 13 | 0.07 |
| DROP D35 H55 | T24003555CU | D35<br>H55 | M1 | 632 € | 714 €   | FM-M2 | 1 | 1 | 14 | 0.09 |
| DROP D65 H35 | T24006535CU | D65<br>H35 | M1 | 906 € | 1.000 € | FM-M2 | 1 | 1 | 25 | 0.19 |
| DROP D65 H45 | T24006545CU | D65<br>H45 | M1 | 926 € | 1.020 € | FM-M2 | 1 | 1 | 28 | 0.24 |

| Version | Code | Mod. | Frame | Top |  |  |  |  |  |  |  |  | Optional | Q.ty | boxes | Kg | M <sup>3</sup> |
|---------|------|------|-------|-----|--|--|--|--|--|--|--|--|----------|------|-------|----|----------------|
|---------|------|------|-------|-----|--|--|--|--|--|--|--|--|----------|------|-------|----|----------------|

**Drop Fabric - with feet or wheels**

Top 40 mm. thk

|              |             |         |    | TA    | TB    | TC    | TD    | TE      | SF    | SV    | COM   | COL   |            |   |   |    |      |
|--------------|-------------|---------|----|-------|-------|-------|-------|---------|-------|-------|-------|-------|------------|---|---|----|------|
| DROP D35 H35 | T24003535TS | D35 H35 | MI | 592 € | 595 € | 601 € | 606 € | 634 €   | 604 € | 613 € | 592 € | 601 € | FM-M2 ES-1 | 1 | 1 | 12 | 0.06 |
| DROP D35 H45 | T24003545TS | D35 H45 | MI | 602 € | 605 € | 611 € | 616 € | 645 €   | 614 € | 623 € | 602 € | 611 € | FM-M2 ES-1 | 1 | 1 | 13 | 0.08 |
| DROP D35 H55 | T24003555TS | D35 H55 | MI | 612 € | 615 € | 621 € | 626 € | 655 €   | 624 € | 633 € | 612 € | 621 € | FM-M2 ES-1 | 1 | 1 | 14 | 0.09 |
| DROP D65 H35 | T24006535TS | D65 H35 | MI | 894 € | 904 € | 919 € | 932 € | 1.011 € | 927 € | 952 € | 894 € | 919 € | FM-M2 ES-1 | 1 | 1 | 25 | 0.20 |
| DROP D65 H45 | T24006545TS | D65 H45 | MI | 914 € | 924 € | 939 € | 953 € | 1.031 € | 948 € | 972 € | 914 € | 939 € | FM-M2 ES-1 | 1 | 1 | 28 | 0.26 |



| Version | Code | Mod. | Frame | Top |  |  |  |  |  |  |  |  | Optional | Q.ty | boxes | Kg | M <sup>3</sup> |
|---------|------|------|-------|-----|--|--|--|--|--|--|--|--|----------|------|-------|----|----------------|
|---------|------|------|-------|-----|--|--|--|--|--|--|--|--|----------|------|-------|----|----------------|

**Drop Ceramic - with feet or wheels**



Top 15/18 mm thk

|              |             |         |    | GKA     | GKB     | GMA     |       |   |   |    |      |
|--------------|-------------|---------|----|---------|---------|---------|-------|---|---|----|------|
| DROP D35 H35 | T24003535KR | D35 H35 | MI | 661 €   | 668 €   | 673 €   | FM-M2 | 1 | 1 | 12 | 0.06 |
| DROP D35 H45 | T24003545KR | D35 H45 | MI | 671 €   | 678 €   | 683 €   | FM-M2 | 1 | 1 | 13 | 0.07 |
| DROP D35 H55 | T24003555KR | D35 H55 | MI | 681 €   | 689 €   | 694 €   | FM-M2 | 1 | 1 | 14 | 0.09 |
| DROP D65 H35 | T24006535KR | D65 H35 | MI | 1.044 € | 1.060 € | 1.075 € | FM-M2 | 1 | 1 | 25 | 0.19 |
| DROP D65 H45 | T24006545KR | D65 H45 | MI | 1.065 € | 1.080 € | 1.095 € | FM-M2 | 1 | 1 | 28 | 0.24 |

**COM/COL - Minimum Q.ty 5 pc. for each material. For weft or patterned fabrics see specific pages**

|   |                              |  |                     |
|---|------------------------------|--|---------------------|
|  <b>COM</b> | D.35: Mtl. 0.25 h. 1.40 Each |  <b>COL</b> | D.35: Mq. 0.34 Each |
|---|------------------------------|--|---------------------|

**COM/COL - Minimum Q.ty 5 pc. for each material. For weft or patterned fabrics see specific pages**

|   |                              |  |                     |
|---|------------------------------|--|---------------------|
|  <b>COM</b> | D.65: Mtl. 0.60 h. 1.40 Each |  <b>COL</b> | D.65: Mq. 0.87 Each |
|---|------------------------------|--|---------------------|

q

**Frame and Top finishes****Metal**

|           |   |           |  |
|-----------|---|-----------|--|
| <b>MI</b> | WHITE <b>BB</b> , BROWN <b>E6</b> , SAND <b>EC</b> , WHITE PEARL <b>EF</b> , GRAPHITE <b>EG</b> , BLACK <b>EN</b> | <b>M2</b> | LIGHT BLUE <b>E0</b> , OCEAN BLUE <b>E1</b> , BRONZE <b>E2</b> , FANGO <b>E3</b> , PASTEL YELLOW <b>E4</b> , OCHER YELLOW <b>E7</b> , FACEPOWDER PINK <b>E8</b> , SAGE GREEN <b>E9</b> , PAPAYA ORANGE <b>EA</b> , BLUE SAPPHIRE <b>EE</b> , BLUE TURQUOISE <b>EH</b> , PINE GREEN <b>EJ</b> , DARK GREEN <b>EL</b> , GOLDEN YELLOW <b>EO</b> , CHERRY RED <b>EQ</b> , RED <b>ER</b> , ASH GREY <b>ES</b> , LIGHT GREY <b>ET</b> , BRONZE <b>EZ</b> + TRANSP., BULGARO RED <b>FP</b> |
|-----------|---|-----------|--|

## Top finishes

### Wood

|            |  |
|------------|--|
| <b>L11</b> | Stained BLACK <b>I04</b> , Stained WHITE <b>I05</b> , Stained CHERRY RED <b>I09</b> , Stained DARK BROWN <b>I26</b> , Stained NATURAL <b>I40</b> , Stained NATURAL OAK <b>I52</b> , Stained WHITENED <b>I60</b> , Stained DESERT <b>I61</b> , Stained LIGHT GREY <b>I62</b> , Stained DARK GREY <b>I63</b> |
| <b>L12</b> | FLAMED WALNUT <b>I24</b>   |

### Ceramic

|            |   |
|------------|---|
| <b>GKA</b> | CHARCOAL SAVOIA <b>K11</b> , CEMENT SAVOIA <b>K12</b>   |
| <b>GKB</b> | WHITE CALCE <b>K24</b> , BLACK CALCE <b>K25</b> , TORTORA CALCE <b>K26</b> , PIASENTINA STONE TAUPE Materica <b>K55</b> , TERRACOTTA Matt <b>K90</b> , MATT GREEN <b>K91</b>  |
| <b>GMA</b> | MARBLE CALACATTA GLOSSY WHITE <b>K32</b> , BLACK GREEK MARBLE <b>K33</b> , MARBLE GLOSSY NOIR DESIR <b>K35</b> , MARBLE CALACATTA MATT WHITE <b>K42</b> , MARBLE MATT NOIR DESIR <b>K45</b> , MARBLE MATT GREEN TINOS <b>K46</b> , MARBLE STATUARIO WHITE MATT <b>K47</b> , MARBLE CALACAT BLACK Bush Hammered <b>K50</b> |

## Top finishes

### Upholstery

|           |   |           |  |
|-----------|---|-----------|--|
| <b>TA</b> | FAUX LEATHER <b>Secret</b> , FABRIC <b>Mirage</b> , FABRIC <b>Cotton Club</b> , FABRIC <b>Renewed Loop</b>  | <b>TB</b> | FAUX LEATHER <b>Vintage</b> , FABRIC <b>Fenix Wool</b> , FABRIC <b>Visual</b> , FABRIC <b>Manhattan</b> , FABRIC <b>Novabuk</b> , FABRIC <b>Network</b> , FABRIC <b>Gyre</b> |
| <b>TC</b> | VELVET SUPERB, FABRIC <b>Second</b> , FABRIC <b>Main Line Flax</b> , FABRIC <b>Oceanic</b> , FABRIC <b>Jumper</b> , FABRIC <b>Flame</b> , FABRIC <b>Ouche</b> , FABRIC <b>Plain</b> , FABRIC <b>Gemma</b> , FABRIC <b>Caltagirone 114</b> | <b>TD</b> | FABRIC <b>Yoredale</b> , FABRIC <b>Remix 3</b>   |
| <b>TE</b> | FABRIC <b>Uniform Melange</b>   | <b>SF</b> | LEATHER <b>Fiore</b>   |
| <b>SV</b> | LEATHER <b>Vintage</b>  |           |  |

## Top finishes

### Hide

|           |             |
|-----------|-------------|
| <b>CU</b> | HIDE        |
| <b>CT</b> | TUSCAN HIDE |

## Optionals:

|              |                      | Value  | Options/notes  |
|--------------|----------------------|--------|--|
| <b>FM-M2</b> | Indoor matt metal M2 | + 71 € | ASH GREY <b>ES</b> , BLUE SAPPHIRE <b>EE</b> , BLUE TURQUOISE <b>EH</b> , BRONZE <b>E2</b> , BRONZE <b>EZ</b> + TRANSP., BULGARO RED <b>FP</b> , CHERRY RED <b>EQ</b> , DARK GREEN <b>EL</b> , FACEPOWDER PINK <b>E8</b> , FANGO <b>E3</b> , GOLDEN YELLOW <b>EO</b> , LIGHT BLUE <b>EO</b> , LIGHT GREY <b>ET</b> , OCEAN BLUE <b>E1</b> , OCHER YELLOW <b>E7</b> , PAPAYA ORANGE <b>EA</b> , PASTEL YELLOW <b>E4</b> , PINE GREEN <b>EJ</b> , RED <b>ER</b> , SAGE GREEN <b>E9</b> |
| <b>ES-1</b>  | Fireproof foam       | + 10 € | ES-1   |

### Drop D35 H35

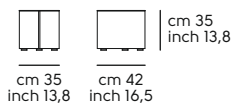

### Drop D35 H45

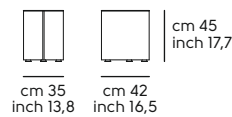

### Drop D35 H55

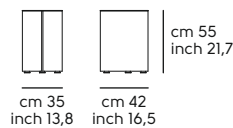

### Drop D65 H35

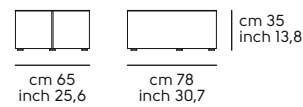

### Drop D65 H45

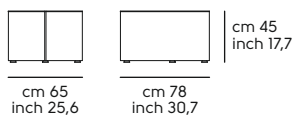

### Drop D35 H35 TS

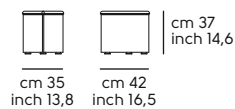

### Drop D35 H45 TS

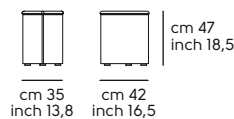

### Drop D35 H55 TS

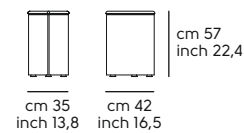

### Drop D65 H35 TS

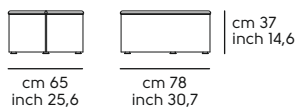

### Drop D65 H45 TS

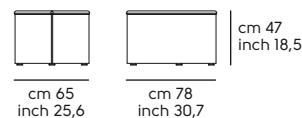

# Guapa design Sempere e Poli

## Coffee Table GUAPA

Frame in: metal



| Version                             | Code     | Mod. | Frame | Top   | Optional | Q.ty                    | boxes | Kg | M <sup>3</sup> |      |
|-------------------------------------|----------|------|-------|-------|----------|-------------------------|-------|----|----------------|------|
| <b>Guapa Hide</b><br>Top 18 mm. thk |          |      |       |       |          |                         |       |    |                |      |
|                                     |          |      |       | CU    | CT       |                         |       |    |                |      |
| GUAPA CT-S                          | TI150CTS | CTS  | MI    | 319 € | 362 €    | FM-M2<br>FM-M3<br>FM-M4 | 1     | 2  | 5              | 0.12 |
| GUAPA CT-M                          | TI150CTM | CTM  | MI    | 412 € | 495 €    | FM-M2<br>FM-M3<br>FM-M4 | 1     | 2  | 8.1            | 0.20 |
| GUAPA CT-L                          | TI150CTL | CTL  | MI    | 746 € | 943 €    | FM-M2<br>FM-M3<br>FM-M4 | 1     | 2  | 16             | 0.45 |

### Frame finishes

#### Metal

**MI** WHITE **BB**, BROWN **E6**, SAND **EC**, WHITE PEARL **EF**, GRAPHITE **EG**, BLACK **EN**

### Top finishes

#### Hide

**CU** HIDE

**CT** TUSCAN HIDE

### Optionals:

|              |                        | Value   | Options/notes  |
|--------------|------------------------|---------|--|
| <b>FM-M2</b> | Indoor matt metal M2   | + 54 €  | ASH GREY <b>ES</b> , BLUE SAPPHIRE <b>EE</b> , BLUE TURQUOISE <b>EH</b> , BRONZE <b>E2</b> , BULGARO RED <b>FP</b> , CHERRY RED <b>EQ</b> , DARK GREEN <b>EL</b> , FACEPOWDER PINK <b>E8</b> , FANGO <b>E3</b> , GOLDEN YELLOW <b>EO</b> , LIGHT BLUE <b>EO</b> , LIGHT GREY <b>ET</b> , OCEAN BLUE <b>E1</b> , OCHER YELLOW <b>E7</b> , PAPAYA ORANGE <b>EA</b> , PASTEL YELLOW <b>E4</b> , PINE GREEN <b>EJ</b> , RED <b>ER</b> , SAGE GREEN <b>E9</b> |
| <b>FM-M3</b> | Indoor glossy metal M3 | + 26 €  | CHROME <b>CC</b>   |
| <b>FM-M4</b> | Indoor glossy Metal M4 | + 108 € | BLACK NICKEL <b>DZ</b> , CHAMPAGNE GOLD <b>DG</b> , GOLDEN BRONZE <b>DB</b> , MATT BLACK NICKEL <b>DY</b> , MATT GOLDEN BRONZE <b>DC</b> , PINK GOLD <b>DR</b>   |

### Guapa CTS

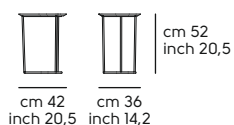

### Guapa CTM

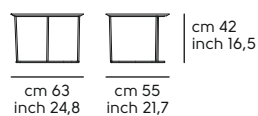

### Guapa CTL

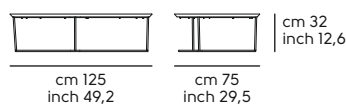

# Hoodi design Roberto Paoli

## Coffee Table HOODI

Frame in: metal



| Version                             | Code     | Mod. | -- | Frame and Top | Optional | Q.ty | boxes | Kg | M <sup>3</sup> |      |
|-------------------------------------|----------|------|----|---------------|----------|------|-------|----|----------------|------|
| <b>Hoodi Metal</b><br>Top 4 mm. thk |          |      |    |               |          |      |       |    |                |      |
|                                     |          |      |    | M1            | M2       |      |       |    |                |      |
| HOODI CTS_MT                        | T2060CTS | CTS  |    | 162 €         | 214 €    |      | 1     | 1  | 7              | 0.08 |
| HOODI CTM_MT                        | T2060CTM | CTM  |    | 180 €         | 233 €    |      | 1     | 1  | 7.5            | 0.11 |
| HOODI CTL_MT                        | T2060CTL | CTL  |    | 203 €         | 254 €    |      | 1     | 1  | 8              | 0.15 |

| Version                            | Code     | Mod. | Frame | Top   | Optional | Q.ty           | boxes | Kg | M <sup>3</sup> |      |
|------------------------------------|----------|------|-------|-------|----------|----------------|-------|----|----------------|------|
| <b>Hoodi Hide</b><br>Top 7 mm. thk |          |      |       |       |          |                |       |    |                |      |
|                                    |          |      |       | CU    | CT       |                |       |    |                |      |
| HOODI CTS_CU                       | T2062CTS | CTS  | M1    | 214 € | 254 €    | FM-M2<br>FM-M4 | 1     | 1  | 7.5            | 0.08 |
| HOODI CTM_CU                       | T2062CTM | CTM  | M1    | 249 € | 312 €    | FM-M2<br>FM-M4 | 1     | 1  | 8              | 0.11 |
| HOODI CTL_CU                       | T2062CTL | CTL  | M1    | 287 € | 389 €    | FM-M2<br>FM-M4 | 1     | 1  | 9              | 0.15 |

### Frame and Top finishes

#### Metal

|           |   |           |  |
|-----------|---|-----------|--|
| <b>M1</b> | WHITE <b>BB</b> , BROWN <b>E6</b> , SAND <b>EC</b> , WHITE PEARL <b>EF</b> , GRAPHITE <b>EG</b> , BLACK <b>EN</b> | <b>M2</b> | LIGHT BLUE <b>E0</b> , OCEAN BLUE <b>E1</b> , BRONZE <b>E2</b> , FANGO <b>E3</b> , PASTEL YELLOW <b>E4</b> , OCHER YELLOW <b>E7</b> , FACEPOWDER PINK <b>E8</b> , SAGE GREEN <b>E9</b> , PAPAYA ORANGE <b>EA</b> , BLUE SAPPHIRE <b>EE</b> , BLUE TURQUOISE <b>EH</b> , PINE GREEN <b>EJ</b> , DARK GREEN <b>EL</b> , GOLDEN YELLOW <b>EO</b> , CHERRY RED <b>EQ</b> , RED <b>ER</b> , ASH GREY <b>ES</b> , LIGHT GREY <b>ET</b> , BRONZE <b>EZ</b> + TRANSP., BULGARO RED <b>FP</b> |
|-----------|---|-----------|--|

### Top finishes

#### Hide

|           |      |           |             |
|-----------|------|-----------|-------------|
| <b>CU</b> | HIDE | <b>CT</b> | TUSCAN HIDE |
|-----------|------|-----------|-------------|

### Optionals:

|              | Value   | Options/notes  |
|--------------|---------|--|
| <b>FM-M2</b> | + 60 €  | ASH GREY <b>ES</b> , BLUE SAPPHIRE <b>EE</b> , BLUE TURQUOISE <b>EH</b> , BRONZE <b>E2</b> , BULGARO RED <b>FP</b> , CHERRY RED <b>EQ</b> , DARK GREEN <b>EL</b> , FACEPOWDER PINK <b>E8</b> , FANGO <b>E3</b> , GOLDEN YELLOW <b>EO</b> , LIGHT BLUE <b>E0</b> , LIGHT GREY <b>ET</b> , OCEAN BLUE <b>E1</b> , OCHER YELLOW <b>E7</b> , PAPAYA ORANGE <b>EA</b> , PASTEL YELLOW <b>E4</b> , PINE GREEN <b>EJ</b> , RED <b>ER</b> , SAGE GREEN <b>E9</b> |
| <b>FM-M4</b> | + 128 € | BLACK NICKEL <b>DZ</b> , CHAMPAGNE GOLD <b>DG</b> , GOLDEN BRONZE <b>DB</b> , MATT BLACK NICKEL <b>DY</b> , MATT GOLDEN BRONZE <b>DC</b> , PINK GOLD <b>DR</b>   |

#### Hoodi CTS

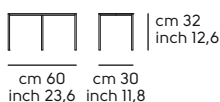

#### Hoodi CTM

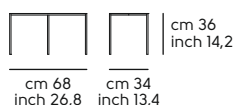

#### Hoodi CTL

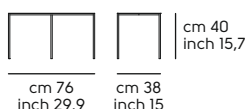

# Joint design Officina delle Idee

## Coffee Table JOINT

Frame in: metal



| Version            | Code     | Mod.  | Frame | Top     | Optional | Q.ty                    | boxes | Kg | M <sup>3</sup> |      |
|--------------------|----------|-------|-------|---------|----------|-------------------------|-------|----|----------------|------|
| <b>Joint Hide</b>  |          |       |       |         |          |                         |       |    |                |      |
| Top 30 mm. thk     |          |       |       |         |          |                         |       |    |                |      |
|                    |          |       |       | CU      | CT       |                         |       |    |                |      |
| JOINT H35 D. 50_CU | T0200C35 | H35_5 | MI    | 601 €   | 690 €    | FM-M2<br>FM-M3<br>FM-M4 | 1     | 1  | 9              | 0.12 |
| JOINT H60 D. 50_CU | T0200C60 | H60_5 | MI    | 626 €   | 714 €    | FM-M2<br>FM-M3<br>FM-M4 | 1     | 1  | 10             | 0.19 |
| JOINT H35 D.100_CU | T0200CA1 | H3510 | MI    | 1.009 € | 1.137 €  | FM-M2<br>FM-M3<br>FM-M4 | 1     | 1  | 16             | 0.21 |

## Joint Ceramic

Top 30 mm. thk

|                    |          |       |    |         |         |         |                         |   |   |    |      |
|--------------------|----------|-------|----|---------|---------|---------|-------------------------|---|---|----|------|
|                    |          |       |    | GKA     | GKB     | GMA     |                         |   |   |    |      |
| JOINT H35 D. 50_KR | T0200H35 | H35_5 | MI | 631 €   | 662 €   | 761 €   | FM-M2<br>FM-M3<br>FM-M4 | 1 | 1 | 9  | 0.12 |
| JOINT H60 D. 50_KR | T0200H60 | H60_5 | MI | 638 €   | 671 €   | 771 €   | FM-M2<br>FM-M3<br>FM-M4 | 1 | 1 | 10 | 0.19 |
| JOINT H35 D.100_KR | T0200HA1 | H3510 | MI | 1.041 € | 1.072 € | 1.122 € | FM-M2<br>FM-M3<br>FM-M4 | 1 | 1 | 16 | 0.21 |

### Note:

Top D.100 Ceramic K26 NOT available

## Frame finishes

### Metal

**MI** WHITE **BB**, BROWN **E6**, SAND **EC**, WHITE PEARL **EF**, GRAPHITE **EG**, BLACK **EN**

## Top finishes

### Hide

**CU** HIDE

**CT** TUSCAN HIDE

### Crystal Ceramic and Ceramic

**GKA** CHARCOAL SAVOIA **K11**, CEMENT SAVOIA **K12**

**GKB** WHITE CALCE **K24**, BLACK CALCE **K25**, TORTORA CALCE **K26**, PIASENTINA STONE TAUPE Materica **K55**, TERRACOTTA Matt **K90**, MATT GREEN **K91**

### Crystal Ceramic and Ceramic

**GMA** MARBLE CALACATTA GLOSSY WHITE **K32**, BLACK GREEK MARBLE **K33**, MARBLE GLOSSY NOIR DESIR **K35**, MARBLE CALACATTA MATT WHITE **K42**, MARBLE MATT NOIR DESIR **K45**, MARBLE MATT GREEN TINOS **K46**, MARBLE STATUARIO WHITE MATT **K47**, MARBLE CALACAT BLACK Bush Hammered **K50**

### Optionals:

|              |                        | Value   | Options/notes  |
|--------------|------------------------|---------|--|
| <b>FM-M2</b> | Indoor matt metal M2   | + 87 €  | ASH GREY <b>ES</b> , BLUE SAPPHIRE <b>EE</b> , BLUE TURQUOISE <b>EH</b> , BRONZE <b>E2</b> , BULGARO RED <b>FP</b> , CHERRY RED <b>EQ</b> , DARK GREEN <b>EL</b> , FACEPOWDER PINK <b>E8</b> , FANGO <b>E3</b> , GOLDEN YELLOW <b>EO</b> , LIGHT BLUE <b>EO</b> , LIGHT GREY <b>ET</b> , OCEAN BLUE <b>E1</b> , OCHER YELLOW <b>E7</b> , PAPAYA ORANGE <b>EA</b> , PASTEL YELLOW <b>E4</b> , PINE GREEN <b>EJ</b> , RED <b>ER</b> , SAGE GREEN <b>E9</b> |
| <b>FM-M3</b> | Indoor glossy metal M3 | + 66 €  | CHROME <b>CC</b>   |
| <b>FM-M4</b> | Indoor glossy Metal M4 | + 104 € | BLACK NICKEL <b>DZ</b> , CHAMPAGNE GOLD <b>DG</b> , GOLDEN BRONZE <b>DB</b> , MATT BLACK NICKEL <b>DY</b> , MATT GOLDEN BRONZE <b>DC</b> , PINK GOLD <b>DR</b>   |

### Joint H35\_5

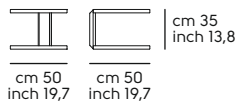

### Joint H60\_5

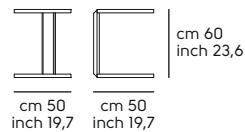

### Joint H35\_10

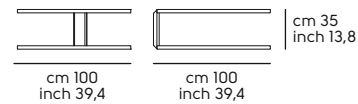

# Lea design Paolo Vernier

## Coffee Table LEA

Frame in: metal



| Version | Code | Mod. | Frame | Top | Optional | Q.ty | boxes | Kg | M <sup>3</sup> |
|---------|------|------|-------|-----|----------|------|-------|----|----------------|
|---------|------|------|-------|-----|----------|------|-------|----|----------------|

### Lea Veneer

Top 16 mm. thk

|             |          |     |    | LI1   | LI2   |                         |   |   |      |      |
|-------------|----------|-----|----|-------|-------|-------------------------|---|---|------|------|
| LEA CT-S_LG | T1940CTS | CTS | MI | 370 € | 402 € | FM-M2<br>FM-M4<br>PD-F0 | 1 | 1 | 8.5  | 0.10 |
| LEA CT-M_LG | T1940CTM | CTM | MI | 435 € | 472 € | FM-M2<br>FM-M4<br>PD-F0 | 1 | 1 | 10.5 | 0.11 |
| LEA CT-L_LG | T1940CTL | CTL | MI | 537 € | 590 € | FM-M2<br>FM-M4<br>PD-F0 | 1 | 1 | 12.5 | 0.16 |

### Lea Ceramic

Top 13 mm. thk | GMA Top 16 mm. thk

|             |          |     |    | GKA   | GKB   | GMA   |                         |   |   |      |      |
|-------------|----------|-----|----|-------|-------|-------|-------------------------|---|---|------|------|
| LEA CT-S_KR | T1940CTS | CTS | MI | 454 € | 475 € | 504 € | FM-M2<br>FM-M4<br>PD-F0 | 1 | 1 | 8.5  | 0.10 |
| LEA CT-M_KR | T1940CTM | CTM | MI | 509 € | 536 € | 573 € | FM-M2<br>FM-M4<br>PD-F0 | 1 | 1 | 10.5 | 0.11 |
| LEA CT-L_KR | T1940CTL | CTL | MI | 662 € | 693 € | 739 € | FM-M2<br>FM-M4<br>PD-F0 | 1 | 1 | 12.5 | 0.16 |

## Frame finishes

### Metal

**MI** WHITE **BB**, BROWN **E6**, SAND **EC**, WHITE PEARL **EF**, GRAPHITE **EG**, BLACK **EN**

## Top finishes

### Wood

**LI1** Stained BLACK **I04**, Stained NATURAL **I40**, Stained WHITENED **I60**, Stained DESERT **I61**, Stained LIGHT GREY **I62**, Stained DARK GREY **I63**

**LI2** NATURAL OAK **I22**, FLAMED WALNUT **I24**

### Crystal Ceramic and Ceramic

**GKA** CHARCOAL SAVOIA **K11**, CEMENT SAVOIA **K12**

**GKB** WHITE CALCE **K24**, BLACK CALCE **K25**, TORTORA CALCE **K26**, PIASENTINA STONE TAUPE Materica **K55**, TERRACOTTA Matt **K90**, MATT GREEN **K91**

### Crystal Ceramic and Ceramic

**GMA** MARBLE CALACATTA GLOSSY WHITE **K32**, BLACK GREEK MARBLE **K33**, MARBLE GLOSSY NOIR DESIR **K35**, MARBLE CALACATTA MATT WHITE **K42**, MARBLE MATT NOIR DESIR **K45**, MARBLE MATT GREEN TINOS **K46**, MARBLE STATUARIO WHITE MATT **K47**, MARBLE CALACAT BLACK Bush Hammered **K50**

## Optionals:

|              |                        | Value   | Options/notes  |
|--------------|------------------------|---------|--|
| <b>FM-M2</b> | Indoor matt metal M2   | + 87 €  | ASH GREY <b>ES</b> , BLUE SAPPHIRE <b>EE</b> , BLUE TURQUOISE <b>EH</b> , BRONZE <b>E2</b> , BULGARO RED <b>FP</b> , CHERRY RED <b>EQ</b> , DARK GREEN <b>EL</b> , FACEPOWDER PINK <b>E8</b> , FANGO <b>E3</b> , GOLDEN YELLOW <b>EO</b> , LIGHT BLUE <b>EO</b> , LIGHT GREY <b>ET</b> , OCEAN BLUE <b>E1</b> , OCHER YELLOW <b>E7</b> , PAPAYA ORANGE <b>EA</b> , PASTEL YELLOW <b>E4</b> , PINE GREEN <b>EJ</b> , RED <b>ER</b> , SAGE GREEN <b>E9</b> |
| <b>FM-M4</b> | Indoor glossy Metal M4 | + 153 € | BLACK NICKEL <b>DZ</b> , CHAMPAGNE GOLD <b>DG</b> , GOLDEN BRONZE <b>DB</b> , MATT BLACK NICKEL <b>DY</b> , MATT GOLDEN BRONZE <b>DC</b> , PINK GOLD <b>DR</b>   |
| <b>PD-F0</b> | Felt pad feet          | + 6 €   | PD-F0  |

### Lea CTS

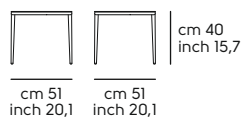

### Lea CTM

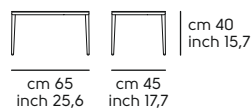

### Lea CTL

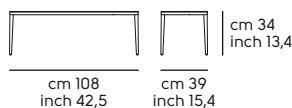

# Ola design Paolo Vernier

## Coffee Table OLA

Frame in: metal



| Version | Code | Mod. | -- | Frame and Top | Optional | Q.ty | boxes | Kg | M <sup>3</sup> |
|---------|------|------|----|---------------|----------|------|-------|----|----------------|
|---------|------|------|----|---------------|----------|------|-------|----|----------------|

### Ola Metal

Top 1 mm. thk

|            |          |     |    | M1    | M2    | O1    | O2    |  |   |   |    |      |
|------------|----------|-----|----|-------|-------|-------|-------|--|---|---|----|------|
| OLA CT 45  | T1400M04 | 45  | -- | 127 € | 173 € | 204 € | 240 € |  | 1 | 1 | 6  | 0.11 |
| OLA CT 105 | T1400M10 | 105 | -- | 244 € | 311 € | 374 € | 426 € |  | 1 | 1 | 10 | 0.24 |

### Frame and Top finishes

#### Metal

|           |  |
|-----------|--|
| <b>M1</b> | WHITE <b>BB</b> , INDUSTRIAL <b>E5</b> , BROWN <b>E6</b> , SAND <b>EC</b> , WHITE PEARL <b>EF</b> , GRAPHITE <b>EG</b> , BLACK <b>EN</b> |
|-----------|--|

#### Metal

|           |  |
|-----------|--|
| <b>M2</b> | LIGHT BLUE <b>E0</b> , OCEAN BLUE <b>E1</b> , BRONZE <b>E2</b> , FANGO <b>E3</b> , PASTEL YELLOW <b>E4</b> , OCHER YELLOW <b>E7</b> , FACEPOWDER PINK <b>E8</b> , SAGE GREEN <b>E9</b> , PAPAYA ORANGE <b>EA</b> , BLUE SAPPHIRE <b>EE</b> , BLUE TURQUOISE <b>EH</b> , PINE GREEN <b>EJ</b> , DARK GREEN <b>EL</b> , GOLDEN YELLOW <b>EO</b> , CHERRY RED <b>EQ</b> , RED <b>ER</b> , ASH GREY <b>ES</b> , LIGHT GREY <b>ET</b> , BULGARO RED <b>FP</b> |
|-----------|--|

#### Metal Outdoor

|           |  |
|-----------|--|
| <b>O1</b> | Outdoor BROWN <b>E6</b> , Outdoor WHITE <b>BB</b> , Outdoor SAND <b>EC</b> , Outdoor WHITE PEARL <b>EF</b> , Outdoor GRAFITE <b>EG</b> , Outdoor BLACK <b>EN</b> |
|-----------|--|

#### Metal Outdoor

|           |  |
|-----------|--|
| <b>O2</b> | Outdoor LIGHT BLUE <b>E0</b> , Outdoor OCEAN BLUE <b>E1</b> , Outdoor BRONZE <b>E2</b> , Outdoor FANGO <b>E3</b> , Outdoor PASTEL YELLOW <b>E4</b> , Outdoor OCHER YELLOW <b>E7</b> , Outdoor FACEPOWDER PINK <b>E8</b> , Outdoor SAGE GREEN <b>E9</b> , Outdoor BLUE SAPPHIRE <b>EE</b> , Outdoor BLUE TURQUOISE <b>EH</b> , Outdoor PINE GREEN <b>EJ</b> , Outdoor DARK GREEN <b>EL</b> , Outdoor GOLD YELLOW <b>EO</b> , Outdoor RED BULGARO <b>FP</b> , Outdoor CHERRY RED <b>EQ</b> , Outdoor RED <b>ER</b> , Outdoor ASH GREY <b>ES</b> , Outdoor LIGHT GREY <b>ET</b> , Outdoor PAPAYA ORANGE <b>EA</b> |
|-----------|--|

### Ola 45

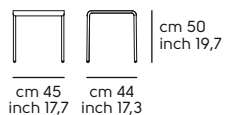

### Ola 105

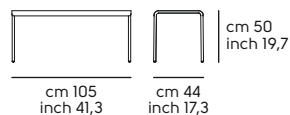

# P47 design Franco Poli

## Coffee Table P47

Frame in: metal



| Version               | Code     | Mod. | Frame | Metal Top (Hide CK) |       |       | Optional                         | Q.ty | boxes | Kg   | M <sup>3</sup> |
|-----------------------|----------|------|-------|---------------------|-------|-------|----------------------------------|------|-------|------|----------------|
| <b>P47 Metal-Hide</b> |          |      |       |                     |       |       |                                  |      |       |      |                |
| Top 5 mm. thk         |          |      |       |                     |       |       |                                  |      |       |      |                |
|                       |          |      |       | M1                  | M2    | M5    |                                  |      |       |      |                |
| P47 CT-S H60          | T2140CTS | CTS  | M1    | 402 €               | 443 € | 420 € | FM-M2<br>FM-M3<br>FM-M4<br>RV-CT | 1    | 1     | 9    | 0.128          |
| P47 CT-M H50          | T2140CTM | CTM  | M1    | 494 €               | 534 € | 510 € | FM-M2<br>FM-M3<br>FM-M4<br>RV-CT | 1    | 1     | 11   | 0.160          |
| P47 CT-L H40          | T2140CTL | CTL  | M1    | 575 €               | 616 € | 593 € | FM-M2<br>FM-M3<br>FM-M4<br>RV-CT | 1    | 1     | 13.5 | 0.182          |

### Frame finishes

#### Metal

**M1** WHITE **BB**, BROWN **E6**, SAND **EC**, WHITE PEARL **EF**, GRAPHITE **EG**, BLACK **EN**

### Hide finishes

#### Upholstery

**CK** HIDE\_TK

### Top finishes

#### Metal

**M1** WHITE **BB**, BROWN **E6**, SAND **EC**, WHITE PEARL **EF**, GRAPHITE **EG**, BLACK **EN**

**M2** LIGHT BLUE **E0**, OCEAN BLUE **E1**, BRONZE **E2**, FANGO **E3**, PASTEL YELLOW **E4**, OCHER YELLOW **E7**, FACEPOWDER PINK **E8**, SAGE GREEN **E9**, PAPAYA ORANGE **EA**, BLUE SAPPHIRE **EE**, BLUE TURQUOISE **EH**, PINE GREEN **EJ**, DARK GREEN **EL**, GOLDEN YELLOW **EO**, CHERRY RED **EQ**, RED **ER**, ASH GREY **ES**, LIGHT GREY **ET**, BULGARRO RED **FP**

**M5** SATIN STAINLESS STEEL **HS**

### Optionals:

|              | Value  | Options/notes   |
|--------------|--------|---|
| <b>FM-M2</b> | + 66 € | ASH GREY <b>ES</b> , BLUE SAPPHIRE <b>EE</b> , BLUE TURQUOISE <b>EH</b> , BRONZE <b>E2</b> , BULGARRO RED <b>FP</b> , CHERRY RED <b>EQ</b> , DARK GREEN <b>EL</b> , FACEPOWDER PINK <b>E8</b> , FANGO <b>E3</b> , GOLDEN YELLOW <b>EO</b> , LIGHT BLUE <b>E0</b> , LIGHT GREY <b>ET</b> , OCEAN BLUE <b>E1</b> , OCHER YELLOW <b>E7</b> , PAPAYA ORANGE <b>EA</b> , PASTEL YELLOW <b>E4</b> , PINE GREEN <b>EJ</b> , RED <b>ER</b> , SAGE GREEN <b>E9</b> |
| <b>FM-M3</b> | + 44 € | CHROME <b>CC</b>  |
| <b>FM-M4</b> | + 87 € | BLACK NICKEL <b>DZ</b> , CHAMPAGNE GOLD <b>DG</b> , GOLDEN BRONZE <b>DB</b> , MATT BLACK NICKEL <b>DY</b> , MATT GOLDEN BRONZE <b>DC</b> , PINK GOLD <b>DR</b>  |
| <b>RV-CT</b> | + 93 € | TUSCAN HIDE   |

### P47 CTS

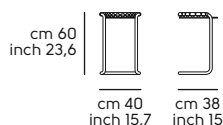

### P47 CTM

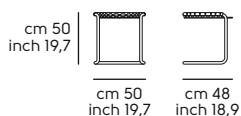

### P47 CTL

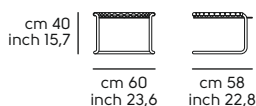

# Paw design Studio Pastina

## Coffee Table PAW

Frame in: metal



| Version | Code | Mod. | -- | Frame and Top | Optional | Q.ty | boxes | Kg | M <sup>3</sup> |
|---------|------|------|----|---------------|----------|------|-------|----|----------------|
|---------|------|------|----|---------------|----------|------|-------|----|----------------|

### Paw Metal

Top 6 mm. thk

|                  |          |     |  | M1    | M2    |  |   |   |    |      |
|------------------|----------|-----|--|-------|-------|--|---|---|----|------|
| PAW H30 50x90_MT | T2050H30 | CTS |  | 457 € | 509 € |  | 1 | 1 | 12 | 0.14 |
| PAW H40 50x50_MT | T2050H40 | CTM |  | 397 € | 457 € |  | 1 | 1 | 8  | 0.11 |
| PAW H50 50x90_MT | T2050H50 | CTL |  | 488 € | 550 € |  | 1 | 1 | 13 | 0.24 |

| Version | Code | Mod. | Frame | Top | Optional | Q.ty | boxes | Kg | M <sup>3</sup> |
|---------|------|------|-------|-----|----------|------|-------|----|----------------|
|---------|------|------|-------|-----|----------|------|-------|----|----------------|

### Paw Ceramic

Top 12 mm. thk

|                  |          |     |    | GKA   | GKB   | GMA   |       |   |   |    |      |
|------------------|----------|-----|----|-------|-------|-------|-------|---|---|----|------|
| PAW H30 50x90_KR | T2051H30 | CTS | M1 | 825 € | 835 € | 904 € | FM-M2 | 1 | 1 | 13 | 0.14 |
| PAW H40 50x50_KR | T2051H40 | CTM | M1 | 650 € | 661 € | 696 € | FM-M2 | 1 | 1 | 9  | 0.11 |
| PAW H50 50x90_KR | T2051H50 | CTL | M1 | 853 € | 865 € | 934 € | FM-M2 | 1 | 1 | 14 | 0.24 |

### Note:

OUTDOOR USE

### Frame and Top finishes

#### Metal

| M1  | M2  |
|---|---|
| WHITE <b>BB</b> , BROWN <b>E6</b> , SAND <b>EC</b> , WHITE PEARL <b>EF</b> , GRAPHITE <b>EG</b> , BLACK <b>EN</b> | LIGHT BLUE <b>E0</b> , OCEAN BLUE <b>E1</b> , FANGO <b>E3</b> , PASTEL YELLOW <b>E4</b> , OCHER YELLOW <b>E7</b> , FACEPOWDER PINK <b>E8</b> , SAGE GREEN <b>E9</b> , PAPAYA ORANGE <b>EA</b> , BLUE SAPPHIRE <b>EE</b> , BLUE TURQUOISE <b>EH</b> , PINE GREEN <b>EJ</b> , DARK GREEN <b>EL</b> , GOLDEN YELLOW <b>EO</b> , CHERRY RED <b>EQ</b> , RED <b>ER</b> , ASH GREY <b>ES</b> , LIGHT GREY <b>ET</b> , BRONZE <b>EZ</b> + TRANSP., BULGARO RED <b>FP</b> |

#### Top finishes

#### Crystal Ceramic and Ceramic

| GKA   | GKB  |
|---|--|
| CHARCOAL SAVOIA <b>K11</b> , CEMENT SAVOIA <b>K12</b>   | WHITE CALCE <b>K24</b> , BLACK CALCE <b>K25</b> , TORTORA CALCE <b>K26</b> , PIASENTINA STONE TAUPE Materica <b>K55</b> , TERRACOTTA Matt <b>K90</b> , MATT GREEN <b>K91</b> |
| MARBLE CALACATTA GLOSSY WHITE <b>K32</b> , BLACK GREEK MARBLE <b>K33</b> , MARBLE GLOSSY NOIR DESIR <b>K35</b> , MARBLE CALACATTA MATT WHITE <b>K42</b> , MARBLE MATT NOIR DESIR <b>K45</b> , MARBLE MATT GREEN TINOS <b>K46</b> , MARBLE STATUARIO WHITE MATT <b>K47</b> , MARBLE CALACAT BLACK Bush Hammered <b>K50</b> |  |

#### Optionals:

|              | Value                | Options/notes   |
|--------------|----------------------|---|
| <b>FM-M2</b> | Indoor matt metal M2 | + 60 €  |
|              |                      | ASH GREY <b>ES</b> , BLUE SAPPHIRE <b>EE</b> , BLUE TURQUOISE <b>EH</b> , BRONZE <b>EZ</b> + TRANSP., BULGARO RED <b>FP</b> , CHERRY RED <b>EQ</b> , DARK GREEN <b>EL</b> , FACEPOWDER PINK <b>E8</b> , FANGO <b>E3</b> , GOLDEN YELLOW <b>EO</b> , LIGHT BLUE <b>E0</b> , LIGHT GREY <b>ET</b> , OCEAN BLUE <b>E1</b> , OCHER YELLOW <b>E7</b> , PAPAYA ORANGE <b>EA</b> , PASTEL YELLOW <b>E4</b> , PINE GREEN <b>EJ</b> , RED <b>ER</b> , SAGE GREEN <b>E9</b> |

#### Paw CTS

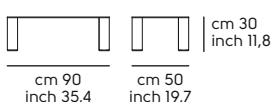

#### Paw CTM

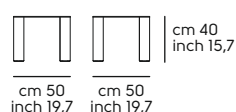

#### Paw CTL

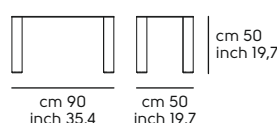

# Plissé design Paola Navone

## Coffee Table PLISSÉ

Frame in: metal



| Version              | Code       | Mod.    | Frame | Top     | Optional | Q.ty  | boxes | Kg | M <sup>3</sup> |      |
|----------------------|------------|---------|-------|---------|----------|-------|-------|----|----------------|------|
| <b>Plissé Veneer</b> |            |         |       |         |          |       |       |    |                |      |
| Top 20 mm. thk       |            |         |       |         |          |       |       |    |                |      |
|                      |            |         |       | LI1     | LI2      |       |       |    |                |      |
| PLISSÉ H26 D80       | T2220CT26L | H26 D80 | M1    | 1.110 € | 1.170 €  | FM-M2 | 1     | 2  | 18.5           | 0.12 |
| PLISSÉ H30 D70       | T2220CT30L | H30 D70 | M1    | 1.090 € | 1.143 €  | FM-M2 | 1     | 2  | 19             | 0.12 |
| PLISSÉ H40 D50       | T2220CT40L | H40 D50 | M1    | 975 €   | 995 €    | FM-M2 | 1     | 2  | 15             | 0.08 |
| PLISSÉ H50 D40       | T2220CT50L | H50 D40 | M1    | 990 €   | 1.025 €  | FM-M2 | 1     | 2  | 12.5           | 0.08 |

| Version             | Code       | Mod.    | Frame | Top   | Optional | Q.ty  | boxes | Kg | M <sup>3</sup> |      |
|---------------------|------------|---------|-------|-------|----------|-------|-------|----|----------------|------|
| <b>Plissé Metal</b> |            |         |       |       |          |       |       |    |                |      |
| Top 3 mm. thk       |            |         |       |       |          |       |       |    |                |      |
|                     |            |         |       | M1    | M2       |       |       |    |                |      |
| PLISSÉ H26 D80      | T2220CT26M | H26 D80 | M1    | 660 € | 696 €    | FM-M2 | 1     | 2  | 23             | 0.12 |
| PLISSÉ H30 D70      | T2220CT30M | H30 D70 | M1    | 732 € | 760 €    | FM-M2 | 1     | 2  | 20.5           | 0.12 |
| PLISSÉ H40 D50      | T2220CT40M | H40 D50 | M1    | 556 € | 585 €    | FM-M2 | 1     | 2  | 13             | 0.08 |
| PLISSÉ H50 D40      | T2220CT50M | H50 D40 | M1    | 575 € | 604 €    | FM-M2 | 1     | 2  | 12             | 0.08 |

| Version            | Code       | Mod.    | Frame | Top   | Optional | Q.ty  | boxes | Kg | M <sup>3</sup> |      |
|--------------------|------------|---------|-------|-------|----------|-------|-------|----|----------------|------|
| <b>Plissé Hide</b> |            |         |       |       |          |       |       |    |                |      |
| Top 5 mm. thk      |            |         |       |       |          |       |       |    |                |      |
|                    |            |         |       | CU    | CT       |       |       |    |                |      |
| PLISSÉ H26 D80     | T2220CT26C | H26 D80 | M1    | 713 € | 765 €    | FM-M2 | 1     | 2  | 23             | 0.12 |
| PLISSÉ H30 D70     | T2220CT30C | H30 D70 | M1    | 788 € | 830 €    | FM-M2 | 1     | 2  | 20.5           | 0.12 |
| PLISSÉ H40 D50     | T2220CT40C | H40 D50 | M1    | 585 € | 620 €    | FM-M2 | 1     | 2  | 13             | 0.08 |
| PLISSÉ H50 D40     | T2220CT50C | H50 D40 | M1    | 608 € | 640 €    | FM-M2 | 1     | 2  | 12             | 0.08 |

| Version               | Code       | Mod.    | Frame | Top   | Optional | Q.ty  | boxes | Kg | M <sup>3</sup> |      |      |
|-----------------------|------------|---------|-------|-------|----------|-------|-------|----|----------------|------|------|
| <b>Plissé Ceramic</b> |            |         |       |       |          |       |       |    |                |      |      |
| Top 6 mm. thk         |            |         |       |       |          |       |       |    |                |      |      |
|                       |            |         |       | GKA   | GKB      | GMA   |       |    |                |      |      |
| PLISSÉ H26 D80        | T2220CT26V | H26 D80 | M1    | 752 € | 782 €    | 811 € | FM-M2 | 1  | 2              | 23.5 | 0.12 |
| PLISSÉ H30 D70        | T2220CT30V | H30 D70 | M1    | 840 € | 860 €    | 897 € | FM-M2 | 1  | 2              | 21.5 | 0.12 |
| PLISSÉ H40 D50        | T2220CT40V | H40 D50 | M1    | 616 € | 633 €    | 650 € | FM-M2 | 1  | 2              | 14.5 | 0.08 |
| PLISSÉ H50 D40        | T2220CT50V | H50 D40 | M1    | 670 € | 688 €    | 704 € | FM-M2 | 1  | 2              | 13.5 | 0.08 |

| Version | Code | Mod. | Frame | Top | Optional | Q.ty | boxes | Kg | M <sup>3</sup> |
|---------|------|------|-------|-----|----------|------|-------|----|----------------|
|---------|------|------|-------|-----|----------|------|-------|----|----------------|

### Plissé Marble

Top 20 mm. thk

|                |            |         |    | GMM     |       |   |   |    |      |
|----------------|------------|---------|----|---------|-------|---|---|----|------|
| PLISSÉ H26 D80 | T2220CT26Z | H26 D80 | M1 | 1.160 € | FM-M2 | 1 | 2 | 35 | 0.12 |
| PLISSÉ H30 D70 | T2220CT30Z | H30 D70 | M1 | 1.190 € | FM-M2 | 1 | 2 | 30 | 0.12 |
| PLISSÉ H40 D50 | T2220CT40Z | H40 D50 | M1 | 965 €   | FM-M2 | 1 | 2 | 17 | 0.08 |
| PLISSÉ H50 D40 | T2220CT50Z | H50 D40 | M1 | 1.110 € | FM-M2 | 1 | 2 | 15 | 0.08 |

#### Note:

--

### Frame and Top finishes

#### Metal

| M1  | M2   |
|---|--|
| WHITE <b>BB</b> , BROWN <b>E6</b> , SAND <b>EC</b> , WHITE PEARL <b>EF</b> , GRAPHITE <b>EG</b> , BLACK <b>EN</b> | LIGHT BLUE <b>E0</b> , OCEAN BLUE <b>E1</b> , BRONZE <b>E2</b> , FANGO <b>E3</b> , PASTEL YELLOW <b>E4</b> , OCHER YELLOW <b>E7</b> , FACEPOWDER PINK <b>E8</b> , SAGE GREEN <b>E9</b> , PAPAYA ORANGE <b>EA</b> , BLUE SAPPHIRE <b>EE</b> , BLUE TURQUOISE <b>EH</b> , PINE GREEN <b>EJ</b> , DARK GREEN <b>EL</b> , GOLDEN YELLOW <b>EO</b> , CHERRY RED <b>EQ</b> , RED <b>ER</b> , ASH GREY <b>ES</b> , LIGHT GREY <b>ET</b> , BRONZE <b>EZ</b> + TRANSP., BULGARO RED <b>FP</b> |

### Top finishes

#### Wood

|            |  |
|------------|--|
| <b>L11</b> | Stained BLACK <b>I04</b> , Stained WHITE <b>I05</b> , Stained CHERRY RED <b>I09</b> , Stained DARK BROWN <b>I26</b> , Stained NATURAL <b>I40</b> , Stained NATURAL OAK <b>I52</b> , Stained WHITENED <b>I60</b> , Stained DESERT <b>I61</b> , Stained LIGHT GREY <b>I62</b> , Stained DARK GREY <b>I63</b> |
| <b>L12</b> | NATURAL OAK <b>I22</b> , FLAMED WALNUT <b>I24</b>  |

#### Hide

|           |             |
|-----------|-------------|
| <b>CU</b> | HIDE        |
| <b>CT</b> | TUSCAN HIDE |

#### Crystal Ceramic and Ceramic

|            |   |
|------------|---|
| <b>GKA</b> | CHARCOAL SAVOIA <b>K11</b> , CEMENT SAVOIA <b>K12</b>   |
| <b>GKB</b> | WHITE CALCE <b>K24</b> , BLACK CALCE <b>K25</b> , TORTORA CALCE <b>K26</b> , PIASENTINA STONE TAUPE Materica <b>K55</b> , TERRACOTTA Matt <b>K90</b> , MATT GREEN <b>K91</b>  |
| <b>GMA</b> | MARBLE CALACATTA GLOSSY WHITE <b>K32</b> , BLACK GREEK MARBLE <b>K33</b> , MARBLE GLOSSY NOIR DESIR <b>K35</b> , MARBLE CALACATTA MATT WHITE <b>K42</b> , MARBLE MATT NOIR DESIR <b>K45</b> , MARBLE MATT GREEN TINOS <b>K46</b> , MARBLE STATUARIO WHITE MATT <b>K47</b> , MARBLE CALACAT BLACK Bush Hammered <b>K50</b> |

#### Marble

|            |   |
|------------|---|
| <b>GMM</b> | BEIGE TRAVERTINO ROMANO <b>MB2</b> , WHITE CALACATTA VAGLI <b>MB4</b> , BLACK MARQUINIA <b>MN4</b> , GREEN TINOS <b>MVE</b> |
|------------|---|

### Optionals:

|              | Value  | Options/notes  |
|--------------|--------|--|
| <b>FM-M2</b> | + 50 € | ASH GREY <b>ES</b> , BLUE SAPPHIRE <b>EE</b> , BLUE TURQUOISE <b>EH</b> , BRONZE <b>E2</b> , BRONZE <b>EZ</b> + TRANSP., BULGARO RED <b>FP</b> , CHERRY RED <b>EQ</b> , DARK GREEN <b>EL</b> , FACEPOWDER PINK <b>E8</b> , FANGO <b>E3</b> , GOLDEN YELLOW <b>EO</b> , LIGHT BLUE <b>E0</b> , LIGHT GREY <b>ET</b> , OCEAN BLUE <b>E1</b> , OCHER YELLOW <b>E7</b> , PAPAYA ORANGE <b>EA</b> , PASTEL YELLOW <b>E4</b> , PINE GREEN <b>EJ</b> , RED <b>ER</b> , SAGE GREEN <b>E9</b> |

#### Plissé H26 D80

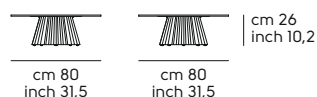

#### Plissé H30 D70

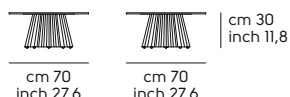

#### Plissé H40 D50

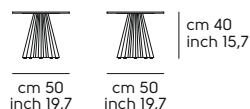

#### Plissé H50 D40

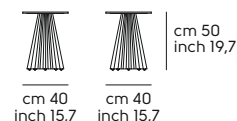

# Suite design AtelierNanni

## Coffee Table SUITE

Frame in: wood



| Version               | Code     | Mod.         | Frame | Top   | Optional | Q.ty | boxes | Kg  | M <sup>3</sup> |
|-----------------------|----------|--------------|-------|-------|----------|------|-------|-----|----------------|
| <b>Suite Hide</b>     |          |              |       |       |          |      |       |     |                |
| Top 28 mm. thk        |          |              |       |       |          |      |       |     |                |
|                       |          |              |       | CU    | CT       |      |       |     |                |
| SUITE CT H30 D. 55_CU | T1750C30 | H30<br>D55   | LF1   | 330 € | 386 €    | 1    | 1     | 5   | 0.12           |
| SUITE CT H30 55x55_CU | T1750C35 | H30<br>55x55 | LF1   | 366 € | 430 €    | 1    | 1     | 5   | 0.12           |
| SUITE CT H30 70x35_CU | T1750C37 | H30<br>70x35 | LF1   | 380 € | 423 €    | 1    | 1     | 5   | 0.11           |
| SUITE CT H40 D. 55_CU | T1750C40 | H40<br>D55   | LF1   | 342 € | 398 €    | 1    | 1     | 5.5 | 0.16           |
| SUITE CT H40 55x55_CU | T1750C45 | H40<br>55x55 | LF1   | 381 € | 441 €    | 1    | 1     | 5.5 | 0.16           |
| SUITE CT H40 70x35_CU | T1750C47 | H40<br>70x35 | LF1   | 391 € | 456 €    | 1    | 1     | 5.5 | 0.12           |
| SUITE CT H50 D. 55_CU | T1750C50 | H50<br>D55   | LF1   | 355 € | 411 €    | 1    | 1     | 6   | 0.20           |
| SUITE CT H50 55x55_CU | T1750C55 | H50<br>55x55 | LF1   | 392 € | 456 €    | 1    | 1     | 6   | 0.20           |
| SUITE CT H50 70x35_CU | T1750C57 | H50<br>70x35 | LF1   | 406 € | 467 €    | 1    | 1     | 6   | 0.16           |

## Suite Ceramic

Top 30 mm. thk

|                       |          |              |     | GKB   | GMA   |   |   |     |      |
|-----------------------|----------|--------------|-----|-------|-------|---|---|-----|------|
| SUITE CT H30 D. 55_KR | T1750H30 | H30<br>D55   | LF1 | 490 € | 509 € | 1 | 1 | 5   | 0.12 |
| SUITE CT H30 55x55_KR | T1750H35 | H30<br>55x55 | LF1 | 555 € | 577 € | 1 | 1 | 5   | 0.12 |
| SUITE CT H30 70x35_KR | T1750H37 | H30<br>70x35 | LF1 | 535 € | 558 € | 1 | 1 | 5   | 0.11 |
| SUITE CT H40 D. 55_KR | T1750H40 | H40<br>D55   | LF1 | 502 € | 521 € | 1 | 1 | 5.5 | 0.16 |
| SUITE CT H40 55x55_KR | T1750H45 | H40<br>55x55 | LF1 | 568 € | 590 € | 1 | 1 | 5.5 | 0.16 |
| SUITE CT H40 70x35_KR | T1750H47 | H40<br>70x35 | LF1 | 547 € | 570 € | 1 | 1 | 5.5 | 0.12 |
| SUITE CT H50 D. 55_KR | T1750H50 | H50<br>D55   | LF1 | 512 € | 531 € | 1 | 1 | 6   | 0.20 |
| SUITE CT H50 55x55_KR | T1750H55 | H50<br>55x55 | LF1 | 582 € | 604 € | 1 | 1 | 6   | 0.20 |
| SUITE CT H50 70x35_KR | T1750H57 | H50<br>70x35 | LF1 | 560 € | 583 € | 1 | 1 | 6   | 0.16 |

**Frame finishes**

**Solid ashwood**

|            |  |
|------------|--|
| <b>LFI</b> | Ash wood stained BLACK <b>F04</b> , Ash wood stained WHITE <b>F05</b> , Ash wood stained CHERRY RED <b>F09</b> , Ash wood stained FLAMED WALNUT <b>F24</b> , Ash wood stained DARK BROWN <b>F26</b> , Ash wood stained NATURAL <b>F40</b> , Ash wood stained NATURAL OAK <b>F52</b> , Ash wood stained WHITENED <b>F60</b> , Ash wood stained DESERT <b>F61</b> , Ash wood stained LIGHT GREY <b>F62</b> , Ash wood stained DARK GREY <b>F63</b> |
|------------|--|

**Top finishes**

| Hide      |             |
|-----------|-------------|
| <b>CU</b> | HIDE        |
| <b>CT</b> | TUSCAN HIDE |

| Crystal Ceramic and Ceramic |   |
|-----------------------------|---|
| <b>GKB</b>                  | WHITE CALCE <b>K24</b> , BLACK CALCE <b>K25</b> , TORTORA CALCE <b>K26</b> , PIASENTINA STONE TAUPE Materica <b>K55</b> , TERRACOTTA Matt <b>K90</b> , MATT GREEN <b>K91</b>  |
| <b>GMA</b>                  | MARBLE CALACATTA GLOSSY WHITE <b>K32</b> , BLACK GREEK MARBLE <b>K33</b> , MARBLE GLOSSY NOIR DESIR <b>K35</b> , MARBLE CALACATTA MATT WHITE <b>K42</b> , MARBLE MATT NOIR DESIR <b>K45</b> , MARBLE MATT GREEN TINOS <b>K46</b> , MARBLE STATUARIO WHITE MATT <b>K47</b> , MARBLE CALACAT BLACK Bush Hammered <b>K50</b> |

**Suite H30 D55**

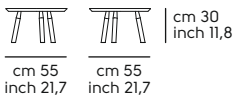

**Suite H30 55x55**

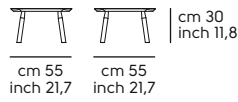

**Suite H30 70x35**

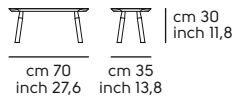

**Suite H40 D55**

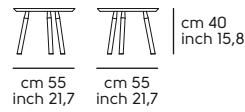

**Suite H40 55x55**

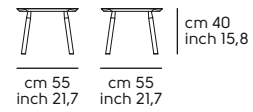

**Suite H40 70x35**

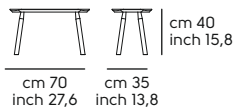

**Suite H50 D55**

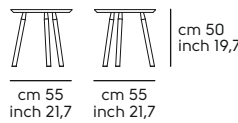

**Suite H50 55x55**

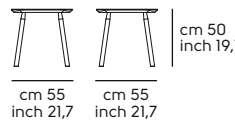

**Suite H50 70x35**

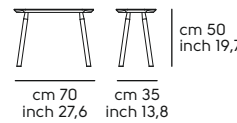

# Trampoliere design Roberto Paoli

## Coffee Table TRAMPOLIERE

Frame in: metal



| Version | Code | Mod. | Frame | Top | Optional | Q.ty | boxes | Kg | M <sup>3</sup> |
|---------|------|------|-------|-----|----------|------|-------|----|----------------|
|---------|------|------|-------|-----|----------|------|-------|----|----------------|

### Trampoliere Melamine HL

Top 18 mm. thk

|                       |          |     |    | HL1   |       |   |   |      |      |
|-----------------------|----------|-----|----|-------|-------|---|---|------|------|
| TRAMPOLIERE H34 D. 70 | T1550H34 | H34 | M1 | 225 € | FM-M2 | 1 | 2 | 15.5 | 0.20 |
| TRAMPOLIERE H44 D. 60 | T1550H44 | H44 | M1 | 197 € | FM-M2 | 1 | 2 | 13.5 | 0.16 |
| TRAMPOLIERE H54 D. 50 | T1550H54 | H54 | M1 | 184 € | FM-M2 | 1 | 2 | 14.5 | 0.15 |

### Trampoliere HPL

Top 10 mm. thk

|                       |          |     |    | HH1   | HH2   | HH3   |       |   |   |      |      |
|-----------------------|----------|-----|----|-------|-------|-------|-------|---|---|------|------|
| TRAMPOLIERE H34 D. 70 | T1550H34 | H34 | M1 | 330 € | 343 € | 370 € | FM-M2 | 1 | 2 | 15.5 | 0.20 |
| TRAMPOLIERE H44 D. 60 | T1550H44 | H44 | M1 | 312 € | 326 € | 340 € | FM-M2 | 1 | 2 | 13.5 | 0.16 |
| TRAMPOLIERE H54 D. 50 | T1550H54 | H54 | M1 | 266 € | 275 € | 283 € | FM-M2 | 1 | 2 | 14.5 | 0.15 |

### Frame finishes

#### Metal

|           |   |
|-----------|---|
| <b>MI</b> | WHITE <b>BB</b> , BROWN <b>E6</b> , SAND <b>EC</b> , WHITE PEARL <b>EF</b> , GRAPHITE <b>EG</b> , BLACK <b>EN</b> |
|-----------|---|

### Top finishes

#### Melamine

|            |  |
|------------|--|
| <b>HL1</b> | WHITE <b>M01</b> , GRAFITE <b>M02</b> , BLACK <b>M04</b> , SAND <b>M07</b> |
|------------|--|

#### HPL

|            |  |
|------------|--|
| <b>HH1</b> | WHITE/Black Core <b>HB4</b> , BLACK/Black Core <b>HN4</b>  |
| <b>HH2</b> | CEMENT/Black Core <b>HC6</b> , CORTEN/Brown Core <b>HC7</b> , DARK GREY/Black Core <b>HGW</b>  |
| <b>HH3</b> | ST WHITE/White Core <b>AB4</b> , ST SAND/Sand Core <b>ACR</b> , ST GRAPHITE GREY/ Grafite Core <b>AGD</b> , ST BLACK/Black Core <b>AN4</b> , ST TORTORA/Tortora Core <b>ATR</b> , ST RED NAMIB/Red Core <b>FAM</b> , ST YELLOW EVORA/Yellow Core <b>FGO</b> , ST RED BULGARO/Red Core <b>FRB</b> , ST GREEN KITAMI/Green Core <b>FVK</b> |

### Optionals:

|              | Value                | Options/notes  |
|--------------|----------------------|--|
| <b>FM-M2</b> | Indoor matt metal M2 | + 60 €<br>ASH GREY <b>ES</b> , BLUE SAPPHIRE <b>EE</b> , BLUE TURQUOISE <b>EH</b> , BRONZE <b>E2</b> , BULGARO RED <b>FP</b> , CHERRY RED <b>EQ</b> , DARK GREEN <b>EL</b> , FACEPOWDER PINK <b>EB</b> , FANGO <b>E3</b> , GOLDEN YELLOW <b>EO</b> , LIGHT BLUE <b>EO</b> , LIGHT GREY <b>ET</b> , OCEAN BLUE <b>EI</b> , OCHER YELLOW <b>E7</b> , PAPAYA ORANGE <b>EA</b> , PASTEL YELLOW <b>E4</b> , PINE GREEN <b>EJ</b> , RED <b>ER</b> , SAGE GREEN <b>E9</b> |

### Trampoliere H34

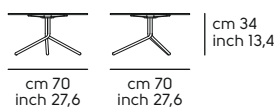

### Trampoliere H44

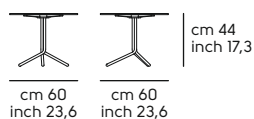

### Trampoliere H54

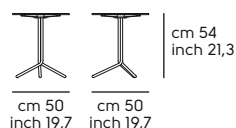

# Trip design Paolo Vernier

## Coffee Table TRIP

Frame in: metal



| Version          | Code     | Mod. | Frame | Top   | Optional | Q.ty           | boxes | Kg | M <sup>3</sup> |      |
|------------------|----------|------|-------|-------|----------|----------------|-------|----|----------------|------|
| <b>Trip Hide</b> |          |      |       |       |          |                |       |    |                |      |
| Top 6 mm. thk    |          |      |       |       |          |                |       |    |                |      |
|                  |          |      |       | CU    | CT       |                |       |    |                |      |
| TRIP H45_CU      | T0280C45 | H45  | M1    | 243 € | 268 €    | FM-M2<br>FM-M4 | 1     | 1  | 5              | 0.06 |
| TRIP H50_CU      | T0280C50 | H50  | M1    | 270 € | 296 €    | FM-M2<br>FM-M4 | 1     | 1  | 6              | 0.09 |
| TRIP H60_CU      | T0280C60 | H60  | M1    | 307 € | 332 €    | FM-M2<br>FM-M4 | 1     | 1  | 7              | 0.16 |

## Trip Ceramic

Top 8 mm. thk

|             |          |     |    |       |       |       |                |   |   |   |      |
|-------------|----------|-----|----|-------|-------|-------|----------------|---|---|---|------|
|             |          |     |    | GKA   | GKB   | GMA   |                |   |   |   |      |
| TRIP H45_KR | T0280H45 | H45 | M1 | 259 € | 278 € | 286 € | FM-M2<br>FM-M4 | 1 | 1 | 5 | 0.06 |
| TRIP H50_KR | T0280H50 | H50 | M1 | 293 € | 302 € | 314 € | FM-M2<br>FM-M4 | 1 | 1 | 6 | 0.09 |
| TRIP H60_KR | T0280H60 | H60 | M1 | 331 € | 342 € | 355 € | FM-M2<br>FM-M4 | 1 | 1 | 7 | 0.16 |

**Frame finishes**

**Metal**

|           |   |
|-----------|---|
| <b>MI</b> | WHITE <b>BB</b> , BROWN <b>E6</b> , SAND <b>EC</b> , WHITE PEARL <b>EF</b> , GRAPHITE <b>EG</b> , BLACK <b>EN</b> |
|-----------|---|

**Top finishes**

**Hide**

|           |             |
|-----------|-------------|
| <b>CU</b> | HIDE        |
| <b>CT</b> | TUSCAN HIDE |

**Crystal Ceramic and Ceramic**

|            |  |
|------------|--|
| <b>GKA</b> | CHARCOAL SAVOIA <b>K11</b> , CEMENT SAVOIA <b>K12</b>  |
| <b>GKB</b> | WHITE CALCE <b>K24</b> , BLACK CALCE <b>K25</b> , TORTORA CALCE <b>K26</b> , PIASENTINA STONE TAUPE Materica <b>K55</b> , TERRACOTTA Matt <b>K90</b> , MATT GREEN <b>K91</b> |

**Crystal Ceramic and Ceramic**

|            |   |
|------------|---|
| <b>GMA</b> | MARBLE CALACATTA GLOSSY WHITE <b>K32</b> , BLACK GREEK MARBLE <b>K33</b> , MARBLE GLOSSY NOIR DESIR <b>K35</b> , MARBLE CALACATTA MATT WHITE <b>K42</b> , MARBLE MATT NOIR DESIR <b>K45</b> , MARBLE MATT GREEN TINOS <b>K46</b> , MARBLE STATUARIO WHITE MATT <b>K47</b> , MARBLE CALACAT BLACK Bush Hammered <b>K50</b> |
|------------|---|

**Optionals:**

|              |                        | Value  | Options/notes  |
|--------------|------------------------|--------|--|
| <b>FM-M2</b> | Indoor matt metal M2   | + 55 € | ASH GREY <b>ES</b> , BLUE SAPPHIRE <b>EE</b> , BLUE TURQUOISE <b>EH</b> , BRONZE <b>E2</b> , BULGARO RED <b>FP</b> , CHERRY RED <b>EQ</b> , DARK GREEN <b>EL</b> , FACEPOWDER PINK <b>E8</b> , FANGO <b>E3</b> , GOLDEN YELLOW <b>EO</b> , LIGHT BLUE <b>EO</b> , LIGHT GREY <b>ET</b> , OCEAN BLUE <b>E1</b> , OCHER YELLOW <b>E7</b> , PAPAYA ORANGE <b>EA</b> , PASTEL YELLOW <b>E4</b> , PINE GREEN <b>EJ</b> , RED <b>ER</b> , SAGE GREEN <b>E9</b> |
| <b>FM-M4</b> | Indoor glossy Metal M4 | + 77 € | BLACK NICKEL <b>DZ</b> , CHAMPAGNE GOLD <b>DG</b> , GOLDEN BRONZE <b>DB</b> , MATT BLACK NICKEL <b>DY</b> , MATT GOLDEN BRONZE <b>DC</b> , PINK GOLD <b>DR</b>   |

**Trip H45**

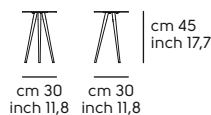

**Trip H50**

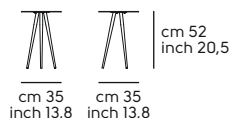

**Trip H60**

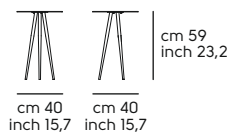



# Complements

# Apelle design Beatriz Sempere

## Desk Apelle

Frame in: metal

| Model   | Code     | Lampshade | Frame | Top     |         | Optional                | Q.ty | boxes | Kg | M <sup>2</sup> |
|---|----------|-----------|-------|---------|---------|-------------------------|------|-------|----|----------------|
|   |          |           |       | LI1     | LI2     |                         |      |       |    |                |
|  Desk Apelle with lighting | TI001136 | CU        | M1    | 1.942 € | 2.104 € | FM-M2<br>FM-M4<br>RV-CT | 1    | 2     | 17 | 0.95           |

| Model   | Code     | -- | -- | Upholstery |       | Optional | Q.ty | boxes | Kg | M <sup>2</sup> |
|---|----------|----|----|------------|-------|----------|------|-------|----|----------------|
|   |          |    |    | CU         | CT    |          |      |       |    |                |
|  Desk Pad APELLE | A1001UHO |    |    | 121 €      | 158 € |          | 1    | 1     | 3  | 0.01           |

### Frame finishes

#### Metal

**M1** WHITE **BB**, BROWN **E6**, SAND **EC**, WHITE PEARL **EF**, GRAPHITE **EG**, BLACK **EN**

### Upholstery finishes

#### Hide

**CU** HIDE

### Top finishes

#### Wood

**LI1** Veneered wood painted BLACK **I04**, Veneered wood painted WHITE **I05**, Veneered wood painted CHERRY RED **I09**, Veneered wood painted DARK BROWN **I26**, Veneered wood painted NATURAL **I40**, Veneered wood painted NATURAL OAK **I52**, Veneered wood painted WHITENED **I60**, Veneered wood painted DESERT **I61**, Veneered wood painted LIGHT GREY **I62**, Veneered wood painted DARK GREY **I63**

**LI2** Veneered wood NATURAL OAK **I22**, Veneered wood FLAMED WALNUT **I24**

### Desk pad finishes

#### Upholstery

**CU** HIDE

**CT** TUSCAN HIDE

### Optionals:

|              | Value                             | Options/notes  |
|--------------|-----------------------------------|--|
| <b>FM-M2</b> | Indoor matt metal M2<br>+ 64 €    | ASH GREY <b>ES</b> , BLUE SAPPHIRE <b>EE</b> , BLUE TURQUOISE <b>EH</b> , BRONZE <b>E2</b> , BULGARO RED <b>FP</b> , CHERRY RED <b>EQ</b> , DARK GREEN <b>EL</b> , FACEPOWDER PINK <b>E8</b> , FANGO <b>E3</b> , GOLDEN YELLOW <b>EO</b> , LIGHT BLUE <b>EO</b> , LIGHT GREY <b>ET</b> , OCEAN BLUE <b>E1</b> , OCHER YELLOW <b>E7</b> , PAPAYA ORANGE <b>EA</b> , PASTEL YELLOW <b>E4</b> , PINE GREEN <b>EJ</b> , RED <b>ER</b> , SAGE GREEN <b>E9</b> |
| <b>FM-M4</b> | Indoor glossy Metal M4<br>+ 178 € | BLACK NICKEL <b>DZ</b>   |
| <b>RV-CT</b> | Tuscan hide<br>+ 217 €            | TUSCAN HIDE  |

### Desk APELLE

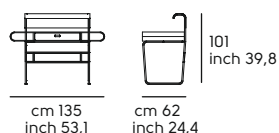

### Desk Pad APELLE

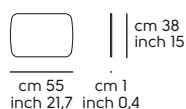

# Apelle design Beatriz Sempere

## Sideboard Apelle

Frame in: metal

| Model  | Code     | Base | Doors and Drawer | Frame   |         | Optional                | G.ty | boxes | Kg | M³   |
|--|----------|------|------------------|---------|---------|-------------------------|------|-------|----|------|
|  |          |      |                  | L11     | L12     |                         |      |       |    |      |
|  | A1001MDO | MI   | CU               | 2.285 € | 2.527 € | FM-M2<br>FM-M4<br>RV-CT | 1    | 1     | 40 | 0.55 |

### Frame finishes

#### Metal

**MI** WHITE **BB**, BROWN **E6**, SAND **EC**, WHITE PEARL **EF**, GRAPHITE **EG**, BLACK **EN**

### Doors-drawer finishes

#### Hide

**CU** HIDE

### Frame finishes

#### Wood

**L11** Veneered wood painted BLACK **I04**, Veneered wood painted WHITE **I05**, Veneered wood painted CHERRY RED **I09**, Veneered wood painted DARK BROWN **I26**, Veneered wood painted NATURAL **I40**, Veneered wood painted NATURAL OAK **I52**, Veneered wood painted WHITENED **I60**, Veneered wood painted DESERT **I61**, Veneered wood painted LIGHT GREY **I62**, Veneered wood painted DARK GREY **I63**

**L12** Veneered wood NATURAL OAK **I22**, Veneered wood FLAMED WALNUT **I24**

### Optionals:

|              |                        | Value   | Options/notes  |
|--------------|------------------------|---------|--|
| <b>FM-M2</b> | Indoor matt metal M2   | + 102 € | ASH GREY <b>ES</b> , BLUE SAPPHIRE <b>EE</b> , BLUE TURQUOISE <b>EH</b> , BRONZE <b>E2</b> , BULGARO RED <b>FP</b> , CHERRY RED <b>EQ</b> , DARK GREEN <b>EL</b> , FACEPOWDER PINK <b>E8</b> , FANGO <b>E3</b> , GOLDEN YELLOW <b>EO</b> , LIGHT BLUE <b>EO</b> , LIGHT GREY <b>ET</b> , OCEAN BLUE <b>E1</b> , OCHER YELLOW <b>E7</b> , PAPAYA ORANGE <b>EA</b> , PASTEL YELLOW <b>E4</b> , PINE GREEN <b>EJ</b> , RED <b>ER</b> , SAGE GREEN <b>E9</b> |
| <b>FM-M4</b> | Indoor glossy Metal M4 | + 153 € | BLACK NICKEL <b>DZ</b>   |
| <b>RV-CT</b> | Tuscan hide            | + 77 €  | TUSCAN HIDE  |

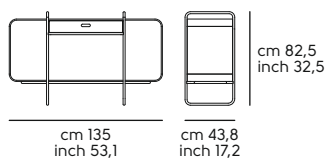

### Sideboard APELLE





# Lea design Paolo Vernier



## Sideboard Lea



Frame in: metal

| Model   | Code     | Base | Frame | Doors and Top |  |  |  |  |  |  |  | Optional | Q.ty | boxes | Kg | M <sup>3</sup> |
|---|----------|------|-------|---------------|--|--|--|--|--|--|--|----------|------|-------|----|----------------|
|   |          |      |       | LM1           |  |  |  |  |  |  |  |          |      |       |    |                |
| <b>Sideboard LEA H73_LC-LC</b><br>   | A1940MD1 | M1   | LM1   | 2.412 €       |  |  |  |  |  |  |  | FM-M4    | 1    | 2     | 74 | 1.52           |
| <b>Sideboard LEA H55_LC-LC</b><br>   | A1941MD1 | M1   | LM1   | 1.902 €       |  |  |  |  |  |  |  | FM-M4    | 1    | 2     | 55 | 0.98           |
| <b>Sideboard LEA H132_LC-LC</b><br> | A1942MD1 | M1   | LM1   | 2.370 €       |  |  |  |  |  |  |  | FM-M4    | 1    | 2     | 84 | 0.53           |

| Model  | Code     | Base | Frame and Top | Doors   |         |         |         |         |         |         |         | Optional | Q.ty  | boxes | Kg | M <sup>3</sup> |      |
|--|----------|------|---------------|---------|---------|---------|---------|---------|---------|---------|---------|----------|-------|-------|----|----------------|------|
|  |          |      |               | TA      | TB      | TC      | TD      | TE      | SF      | SV      | COM     | COL      |       |       |    |                |      |
| <b>Sideboard LEA H73_LC-TS</b><br>  | A1940MD2 | M1   | LM1           | 2.851 € | 2.881 € | 2.938 € | 3.016 € | 3.194 € | 3.007 € | 3.034 € | 2.851 € | 2.938 €  | FM-M4 | 1     | 2  | 76             | 1.52 |
| <b>Sideboard LEA H55_LC-TS</b><br>  | A1941MD2 | M1   | LM1           | 2.158 € | 2.177 € | 2.193 € | 2.323 € | 2.502 € | 2.202 € | 2.214 € | 2.158 € | 2.193 €  | FM-M4 | 1     | 2  | 56             | 0.98 |
| <b>Sideboard LEA H132_LC-TS</b><br> | A1942MD2 | M1   | LM1           | 2.829 € | 2.864 € | 2.923 € | 2.963 € | 3.071 € | 2.972 € | 3.078 € | 2.829 € | 2.923 €  | FM-M4 | 1     | 2  | 85             | 0.53 |

COMPLEMENTS

| Model   | Code     | Base | Frame and Doors | Top     |  |  |  |         |  |  |  | Optional | Q.ty | boxes | Kg | M³   |
|---|----------|------|-----------------|---------|--|--|--|---------|--|--|--|----------|------|-------|----|------|
|   |          |      |                 | GKB     |  |  |  | GMA     |  |  |  |          |      |       |    |      |
| <b>Sideboard LEA H73_KR-LC</b><br>  | A1940MD5 | M1   | LM1             | 3.050 € |  |  |  | 3.127 € |  |  |  | FM-M4    | 1    | 2     | 88 | 1.52 |
| <b>Sideboard LEA H55_KR-LC</b><br>  | A1941MD5 | M1   | LM1             | 2.465 € |  |  |  | 2.527 € |  |  |  | FM-M4    | 1    | 2     | 65 | 0.98 |
| <b>Sideboard LEA H132_KR-LC</b><br> | A1942MD5 | M1   | LM1             | 2.810 € |  |  |  | 2.866 € |  |  |  | FM-M4    | 1    | 2     | 94 | 0.53 |

| Model   | Code     | Base | Frame and Top         | Doors   |         |         |         |         |         |         |         |         | Optional | Q.ty | boxes | Kg | M³   |
|---|----------|------|-----------------------|---------|---------|---------|---------|---------|---------|---------|---------|---------|----------|------|-------|----|------|
|   |          |      |                       | TA      | TB      | TC      | TD      | TE      | SF      | SV      | COM     | COL     |          |      |       |    |      |
| <b>Sideboard LEA H73_KR-TS</b><br>   | A1940MD6 | M1   | LM1<br>- GMA -<br>GKB | 3.565 € | 3.596 € | 3.652 € | 3.732 € | 3.909 € | 3.721 € | 3.749 € | 3.565 € | 3.652 € | FM-M4    | 1    | 2     | 90 | 1.52 |
| <b>Sideboard LEA H55_KR-TS</b><br>  | A1941MD6 | M1   | LM1<br>- GMA -<br>GKB | 2.782 € | 2.801 € | 2.818 € | 2.948 € | 3.126 € | 2.826 € | 2.839 € | 2.782 € | 2.818 € | FM-M4    | 1    | 2     | 66 | 0.98 |
| <b>Sideboard LEA H132_KR-TS</b><br> | A1942MD6 | M1   | LM1<br>- GMA -<br>GKB | 3.325 € | 3.361 € | 3.421 € | 3.459 € | 3.567 € | 3.469 € | 3.576 € | 3.325 € | 3.421 € | FM-M4    | 1    | 2     | 95 | 0.53 |

**Note:**

Sideboard LEA H.73 - Internal shelves in transparent Glass

### Frame finishes

#### Metal

|           |  |
|-----------|--|
| <b>MI</b> | WHITE BB, BROWN E6, SAND EC, WHITE PEARL EF, GRAPHITE EG, BLACK EN |
|-----------|--|

### Frame and doors finishes

#### Wood

|            |  |
|------------|--|
| <b>LMI</b> | Mdf GRAPHITE G02, Mdf BLACK G04, Mdf WHITE G05, Mdf SAND G07 |
|------------|--|

### Top finishes

#### Crystal Ceramic and Ceramic

|            |  |
|------------|--|
| <b>GKB</b> | WHITE CALCE K24, BLACK CALCE K25, TORTORA CALCE K26, PIASENTINA STONE TAUPE Materica K55, TERRACOTTA Matt K90, MATT GREEN K91  |
| <b>GMA</b> | MARBLE CALACATTA GLOSSY WHITE K32, BLACK GREEK MARBLE K33, MARBLE GLOSSY NOIR DESIR K35, MARBLE CALACATTA MATT WHITE K42, MARBLE MATT NOIR DESIR K45, MARBLE MATT GREEN TINOS K46, MARBLE STATUARIO WHITE MATT K47, MARBLE CALACAT BLACK Bush Hammered K50 |

### Door finishes

#### Upholstery

|           |  |           |   |
|-----------|--|-----------|---|
| <b>TA</b> | FAUX LEATHER Secret, FABRIC Mirage, FABRIC Cotton Club, FABRIC Renewed Loop  | <b>TB</b> | FAUX LEATHER Vintage, FABRIC Fenix Wool, FABRIC Visual, FABRIC Manhattan, FABRIC Novabuk, FABRIC Network, FABRIC Gyre |
| <b>TC</b> | VELVET SUPERB, FABRIC Second, FABRIC Main Line Flax, FABRIC Oceanic, FABRIC Jumper, FABRIC Flame, FABRIC Ouche, FABRIC Plain, FABRIC Gemma, FABRIC Caltagirone 114 | <b>TD</b> | FABRIC Yoredale, FABRIC Remix 3   |
| <b>TE</b> | FABRIC Uniform Melange   | <b>SF</b> | LEATHER Fiore   |
| <b>SV</b> | LEATHER Vintage  |           |   |

#### Optionals:

|              |                        | Value   | Options/notes   |
|--------------|------------------------|---------|-----------------|
| <b>FM-M4</b> | Indoor glossy Metal M4 | + 230 € | BLACK NICKEL DZ |

#### Sideboard LEA H73

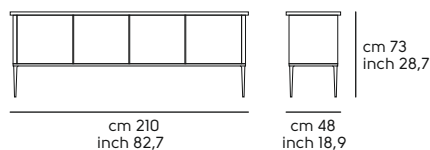

#### Sideboard LEA H55

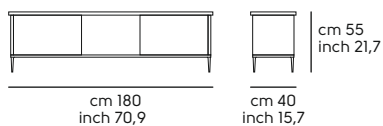



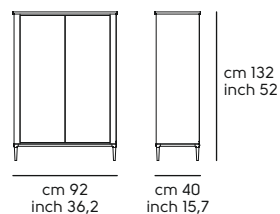

#### Sideboard LEA H132



# Apelle design Beatriz Sempere

## Bookcase Apelle

Frame in: metal

| Model  | Code     | -- | Frame | Shelves |         | Optional       | G.ty | boxes | Kg | M <sup>3</sup> |
|--|----------|----|-------|---------|---------|----------------|------|-------|----|----------------|
|  |          |    |       | L11     | L12     |                |      |       |    |                |
|    | A1001M41 |    | M1    | 1.018 € | 1.222 € | FM-M2<br>FM-M4 | 1    | 2     | 6  | 0.30           |
|    | A1001M42 |    | M1    | 1.950 € | 2.361 € | FM-M2<br>FM-M4 | 1    | 3     | 9  | 0.46           |
|  | A1001M43 |    | M1    | 2.875 € | 3.490 € | FM-M2<br>FM-M4 | 1    | 4     | 12 | 0.70           |
|  | A1001M44 |    | M1    | 3.778 € | 4.599 € | FM-M2<br>FM-M4 | 1    | 5     | 15 | 0.95           |

### Frame finishes

#### Metal

|           |   |
|-----------|---|
| <b>M1</b> | WHITE <b>BB</b> , BROWN <b>E6</b> , SAND <b>EC</b> , WHITE PEARL <b>EF</b> , GRAPHITE <b>EG</b> , BLACK <b>EN</b> |
|-----------|---|

### Shell finishes

#### Wood

|            |  |
|------------|--|
| <b>L11</b> | Veneered wood painted BLACK <b>I04</b> , Veneered wood painted WHITE <b>I05</b> , Veneered wood painted CHERRY RED <b>I09</b> , Veneered wood painted DARK BROWN <b>I26</b> , Veneered wood painted NATURAL <b>I40</b> , Veneered wood painted NATURAL OAK <b>I52</b> , Veneered wood painted WHITENED <b>I60</b> , Veneered wood painted DESERT <b>I61</b> , Veneered wood painted LIGHT GREY <b>I62</b> , Veneered wood painted DARK GREY <b>I63</b> |
| <b>L12</b> | Veneered wood NATURAL OAK <b>I22</b> , Veneered wood FLAMED WALNUT <b>I24</b>  |

### Optionals:

|              |                        | Value   | Options/notes  |
|--------------|------------------------|---------|--|
| <b>FM-M2</b> | Indoor matt metal M2   | + 102 € | ASH GREY <b>ES</b> , BLUE SAPPHIRE <b>EE</b> , BLUE TURQUOISE <b>EH</b> , BRONZE <b>E2</b> , BULGARO RED <b>FP</b> , CHERRY RED <b>EQ</b> , DARK GREEN <b>EL</b> , FACEPOWDER PINK <b>E8</b> , FANGO <b>E3</b> , GOLDEN YELLOW <b>EO</b> , LIGHT BLUE <b>EO</b> , LIGHT GREY <b>ET</b> , OCEAN BLUE <b>E1</b> , OCHER YELLOW <b>E7</b> , PAPAYA ORANGE <b>EA</b> , PASTEL YELLOW <b>E4</b> , PINE GREEN <b>EJ</b> , RED <b>ER</b> , SAGE GREEN <b>E9</b> |
| <b>FM-M4</b> | Indoor glossy Metal M4 | + 153 € | BLACK NICKEL <b>DZ</b>   |

| Model   | Code     | -- | -- | Upholstery |       | Optional | Q.ty | boxes | Kg | M <sup>3</sup> |
|---|----------|----|----|------------|-------|----------|------|-------|----|----------------|
|   |          |    |    | CU         | CT    |          |      |       |    |                |
| <b>Bookcase drawer APELLE 40</b>  |          |    |    |            |       |          |      |       |    |                |
|  | A1001BC4 |    |    | 153 €      | 217 € |          | 1    | 1     | 3  | 0.04           |

### Drawer finishes

### Upholstery

|           |      |           |             |
|-----------|------|-----------|-------------|
| <b>CU</b> | HIDE | <b>CT</b> | TUSCAN HIDE |
|-----------|------|-----------|-------------|

#### Bookcase APELLE 1 P.40

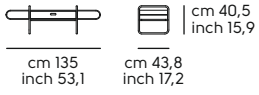

#### Bookcase APELLE 2 P.40

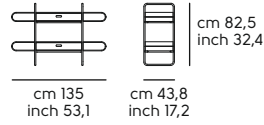

#### Bookcase APELLE 3 P.40

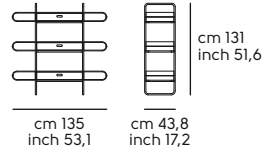

#### Bookcase APELLE 4 P.40

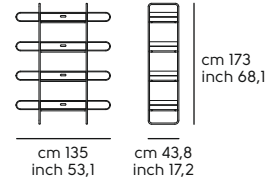



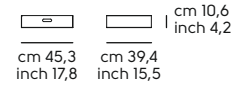

#### Drawer APELLE 40





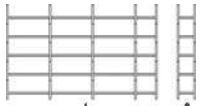
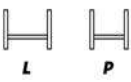
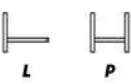
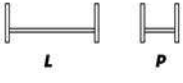

# Siena design Balutto Associati

## Bookcase Siena

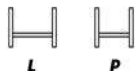
Frame in: wood

| Model   | Code       | Type  | Frame | Shelves | Optional | Q.ty | boxes | Kg   | M <sup>3</sup> |
|---|------------|-------|-------|---------|----------|------|-------|------|----------------|
| <b>M1</b>   |            |       |       |         |          |      |       |      |                |
| <b>Composition "A"_MT</b><br>      | A2030M0A   | A     | LFI   | 961 €   |          | 1    | 4     | 14   | 0.04           |
| <b>Composition "B"_MT</b><br>      | A2030M0B   | B     | LFI   | 1.179 € |          | 1    | 4     | 20.5 | 0.04           |
| <b>Composition "C"_MT</b><br>       | A2030M0C   | C     | LFI   | 4.958 € |          | 1    | 20    | 88   | 0.20           |
| <b>M1</b>   |            |       |       |         |          |      |       |      |                |
| <b>End Module 40_MT</b><br>      | A2030E40M0 | TC_40 | LFI   | 239 €   |          | 1    | 1     | 3.5  | 0.01           |
| <b>Internal Module 40_MT</b><br> | A2030I40M0 | IN_40 | LFI   | 198 €   |          | 1    | 1     | 3.1  | 0.01           |
| <b>End Module 80_MT</b><br>       | A2030E80M0 | TC_80 | LFI   | 295 €   |          | 1    | 1     | 5.1  | 0.01           |
| <b>Internal Module 80_MT</b><br>  | A2030I80M0 | IN_80 | LFI   | 253 €   |          | 1    | 1     | 4.7  | 0.01           |

|                              |   |            |       | GVA | GVB   | GVE   |       |   |   |     |      |
|------------------------------|---|------------|-------|-----|-------|-------|-------|---|---|-----|------|
| <b>End Module 40_VT</b>      |  | A2030E40V0 | TC_40 | LF1 | 243 € | 240 € | 256 € | 1 | 1 | 3.6 | 0.01 |
| <b>Internal Module 40_VT</b> |  | A2030I40V0 | IN_40 | LF1 | 200 € | 198 € | 213 € | 1 | 1 | 3.2 | 0.01 |
| <b>End Module 80_VT</b>      |  | A2030E80V0 | TC_80 | LF1 | 290 € | 282 € | 296 € | 1 | 1 | 5.2 | 0.01 |
| <b>Internal Module 80_VT</b> |  | A2030I80V0 | IN_80 | LF1 | 249 € | 241 € | 254 € | 1 | 1 | 4.8 | 0.01 |

**Frame finishes**

**Wood**

**LF1**

Ash wood stained BLACK **F04**, Ash wood stained WHITE **F05**, Ash wood stained CHERRY RED **F09**, Ash wood stained FLAMED WALNUT **F24**, Ash wood stained DARK BROWN **F26**, Ash wood stained NATURAL **F40**, Ash wood stained NATURAL OAK **F52**, Ash wood stained WHITENED **F60**, Ash wood stained DESERT **F61**, Ash wood stained LIGHT GREY **F62**, Ash wood stained DARK GREY **F63**

**Shell finishes**

**Metal**

**MI**

WHITE **BB**, BROWN **E6**, SAND **EC**, WHITE PEARL **EF**, GRAPHITE **EG**, BLACK **EN**

**Shell finishes**

**Glossy Glass**

**GVA**

TRANSPARENT **J02**

**GVE**

GLOSSY FUME' **J05**

**GVB**

GLOSSY SAND **J11**, EXTRA CLEAR GLOSSY WHITE **J21**, EXTRA CLEAR GLOSSY CHERRY RED **J25**, EXTRA CLEAR GLOSSY BLUE SAPPHIRE **J26**, EXTRA CLEAR GLOSSY BLUE TURQUOISE **J27**

**Module TC\_40**

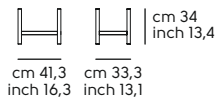

**Module IN\_40**

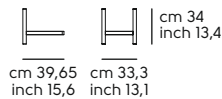

**Module TC\_80**

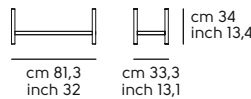

**Module IN\_80**

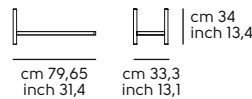

**Composition "A"**

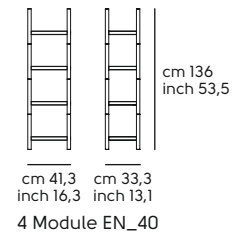

**Composition "B"**

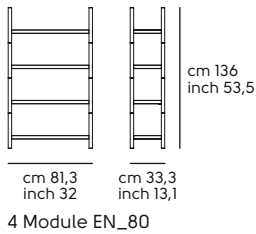

**Composition "C"**

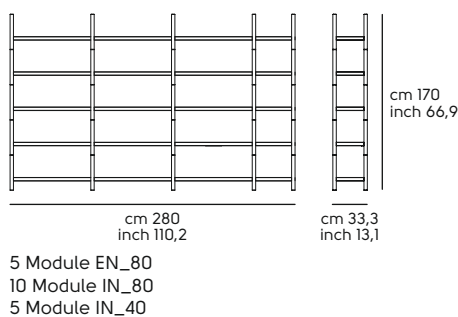

# Suite design AtelierNanni

## Bookcase Suite

Frame in: wood or metal

| Model  | Code    | Support | Frame | Shelves |         | Optional | G.ty | boxes | Kg | M <sup>3</sup> |
|--|---------|---------|-------|---------|---------|----------|------|-------|----|----------------|
|  |         |         |       | M1      | M2      |          |      |       |    |                |
|  <b>Bookcase SUITE</b> | A1750L0 | M1      | LFI   | 1.760 € | 1.928 € | FM-M2    | 1    | 1     | 70 | 1.10           |

### Finishes support

#### Metal

|           |   |
|-----------|---|
| <b>M1</b> | WHITE <b>BB</b> , BROWN <b>E6</b> , SAND <b>EC</b> , WHITE PEARL <b>EF</b> , GRAPHITE <b>EG</b> , BLACK <b>EN</b> |
|-----------|---|

### Frame finishes

#### Wood

|            |  |
|------------|--|
| <b>LFI</b> | Ash wood stained BLACK <b>F04</b> , Ash wood stained WHITE <b>F05</b> , Ash wood stained CHERRY RED <b>F09</b> , Ash wood stained FLAMED WALNUT <b>F24</b> , Ash wood stained DARK BROWN <b>F26</b> , Ash wood stained NATURAL <b>F40</b> , Ash wood stained NATURAL OAK <b>F52</b> , Ash wood stained WHITENED <b>F60</b> , Ash wood stained DESERT <b>F61</b> , Ash wood stained LIGHT GREY <b>F62</b> , Ash wood stained DARK GREY <b>F63</b> |
|------------|--|

### Shell finishes

#### Metal

|           |   |
|-----------|---|
| <b>M1</b> | WHITE <b>BB</b> , BROWN <b>E6</b> , SAND <b>EC</b> , WHITE PEARL <b>EF</b> , GRAPHITE <b>EG</b> , BLACK <b>EN</b> |
|-----------|---|

|           |  |
|-----------|--|
| <b>M2</b> | LIGHT BLUE <b>E0</b> , OCEAN BLUE <b>E1</b> , BRONZE <b>E2</b> , FANGO <b>E3</b> , PASTEL YELLOW <b>E4</b> , OCHER YELLOW <b>E7</b> , FACEPOWDER PINK <b>E8</b> , SAGE GREEN <b>E9</b> , PAPAYA ORANGE <b>EA</b> , BLUE SAPPHIRE <b>EE</b> , BLUE TURQUOISE <b>EH</b> , PINE GREEN <b>EJ</b> , DARK GREEN <b>EL</b> , GOLDEN YELLOW <b>EO</b> , CHERRY RED <b>EQ</b> , RED <b>ER</b> , ASH GREY <b>ES</b> , LIGHT GREY <b>ET</b> , BULGARO RED <b>FP</b> |
|-----------|--|

### Optionals:

|              | Value                | Options/notes   |
|--------------|----------------------|---|
| <b>FM-M2</b> | Indoor matt metal M2 | + 102 €<br>ASH GREY <b>ES</b> , BLUE SAPPHIRE <b>EE</b> , BLUE TURQUOISE <b>EH</b> , BRONZE <b>E2</b> , BULGARO RED <b>FP</b> , CHERRY RED <b>EQ</b> , DARK GREEN <b>EL</b> , FACEPOWDER PINK <b>E8</b> , FANGO <b>E3</b> , GOLDEN YELLOW <b>EO</b> , LIGHT BLUE <b>E0</b> , LIGHT GREY <b>ET</b> , OCEAN BLUE <b>E1</b> , OCHER YELLOW <b>E7</b> , PAPAYA ORANGE <b>EA</b> , PASTEL YELLOW <b>E4</b> , PINE GREEN <b>EJ</b> , RED <b>ER</b> , SAGE GREEN <b>E9</b> |

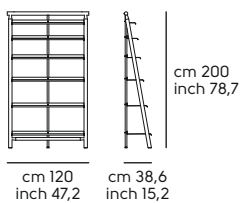

### Bookcase SUITE



# Hoodi design Roberto Paoli



## Consolle Hoodi

Frame in: metal

| Model   | Code     | -- | -- | Frame and Top |       | Optional | Q.ty | boxes | Kg   | M <sup>2</sup> |
|---|----------|----|----|---------------|-------|----------|------|-------|------|----------------|
|   |          |    |    | M1            | M2    |          |      |       |      |                |
| <b>Consolle HOODI H65 MT</b><br> | T2060CNS |    |    | 244 €         | 294 € |          | 1    | 1     | 9.5  | 0.18           |
| <b>Consolle HOODI H75 MT</b><br> | T2060CNM |    |    | 276 €         | 327 € |          | 1    | 1     | 11.5 | 0.26           |

## Consolle Hoodi Hide

Frame in: metal

| Model   | Code     | -- | Frame | Top   |       | Optional       | Q.ty | boxes | Kg   | M <sup>2</sup> |
|---|----------|----|-------|-------|-------|----------------|------|-------|------|----------------|
|   |          |    |       | CU    | CT    |                |      |       |      |                |
| <b>Consolle HOODI H65 CU</b><br> | T2062CNS |    | M1    | 293 € | 331 € | FM-M2<br>FM-M4 | 1    | 1     | 10.5 | 0.18           |
| <b>Consolle HOODI H75 CU</b><br> | T2062CNM |    | M1    | 341 € | 335 € | FM-M2<br>FM-M4 | 1    | 1     | 12.5 | 0.26           |

### Frame and Top finishes

#### Metal

|           |   |           |  |
|-----------|---|-----------|--|
| <b>M1</b> | WHITE <b>BB</b> , BROWN <b>E6</b> , SAND <b>EC</b> , WHITE PEARL <b>EF</b> , GRAPHITE <b>EG</b> , BLACK <b>EN</b> | <b>M2</b> | LIGHT BLUE <b>E0</b> , OCEAN BLUE <b>E1</b> , BRONZE <b>E2</b> , FANGO <b>E3</b> , PASTEL YELLOW <b>E4</b> , OCHER YELLOW <b>E7</b> , FACEPOWDER PINK <b>E8</b> , SAGE GREEN <b>E9</b> , PAPAYA ORANGE <b>EA</b> , BLUE SAPPHIRE <b>EE</b> , BLUE TURQUOISE <b>EH</b> , PINE GREEN <b>EJ</b> , DARK GREEN <b>EL</b> , GOLDEN YELLOW <b>EO</b> , CHERRY RED <b>EQ</b> , RED <b>ER</b> , ASH GREY <b>ES</b> , LIGHT GREY <b>ET</b> , BULGARO RED <b>FP</b> |
|-----------|---|-----------|--|

### Top finishes

#### Hide

|           |      |           |             |
|-----------|------|-----------|-------------|
| <b>CU</b> | HIDE | <b>CT</b> | TUSCAN HIDE |
|-----------|------|-----------|-------------|

| Optionals:   |                        | Value   | Options/notes  |
|--------------|------------------------|---------|--|
| <b>FM-M2</b> | Indoor matt metal M2   | + 57 €  | ASH GREY <b>ES</b> , BLUE SAPPHIRE <b>EE</b> , BLUE TURQUOISE <b>EH</b> , BRONZE <b>E2</b> , BULGARO RED <b>FP</b> , CHERRY RED <b>EQ</b> , DARK GREEN <b>EL</b> , FACEPOWDER PINK <b>E8</b> , FANGO <b>E3</b> , GOLDEN YELLOW <b>EO</b> , LIGHT BLUE <b>EO</b> , LIGHT GREY <b>ET</b> , OCEAN BLUE <b>EI</b> , OCHER YELLOW <b>E7</b> , PAPAYA ORANGE <b>EA</b> , PASTEL YELLOW <b>E4</b> , PINE GREEN <b>EJ</b> , RED <b>ER</b> , SAGE GREEN <b>E9</b> |
| <b>FM-M4</b> | Indoor glossy Metal M4 | + 122 € | BLACK NICKEL <b>DZ</b> , CHAMPAGNE GOLD <b>DG</b> , GOLDEN BRONZE <b>DB</b> , MATT BLACK NICKEL <b>DY</b> , MATT GOLDEN BRONZE <b>DC</b> , PINK GOLD <b>DR</b>   |

#### Hoodi H65

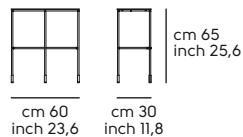

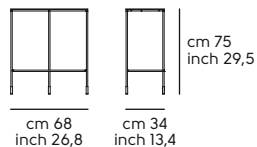

#### Hoodi H75



# Hoodi design Roberto Paoli

## Shelf Hoodi

Frame in: metal

| Model  | Code      | -- | -- | Frame |       | Optional | Q.ty | boxes | Kg  | M³   |
|--|-----------|----|----|-------|-------|----------|------|-------|-----|------|
|  |           |    |    | M1    | M2    |          |      |       |     |      |
| <b>Shelf HOODI S</b><br> | A2060MES0 |    |    | 88 €  | 130 € |          | 1    | 1     | 3.2 | 0.02 |
| <b>Shelf HOODI M</b><br> | A2060MEM0 |    |    | 114 € | 156 € |          | 1    | 1     | 4.8 | 0.03 |
| <b>Shelf HOODI L</b><br> | A2060MELO |    |    | 130 € | 172 € |          | 1    | 1     | 6.0 | 0.05 |

### Frame finishes

#### Metal

|           |   |           |   |
|-----------|---|-----------|---|
| <b>M1</b> | WHITE <b>BB</b> , BROWN <b>E6</b> , SAND <b>EC</b> , WHITE PEARL <b>EF</b> , GRAPHITE <b>EG</b> , BLACK <b>EN</b> | <b>M2</b> | LIGHT BLUE <b>EO</b> , OCEAN BLUE <b>EI</b> , FANGO <b>E3</b> , PASTEL YELLOW <b>E4</b> , OCHER YELLOW <b>E7</b> , FACEPOWDER PINK <b>E8</b> , SAGE GREEN <b>E9</b> , PAPAYA ORANGE <b>EA</b> , BLUE SAPPHIRE <b>EE</b> , BLUE TURQUOISE <b>EH</b> , PINE GREEN <b>EJ</b> , DARK GREEN <b>EL</b> , GOLDEN YELLOW <b>EO</b> , CHERRY RED <b>EQ</b> , RED <b>ER</b> , ASH GREY <b>ES</b> , LIGHT GREY <b>ET</b> , BRONZE <b>EZ</b> + TRANSP., BULGARO RED <b>FP</b> |
|-----------|---|-----------|---|

#### Hoodi S

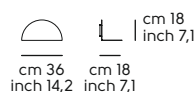

#### Hoodi M

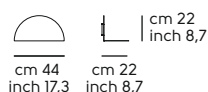

#### Hoodi L

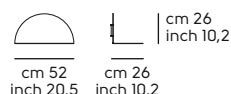

# Apelle design Beatriz Sempere

## Coat Hanger Apelle

Frame in: metal

| Model   | Code    | -- | Frame | Upholstery |       | Optional       | G.ty | boxes | Kg | M <sup>3</sup> |
|---|---------|----|-------|------------|-------|----------------|------|-------|----|----------------|
|   |         |    |       | CK         | CT    |                |      |       |    |                |
|  Coat Hanger APELLE TREE | A1000A0 |    | M1    | 278 €      | 298 € | FM-M2<br>FM-M4 | 1    | 2     | 9  | 0.06           |

### Note:

Hide upholstered base only for FM-M4 finish

### Frame finishes

#### Metal

**M1** WHITE **BB**, BROWN **E6**, SAND **EC**, WHITE PEARL **EF**, GRAPHITE **EG**, BLACK **EN**

### Upholstery finishes

#### Hide

**CK** HIDE\_TK

**CT** TUSCAN HIDE

### Optionals:

|              |                        | Value   | Options/notes  |
|--------------|------------------------|---------|--|
| <b>FM-M2</b> | Indoor matt metal M2   | + 77 €  | ASH GREY <b>ES</b> , BLUE SAPPHIRE <b>EE</b> , BLUE TURQUOISE <b>EH</b> , BRONZE <b>E2</b> , BULGARO RED <b>FP</b> , CHERRY RED <b>EQ</b> , DARK GREEN <b>EL</b> , FACEPOWDER PINK <b>E8</b> , FANGO <b>E3</b> , GOLDEN YELLOW <b>EO</b> , LIGHT BLUE <b>EO</b> , LIGHT GREY <b>ET</b> , OCEAN BLUE <b>E1</b> , OCHER YELLOW <b>E7</b> , PAPAYA ORANGE <b>EA</b> , PASTEL YELLOW <b>E4</b> , PINE GREEN <b>EJ</b> , RED <b>ER</b> , SAGE GREEN <b>E9</b> |
| <b>FM-M4</b> | Indoor glossy Metal M4 | + 128 € | BLACK NICKEL <b>DZ</b> , CHAMPAGNE GOLD <b>DG</b> , GOLDEN BRONZE <b>DB</b> , MATT BLACK NICKEL <b>DY</b> , MATT GOLDEN BRONZE <b>DC</b> , PINK GOLD <b>DR</b>   |

### Apelle TREE

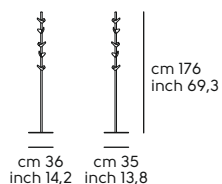

# Guapa design Franco Poli

## Coat Hanger Guapa

Frame in: metal

| Model  | Code    | -- | Frame | Upholstery |       | Optional       | G.ty | boxes | Kg  | M <sup>3</sup> |
|--|---------|----|-------|------------|-------|----------------|------|-------|-----|----------------|
|  |         |    |       | CK         | CT    |                |      |       |     |                |
|  Coat Hanger GUAPA | A1150A0 |    | MI    | 381 €      | 459 € | FM-M2<br>FM-M4 | 1    | 1     | 7.9 | 0.25           |

### Frame finishes

#### Metal

|           |   |
|-----------|---|
| <b>MI</b> | WHITE <b>BB</b> , BROWN <b>E6</b> , SAND <b>EC</b> , WHITE PEARL <b>EF</b> , GRAPHITE <b>EG</b> , BLACK <b>EN</b> |
|-----------|---|

### Upholstery finishes

#### Hide

|           |             |
|-----------|-------------|
| <b>CK</b> | HIDE_TK     |
| <b>CT</b> | TUSCAN HIDE |

### Optionals:

|              |                        | Value   | Options/notes  |
|--------------|------------------------|---------|--|
| <b>FM-M2</b> | Indoor matt metal M2   | + 77 €  | ASH GREY <b>ES</b> , BLUE SAPPHIRE <b>EE</b> , BLUE TURQUOISE <b>EH</b> , BRONZE <b>E2</b> , CHERRY RED <b>EQ</b> , DARK GREEN <b>EL</b> , FACEPOWDER PINK <b>E8</b> , FANGO <b>E3</b> , GOLDEN YELLOW <b>EO</b> , LIGHT BLUE <b>EO</b> , LIGHT GREY <b>ET</b> , OCEAN BLUE <b>E1</b> , OCHER YELLOW <b>E7</b> , PAPAYA ORANGE <b>EA</b> , PASTEL YELLOW <b>E4</b> , PINE GREEN <b>EJ</b> , RED <b>ER</b> , SAGE GREEN <b>E9</b> |
| <b>FM-M4</b> | Indoor glossy Metal M4 | + 128 € | BLACK NICKEL <b>DZ</b> , CHAMPAGNE GOLD <b>DG</b> , GOLDEN BRONZE <b>DB</b> , MATT BLACK NICKEL <b>DY</b> , MATT GOLDEN BRONZE <b>DC</b> , PINK GOLD <b>DR</b>   |

### Guapa

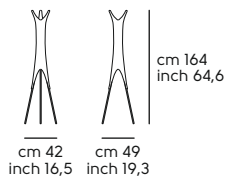

# Pippi design Roberto Paoli

## Coat Hanger Pippi - Completely upholstered in fabric

Frame in: metal upholstered

| Model  | Code    | -- | feet | Upholstery |       | Optional       | G.ty | boxes | Kg | M <sup>3</sup> |
|--|---------|----|------|------------|-------|----------------|------|-------|----|----------------|
|  |         |    |      | TB         | TE    |                |      |       |    |                |
| <br>Coat Hanger PIPPI | A1950A0 |    | M1   | 399 €      | 445 € | FM-M2<br>FM-M4 | 1    | 1     | 7  | 0.33           |

### Finishes Metal Feet

#### Metal

**MI** WHITE **BB**, BROWN **E6**, SAND **EC**, WHITE PEARL **EF**, GRAPHITE **EG**, BLACK **EN**

### Upholstery finishes

#### Fabric

**TB** FABRIC **Fenix Wool**, FABRIC **Visual**, FABRIC **Network**

**TE** FABRIC **Uniform Melange**

### Optionals:





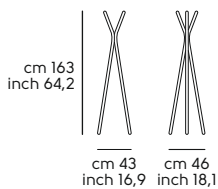

|              |                        | Value  | Options/notes  |
|--------------|------------------------|--------|--|
| <b>FM-M2</b> | Indoor matt metal M2   | + 26 € | ASH GREY <b>ES</b> , BLUE SAPPHIRE <b>EE</b> , BLUE TURQUOISE <b>EH</b> , BRONZE <b>E2</b> , BULGARO RED <b>FP</b> , CHERRY RED <b>EQ</b> , DARK GREEN <b>EL</b> , FACEPOWDER PINK <b>E8</b> , FANGO <b>E3</b> , GOLDEN YELLOW <b>EO</b> , LIGHT BLUE <b>EO</b> , LIGHT GREY <b>ET</b> , OCEAN BLUE <b>EI</b> , OCHER YELLOW <b>E7</b> , PAPAYA ORANGE <b>EA</b> , PASTEL YELLOW <b>E4</b> , PINE GREEN <b>EJ</b> , RED <b>ER</b> , SAGE GREEN <b>E9</b> |
| <b>FM-M4</b> | Indoor glossy Metal M4 | + 68 € | BLACK NICKEL <b>DZ</b> , CHAMPAGNE GOLD <b>DG</b> , GOLDEN BRONZE <b>DB</b> , MATT BLACK NICKEL <b>DY</b> , MATT GOLDEN BRONZE <b>DC</b> , PINK GOLD <b>DR</b>   |

### Pippi









# Bold design Andrea Lucatello

## Mirror Bold Bronze - Glass Bronze

| Model   | Code    | Type | Mirror Frame Bronz |  |  |  |  |  |  |  |  |  | Optional | Q.ty<br> | boxes<br> | Kg<br> | M <sup>2</sup><br> |
|---|---------|------|--------------------|--|--|--|--|--|--|--|--|--|----------|---|--|---|---|
|   |         |      | ZC                 |  |  |  |  |  |  |  |  |  |          |   |  |   |   |
| <b>Mirror BOLD H120</b><br> | A2250S0 | H120 | 1.078 €            |  |  |  |  |  |  |  |  |  |          | 1   | 1  | 33.5  | 0.15  |
| <b>Mirror BOLD H200</b><br> | A2250S1 | H200 | 1.262 €            |  |  |  |  |  |  |  |  |  |          | 1   | 1  | 44  | 0.18  |

## Mirror Bold Upholstery - Glass Fumè

| Model   | Code    | Type | Mirror Frame Upholstered |         |         |         |         |         |         |         |         |  | Optional | Q.ty<br> | boxes<br> | Kg<br> | M <sup>2</sup><br> |
|---|---------|------|--------------------------|---------|---------|---------|---------|---------|---------|---------|---------|--|----------|---|--|---|---|
|   |         |      | TA                       | TB      | TC      | TD      | TE      | SF      | SV      | COM     | COL     |  |          |   |  |   |   |
| <b>Mirror BOLD H120</b><br> | A2250T0 | H120 | 1.223 €                  | 1.264 € | 1.330 € | 1.375 € | 1.499 € | 1.082 € | 976 €   | 1.223 € | 1.330 € |  |          | 1   | 1  | 34.5  | 0.15  |
| <b>Mirror BOLD H200</b><br> | A2250T1 | H200 | 1.398 €                  | 1.450 € | 1.536 € | 1.594 € | 1.753 € | 1.546 € | 1.673 € | 1.398 € | 1.536 € |  |          | 1   | 1  | 45  | 0.18  |

**Upholstery**

|           |   |           |  |
|-----------|---|-----------|--|
| <b>TA</b> | FAUX LEATHER <b>Secret</b> , FABRIC <b>Mirage</b> , FABRIC <b>Cotton Club</b> , FABRIC <b>Renewed Loop</b>  | <b>TB</b> | FAUX LEATHER <b>Vintage</b> , FABRIC <b>Fenix Wool</b> , FABRIC <b>Visual</b> , FABRIC <b>Manhattan</b> , FABRIC <b>Novabuk</b> , FABRIC <b>Network</b> , FABRIC <b>Gyre</b> |
| <b>TC</b> | VELVET SUPERB, FABRIC <b>Second</b> , FABRIC <b>Main Line Flax</b> , FABRIC <b>Oceanic</b> , FABRIC <b>Jumper</b> , FABRIC <b>Flame</b> , FABRIC <b>Ouche</b> , FABRIC <b>Plain</b> , FABRIC <b>Gemma</b> , FABRIC <b>Caltagirone 114</b> | <b>TD</b> | FABRIC <b>Yoredale</b> , FABRIC <b>Remix 3</b>   |
| <b>TE</b> | FABRIC <b>Uniform Melange</b>   | <b>SF</b> | LEATHER <b>Fiore</b>   |
| <b>SV</b> | LEATHER <b>Vintage</b>  |           |  |

**Bold H120**

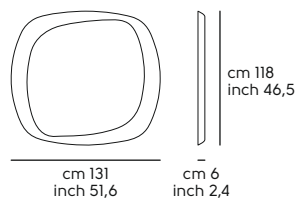

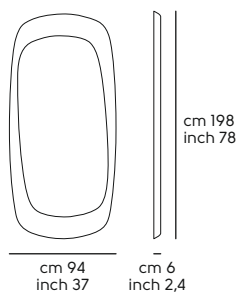

**Bold H200**



# Hoodi design Roberto Paoli

## Mirror Hoodi

| Model  | Code     | Type | Mirror | Optional | G.ty | boxes | Kg  | M <sup>2</sup> |
|--|----------|------|--------|----------|------|-------|-----|----------------|
|  |          |      | SPO    |          |      |       |     |                |
| <b>Mirror HOODI S</b><br>  | A2060SS0 | S    | 254 €  |          | 1    | 1     | 3   | 0.02           |
| <b>Mirror HOODI M</b><br>  | A2060SM0 | M    | 266 €  |          | 1    | 1     | 3.5 | 0.03           |
| <b>Mirror HOODI L</b><br> | A2060SL0 | L    | 286 €  |          | 1    | 1     | 4.5 | 0.03           |

### Finishes

#### Mirror

**SPO** SILVER AA, BRONZE BR, FUME' FU

#### Hoodi S

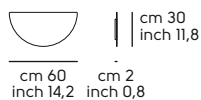

#### Hoodi M

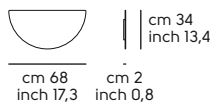

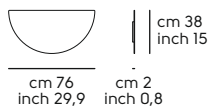

#### Hoodi L



# Peek design Studio Pastina

## Mirror Peek

| Model   | Code    | Type |  | Mirror with smoked insert | Optional | G.ty | boxes | Kg | M <sup>2</sup> |
|---|---------|------|--|---------------------------|----------|------|-------|----|----------------|
|   |         |      |  |                           | ZC       |      |       |    |                |
| <b>Mirror PEEK S</b>  |         |      |  |                           |          |      |       |    |                |
|  | A1990SP | S    |  | 499 €                     |          | 1    | 1     | 10 | 0.035          |
| <b>Mirror PEEK M</b>  |         |      |  |                           |          |      |       |    |                |
|  | A1990SM | M    |  | 587 €                     |          | 1    | 1     | 18 | 0.060          |
| <b>Mirror PEEK L</b>  |         |      |  |                           |          |      |       |    |                |
|  | A1990SG | L    |  | 823 €                     |          | 1    | 1     | 35 | 0.120          |

### Peek S

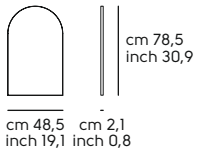

### Peek M

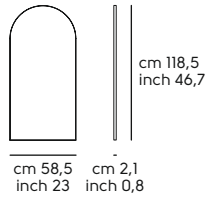

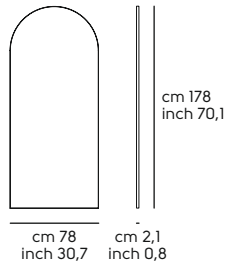

### Peek L



# Spot design Nicola Bonriposi

## Mirror Spot

| Model   | Code    | Type | Mirror | Optional | G.ty | boxes | Kg | M <sup>2</sup> |
|---|---------|------|--------|----------|------|-------|----|----------------|
|   |         |      | ZC     |          |      |       |    |                |
| <b>Mirror SPOT S</b>  |         |      |        |          |      |       |    |                |
|   | A2080SS | S    | 598 €  |          | 1    | 1     | 15 | 0.05           |
| <b>Mirror SPOT M</b>  |         |      |        |          |      |       |    |                |
|   | A2080SM | M    | 881 €  |          | 1    | 1     | 28 | 0.09           |
| <b>Mirror SPOT L</b>  |         |      |        |          |      |       |    |                |
|  | A2080SL | L    | 939 €  |          | 1    | 1     | 30 | 0.10           |

### Spot S

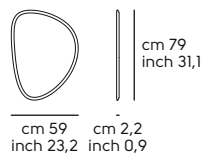

### Spot M

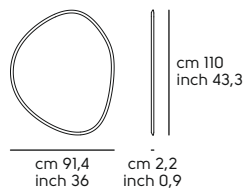

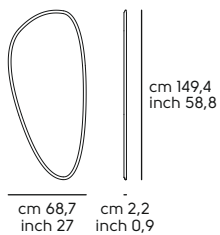

### Spot L



# Bolle design Paola Navone

## Lamp Bolle

Frame in: metal - Base in concrete

| Model  | Code    | Type | -- | Frame |         | Optional | G.ty | boxes | Kg   | M <sup>3</sup> |
|--|---------|------|----|-------|---------|----------|------|-------|------|----------------|
|  |         |      |    | M1    | M2      |          |      |       |      |                |
| <b>Suspension BOLLE S</b><br> | A2200L1 | S    |    | 682 € | 799 €   |          | 1    | 1     | 7    | 0.09           |
| <b>Suspension BOLLE L</b><br> | A2200L2 | L    |    | 946 € | 1.071 € |          | 1    | 1     | 11.5 | 0.39           |
| <b>Floor lamp BOLLE</b><br>  | A2200LT | F    |    | 902 € | 1.018 € |          | 1    | 1     | 27   | 0.36           |

### Note:

Bulb INCLUDED - Cable in Black Fabric - Base in concrete

### Frame finishes

#### Metal

**M1** WHITE **BB**, BROWN **E6**, SAND **EC**, WHITE PEARL **EF**, GRAPHITE **EG**, BLACK **EN**

**M2** LIGHT BLUE **E0**, OCEAN BLUE **E1**, BRONZE **E2**, FANGO **E3**, PASTEL YELLOW **E4**, OCHER YELLOW **E7**, FACEPOWDER PINK **E8**, SAGE GREEN **E9**, PAPAYA ORANGE **EA**, BLUE SAPPHIRE **EE**, BLUE TURQUOISE **EH**, PINE GREEN **EJ**, DARK GREEN **EL**, GOLDEN YELLOW **EO**, CHERRY RED **EQ**, RED **ER**, ASH GREY **ES**, LIGHT GREY **ET**, BULGARO RED **FP**

#### Bolle S

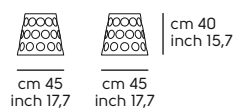

#### Bolle L

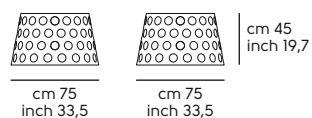



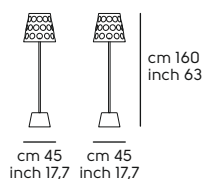

#### Bolle F



# Charlotte design Tomas Dalla Torre

## Lamp Charlotte

Frame in: metal

| Model   | Code    | Type | -- | Frame   | Optional | G.ty | boxes | Kg  | M <sup>3</sup> |
|---|---------|------|----|---------|----------|------|-------|-----|----------------|
|   |         |      |    |         | M1       |      |       |     |                |
| <b>Table lamp CHARLOTTE</b><br>   | A3030A1 | T    |    | 331 €   |          | 1    | 1     | 2   | 0.02           |
| <b>Floor lamp CHARLOTTE</b><br>   | A3030T1 | F    |    | 626 €   |          | 1    | 1     | 9   | 0.215          |
| <b>Suspension CHARLOTTE</b><br>  | A3030L1 | S    |    | 370 €   |          | 1    | 1     | 1.5 | 0.01           |
| <b>Chandelier CHARLOTTE</b><br> | A3030L6 | C    |    | 1.122 € |          | 1    | 1     | 8   | 0.32           |

**Note:**

Bulb not included - E27 socket





**Frame finishes**

**Metal**

**MI** BLACK EN

# Lamp Charlotte Color

Frame in: metal

| Model   | Code    | Type | -- | Frame   |         | Optional | Q.ty | boxes | Kg  | M³    |
|---|---------|------|----|---------|---------|----------|------|-------|-----|-------|
|   |         |      |    | M1      | M2      |          |      |       |     |       |
| <b>Table lamp CHARLOTTE COLOR</b><br>  | A3032A1 | T    |    | 397 €   | 397 €   |          | 1    | 1     | 2   | 0.02  |
| <b>Floor lamp CHARLOTTE COLOR</b><br>  | A3032T1 | F    |    | 751 €   | 751 €   |          | 1    | 1     | 9   | 0.215 |
| <b>Suspension CHARLOTTE COLOR</b><br>  | A3032L1 | S    |    | 444 €   | 444 €   |          | 1    | 1     | 1.5 | 0.01  |
| <b>Chandelier CHARLOTTE COLOR</b><br> | A3032L6 | C    |    | 1.347 € | 1.347 € |          | 1    | 1     | 8   | 0.32  |

**Note:**  
Bulb not included - E27 socket

## Frame finishes

### Metal

**M1** WHITE **BB**, BROWN **E6**, SAND **EC**, WHITE PEARL **EF**, GRAPHITE **EG**

**M2** LIGHT BLUE **E0**, OCEAN BLUE **E1**, BRONZE **E2**, FANGO **E3**, PASTEL YELLOW **E4**, OCHER YELLOW **E7**, FACEPOWDER PINK **E8**, SAGE GREEN **E9**, PAPAYA ORANGE **EA**, BLUE SAPPHIRE **EE**, BLUE TURQUOISE **EH**, PINE GREEN **EJ**, DARK GREEN **EL**, GOLDEN YELLOW **EO**, CHERRY RED **EQ**, RED **ER**, ASH GREY **ES**, LIGHT GREY **ET**, BULGARRO RED **FP**

### Charlotte T

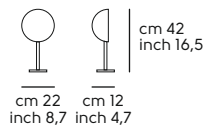

### Charlotte F

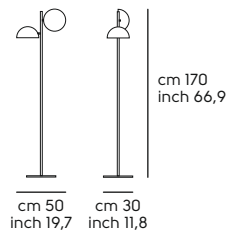

### Charlotte S

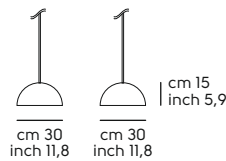

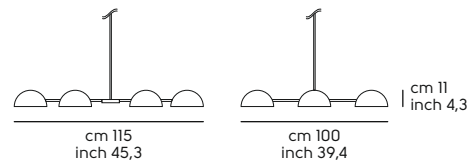

### Charlotte C



# Ghost design Studio F+B

## Lamp Ghost

Frame in: metal

| Model   | Code    | Type | -- | Frame | Optional | G.ty | boxes | Kg  | M <sup>3</sup> |
|---|---------|------|----|-------|----------|------|-------|-----|----------------|
|   |         |      |    | M1    |          |      |       |     |                |
| <b>Table lamp GHOST</b>   |         |      |    |       |          |      |       |     |                |
|   | A3020A1 | T    |    | 370 € |          | 1    | 1     | 2   | 0.03           |
| <b>Floor lamp GHOST</b>   |         |      |    |       |          |      |       |     |                |
|   | A3020T1 | F    |    | 690 € |          | 1    | 1     | 5.8 | 0.25           |
| <b>Suspension GHOST</b>   |         |      |    |       |          |      |       |     |                |
|  | A3020L1 | S    |    | 459 € |          | 1    | 1     | 2   | 0.03           |

**Note:**

Bulb not included - PTL GU 10 socket

**Frame finishes**

**Metal**

**MI** BLACK EN

**Ghost T**

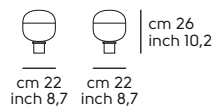

**Ghost F**

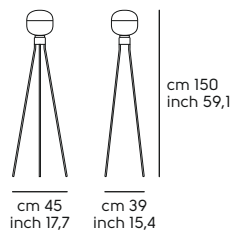



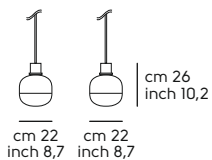



**Ghost S**



# Japan design Opaca Lab+Tosca Design

## Lamp Japan

Frame in: metal

| Model  | Code    | Type | -- | Frame | Optional | G.ty | boxes | Kg   | M <sup>3</sup> |
|--|---------|------|----|-------|----------|------|-------|------|----------------|
|  |         |      |    | M1    |          |      |       |      |                |
| <b>Floor lamp JAPAN</b><br>                     | A3000T1 | F    |    | 754 € |          | 1    | 1     | 18   | 0.26           |
| <b>Suspension JAPAN S</b><br>                   | A3000L1 | S    |    | 378 € |          | 1    | 1     | 1.5  | 0.023          |
| <b>Suspension JAPAN M</b><br>                  | A3000L2 | M    |    | 402 € |          | 1    | 1     | 1.6  | 0.033          |
| <b>Suspension JAPAN L</b><br>                 | A3000L3 | L    |    | 435 € |          | 1    | 1     | 2.5  | 0.060          |
| <b>Suspension rose JAPAN</b><br>              | A3000R0 | R    |    | 45 €  |          | 1    | 1     | 0.30 | 0.002          |
| <b>Suspension multiple rose JAPAN (6)</b><br> | A3000R0 | RM   |    | 45 €  | RS-M2    | 1    | 1     | 0.80 | 0.005          |

### Note:

Bulb not included - PTL GU 10 socket

### Frame finishes

#### Metal











**MI** WHITE BB, BLACK EN

### Optionals:

|                                   | Value | Options/notes |
|-----------------------------------|-------|---------------|
| <b>RS-M2</b>   Multiple lamp rose | + 5 € | RS-M2         |

## Lamp Japan Color

Frame in: metal

| Model   | Code    | Type | -- | Frame |       | Optional | Q.ty<br> | boxes<br> | Kg<br> | M³<br> |
|---|---------|------|----|-------|-------|----------|---|--|---|---|
|   |         |      |    | M1    | M2    |          |   |  |   |   |
| <br><b>Floor lamp JAPAN COLOR</b>                     | A3002T1 | F    |    | 905 € | 905 € |          | 1   | 1  | 18  | 0.26  |
| <br><b>Suspension JAPAN COLOR S</b>                   | A3002L1 | S    |    | 453 € | 453 € |          | 1   | 1  | 1.5   | 0.023   |
| <br><b>Suspension JAPAN COLOR M</b>                   | A3002L2 | M    |    | 483 € | 483 € |          | 1   | 1  | 1.6   | 0.033   |
| <br><b>Suspension JAPAN COLOR L</b>                  | A3002L3 | L    |    | 522 € | 522 € |          | 1   | 1  | 2.5   | 0.060   |
| <br><b>Suspension rose JAPAN COLOR</b>              | A3002R0 | R    |    | 62 €  | 62 €  |          | 1   | 1  | 0.30  | 0.002   |
| <br><b>Suspension multiple rose JAPAN COLOR (6)</b> | A3002R0 | RM   |    | 62 €  | 62 €  | RS-M2    | 1   | 1  | 0.80  | 0.005   |

**Note:**

Bulb not included - PTL GU 10 socket

**Frame finishes**

**Metal**

**M1** BROWN **E6**, SAND **EC**, WHITE PEARL **EF**, GRAPHITE **EG**

**M2** LIGHT BLUE **E0**, OCEAN BLUE **E1**, BRONZE **E2**, FANGO **E3**, PASTEL YELLOW **E4**, OCHER YELLOW **E7**, FACEPOWDER PINK **E8**, SAGE GREEN **E9**, PAPAYA ORANGE **EA**, BLUE SAPPHIRE **EE**, BLUE TURQUOISE **EH**, PINE GREEN **EJ**, DARK GREEN **EL**, GOLDEN YELLOW **EO**, CHERRY RED **EQ**, RED **ER**, ASH GREY **ES**, LIGHT GREY **ET**, BULGARO RED **FP**

**Optionals:**

|                                 | Value  | Options/notes |
|---------------------------------|--------|---------------|
| <b>RS-M2</b> Multiple lamp rose | + 10 € | RS-M2         |

**Japan F**

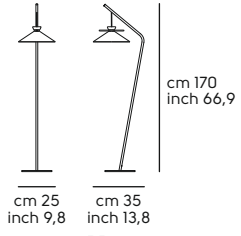

**Japan S**

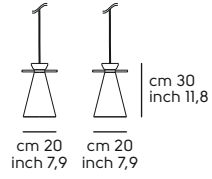

**Japan M**

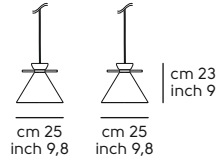

**Japan L**

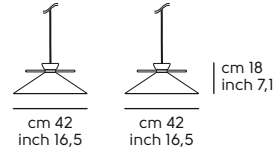

**Japan R**

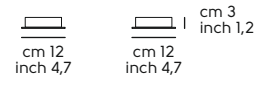



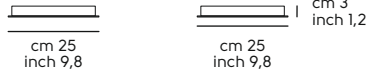

**Japan RM**



# Mug design Gabriele Panciera

## Lamp Mug

Frame in: metal and hide

| Model  | Code    | Type | Frame | Upholstery |         | Optional | G.ty | boxes | Kg | M³   |
|--|---------|------|-------|------------|---------|----------|------|-------|----|------|
|  |         |      |       | CK         | CT      |          |      |       |    |      |
| <b>Table lamp MUG</b><br>  | A3040A1 | T    | MI    | 568 €      | 589 €   |          | 1    | 2     | 3  | 0.06 |
| <b>Floor lamp MUG</b><br>  | A3040T1 | F    | MI    | 863 €      | 884 €   |          | 1    | 2     | 11 | 0.27 |
| <b>Suspension MUG</b><br> | A3040L1 | S    | MI    | 517 €      | 538 €   |          | 1    | 3     | 4  | 0.07 |
| <b>MUG XL Bronze</b><br> | A3040T3 | XL   | MI    | 2.142 €    | 2.330 € |          | 1    | 2     | 21 | 0.12 |

### Note:

Bulb INCLUDED - MUG T and MUG F Cable in Black Fabric 2 mt. - MUG S Cable in Black Fabric 3 mt.

### Frame finishes

#### Metal



**MI** BLACK EN

### Upholstery finishes

#### Hide

**CK** HIDE\_TK

**CT** TUSCAN HIDE

| Model   | Code    | Type | -- | Frame | Optional | G.ty | boxes | Kg  | M³   |
|---|---------|------|----|-------|----------|------|-------|-----|------|
|   |         |      |    |       |          |      |       |     |      |
| <b>Suspension rose MUG</b><br>              | A3040R0 | R    |    | 86 €  |          | 1    | 1     | 1.5 | 0.01 |
| <b>Suspension multiple rose MUG (6)</b><br> | A3040R0 | RM   |    | 86 €  | RS-M2    | 1    | 1     | 1.5 | 0.01 |

**Frame finishes**

**Metal**

|           |          |
|-----------|----------|
| <b>MI</b> | BLACK EN |
|-----------|----------|

**Optionals:**

|              |                    | Value   | Options/notes |
|--------------|--------------------|---------|---------------|
| <b>RS-M2</b> | Multiple lamp rose | + 120 € | RS-M2         |

**Mug T**

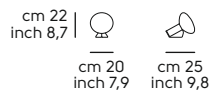

**Mug F**

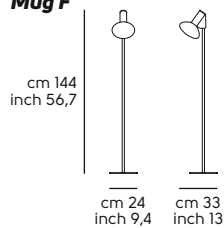

**Mug S**

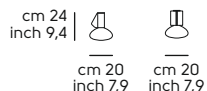

**Mug XL**

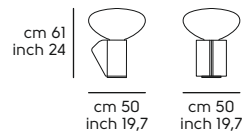

**Mug R**

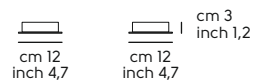

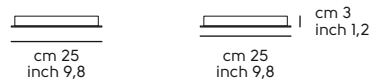

**Mug RM**



# Suspense design Studio F+B

## Lamp Suspense

Frame in: metal

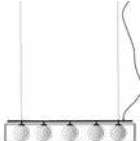
| Model   | Code    | Type | -- | Frame   | Optional | G.ty | boxes | Kg    | M <sup>3</sup> |
|---|---------|------|----|---------|----------|------|-------|-------|----------------|
|   |         |      |    |         | M1       |      |       |       |                |
| <b>Table lamp SUSPENSE</b><br>  | A3010A1 | T    |    | 339 €   |          | 1    | 1     | 2.9   | 0.024          |
| <b>Floor lamp SUSPENSE</b><br>  | A3010T1 | F    |    | 882 €   |          | 1    | 1     | 16.5  | 0.215          |
| <b>Chandelier SUSPENSE</b><br> | A3010L5 | C    |    | 1.184 € |          | 1    | 1     | 11.25 | 0.114          |

**Note:**

Bulb not included - Type G9 Led socket

**Frame finishes**

**Metal**

**MI** BLACK EN

**Suspense T**

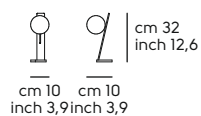

**Suspense F**

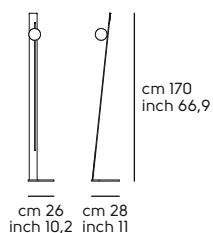

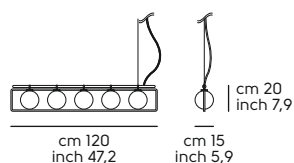

**Suspense C**



# Sunrise design Franco Poli

## Separè Sunrise

Frame in: metal

| Model   | Code      | -- | Frame | Mesh  |       | Optional       | G.ty | boxes | Kg   | M <sup>2</sup> |
|---|-----------|----|-------|-------|-------|----------------|------|-------|------|----------------|
|   |           |    |       | CK    | CT    |                |      |       |      |                |
| <b>Separè SUNRISE H.190</b><br>  | A2100SP01 |    | M1    | 690 € | 843 € | FM-M2<br>FM-M4 | 1    | 1     | 14   | 0.65           |
| <b>Separè SUNRISE H.170</b><br>  | A2100SP02 |    | M1    | 721 € | 888 € | FM-M2<br>FM-M4 | 1    | 1     | 14.5 | 0.68           |
| <b>Separè SUNRISE H.128</b><br> | A2100SP03 |    | M1    | 750 € | 919 € | FM-M2<br>FM-M4 | 1    | 1     | 15   | 0.82           |

### Frame finishes

#### Metal

**M1** WHITE **BB**, BROWN **E6**, SAND **EC**, WHITE PEARL **EF**, GRAPHITE **EG**, BLACK **EN**

### Mesh finishes

#### Hide

**CK** HIDE\_TK

**CT** TUSCAN HIDE

### Optionals:

|              |                        | Value   | Options/notes  |
|--------------|------------------------|---------|--|
| <b>FM-M2</b> | Indoor matt metal M2   | + 102 € | ASH GREY <b>ES</b> , BLUE SAPPHIRE <b>EE</b> , BLUE TURQUOISE <b>EH</b> , BRONZE <b>E2</b> , BULGARO RED <b>FP</b> , CHERRY RED <b>EQ</b> , DARK GREEN <b>EL</b> , FACEPOWDER PINK <b>E8</b> , FANGO <b>E3</b> , GOLDEN YELLOW <b>EO</b> , LIGHT BLUE <b>EO</b> , LIGHT GREY <b>ET</b> , OCEAN BLUE <b>E1</b> , OCHER YELLOW <b>E7</b> , PAPAYA ORANGE <b>EA</b> , PASTEL YELLOW <b>E4</b> , PINE GREEN <b>EJ</b> , RED <b>ER</b> , SAGE GREEN <b>E9</b> |
| <b>FM-M4</b> | Indoor glossy Metal M4 | + 153 € | BLACK NICKEL <b>DZ</b> , CHAMPAGNE GOLD <b>DG</b> , GOLDEN BRONZE <b>DB</b> , MATT BLACK NICKEL <b>DY</b> , MATT GOLDEN BRONZE <b>DC</b> , PINK GOLD <b>DR</b>   |

### Sunrise H.190

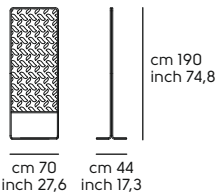

### Sunrise H.170

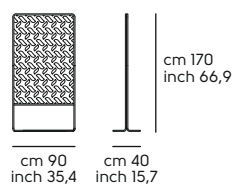

### Sunrise H.128

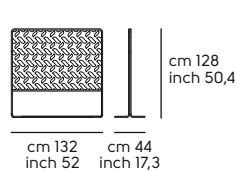



# Bases

# Break design Officina delle Idee

## Frame Break

Frame in: metal Top NOT included

| Version   | Code     | H     | -- | Frame       | Optional    | G.ty        | boxes       | Kg | M <sup>3</sup> |     |      |
|---|----------|-------|----|-------------|-------------|-------------|-------------|----|----------------|-----|------|
| <b>Break H. 73</b>  |          |       |    |             |             |             |             |    |                |     |      |
| <b>BREAK /3 H 73</b><br>Top Max Ø 70<br>         | T1040BT3 | H. 73 |    | M1<br>125 € | M2<br>203 € | O1<br>162 € | O2<br>236 € |    |                |     |      |
|   |          |       |    |             |             |             |             | 1  | 2              | 6   | 0.20 |
| <b>BREAK /4 H 73</b><br>Top Max 70x70 - Ø 80<br> | T1040BT4 | H. 73 |    | M1<br>135 € | M2<br>213 € | O1<br>174 € | O2<br>248 € |    |                |     |      |
|   |          |       |    |             |             |             |             | 1  | 2              | 6.5 | 0.20 |

### Frame finishes

#### Metal

|           |  |
|-----------|--|
| <b>M1</b> | WHITE <b>BB</b> , BROWN <b>E6</b> , SAND <b>EC</b> , WHITE PEARL <b>EF</b> , GRAPHITE <b>EG</b> , BLACK <b>EN</b>  |
| <b>M2</b> | LIGHT BLUE <b>E0</b> , OCEAN BLUE <b>E1</b> , BRONZE <b>E2</b> , FANGO <b>E3</b> , PASTEL YELLOW <b>E4</b> , OCHER YELLOW <b>E7</b> , FACEPOWDER PINK <b>E8</b> , SAGE GREEN <b>E9</b> , PAPAYA ORANGE <b>EA</b> , BLUE SAPPHIRE <b>EE</b> , BLUE TURQUOISE <b>EH</b> , PINE GREEN <b>EJ</b> , DARK GREEN <b>EL</b> , GOLDEN YELLOW <b>EO</b> , CHERRY RED <b>EQ</b> , RED <b>ER</b> , ASH GREY <b>ES</b> , LIGHT GREY <b>ET</b> , BULGARO RED <b>FP</b> |

#### Metal Outdoor

|           |  |
|-----------|--|
| <b>O1</b> | Outdoor BROWN <b>E6</b> , Outdoor WHITE <b>BB</b> , Outdoor SAND <b>EC</b> , Outdoor WHITE PEARL <b>EF</b> , Outdoor GRAFITE <b>EG</b> , Outdoor BLACK <b>EN</b>   |
| <b>O2</b> | Outdoor LIGHT BLUE <b>E0</b> , Outdoor OCEAN BLUE <b>E1</b> , Outdoor BRONZE <b>E2</b> , Outdoor FANGO <b>E3</b> , Outdoor PASTEL YELLOW <b>E4</b> , Outdoor OCHER YELLOW <b>E7</b> , Outdoor FACEPOWDER PINK <b>E8</b> , Outdoor SAGE GREEN <b>E9</b> , Outdoor BLUE SAPPHIRE <b>EE</b> , Outdoor BLUE TURQUOISE <b>EH</b> , Outdoor PINE GREEN <b>EJ</b> , Outdoor DARK GREEN <b>EL</b> , Outdoor GOLD YELLOW <b>EO</b> , Outdoor RED BULGARO <b>FP</b> , Outdoor CHERRY RED <b>EQ</b> , Outdoor RED <b>ER</b> , Outdoor ASH GREY <b>ES</b> , Outdoor LIGHT GREY <b>ET</b> , Outdoor PAPAYA ORANGE <b>EA</b> |

#### Break /3 H 73

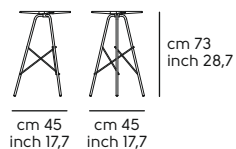



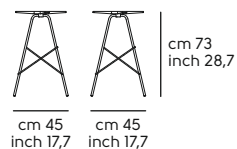

#### Break /4 H 73



# Clessidra design Paolo Vernier

## Frame Clessidra

Frame in: metal Top NOT included

| Version  | Code      | H     | -- | Frame   |         | Optional | G.ty | boxes | Kg   | M <sup>2</sup> |
|--|-----------|-------|----|---------|---------|----------|------|-------|------|----------------|
|  |           |       |    | M1      | M2      |          |      |       |      |                |
| <b>CLESSIDRA M42 H73</b><br>Top Ø70-Ø80-Ø90<br>  | TI960M420 | H. 73 |    | 552 €   | 638 €   |          | 1    | 1     | 23.5 | 0.08           |
| <b>CLESSIDRA M Ø100-120</b><br>Top Ø100-Ø120<br> | TI960B120 | H. 73 |    | 1.061 € | 1.146 € |          | 1    | 1     | 46   | 0.30           |
| <b>CLESSIDRA M Ø150</b><br>Top Ø150-Ø180<br>    | TI960B150 | H. 73 |    | 2.250 € | 2.378 € |          | 1    | 1     | 125  | 0.73           |
| <b>CLESSIDRA M Elliptical 220</b><br>          | TI960B220 | H. 73 |    | 2.990 € | 3.180 € |          | 1    | 1     | 136  | 0.82           |
| <b>CLESSIDRA M Elliptical 250</b><br>          | TI960B250 | H. 73 |    | 2.990 € | 3.180 € |          | 1    | 1     | 144  | 0.82           |

Note:

--

### Frame finishes

#### Metal

|           |   |
|-----------|---|
| <b>M1</b> | WHITE <b>BB</b> , BROWN <b>E6</b> , SAND <b>EC</b> , WHITE PEARL <b>EF</b> , GRAPHITE <b>EG</b> , BLACK <b>EN</b>   |
| <b>M2</b> | LIGHT BLUE <b>E0</b> , OCEAN BLUE <b>E1</b> , FANGO <b>E3</b> , PASTEL YELLOW <b>E4</b> , OCHER YELLOW <b>E7</b> , FACEPOWDER PINK <b>E8</b> , SAGE GREEN <b>E9</b> , PAPAYA ORANGE <b>EA</b> , BLUE SAPPHIRE <b>EE</b> , BLUE TURQUOISE <b>EH</b> , PINE GREEN <b>EJ</b> , DARK GREEN <b>EL</b> , GOLDEN YELLOW <b>EO</b> , CHERRY RED <b>EQ</b> , RED <b>ER</b> , ASH GREY <b>ES</b> , LIGHT GREY <b>ET</b> , BRONZE <b>EZ</b> + TRANSP., BULGARO RED <b>FP</b> |

**Metal**

|           |   |
|-----------|---|
| <b>M1</b> | WHITE <b>BB</b> , BROWN <b>E6</b> , SAND <b>EC</b> , WHITE PEARL <b>EF</b> , GRAPHITE <b>EG</b> , BLACK <b>EN</b>   |
| <b>M2</b> | LIGHT BLUE <b>E0</b> , OCEAN BLUE <b>E1</b> , FANGO <b>E3</b> , PASTEL YELLOW <b>E4</b> , OCHER YELLOW <b>E7</b> , FACEPOWDER PINK <b>E8</b> , SAGE GREEN <b>E9</b> , PAPAYA ORANGE <b>EA</b> , BLUE SAPPHIRE <b>EE</b> , BLUE TURQUOISE <b>EH</b> , PINE GREEN <b>EJ</b> , DARK GREEN <b>EL</b> , GOLDEN YELLOW <b>EO</b> , CHERRY RED <b>EQ</b> , RED <b>ER</b> , ASH GREY <b>ES</b> , LIGHT GREY <b>ET</b> , BRONZE <b>EZ</b> + TRANSP., BULGARO RED <b>FP</b> |
| <b>M4</b> | GOLDEN BRONZE <b>DB</b> , MATT GOLDEN BRONZE <b>DC</b> , CHAMPAGNE GOLD <b>DG</b> , PINK GOLD <b>DR</b> , MATT BLACK NICKEL <b>DY</b> , BLACK NICKEL <b>DZ</b>  |

**Clessidra M42 H73**

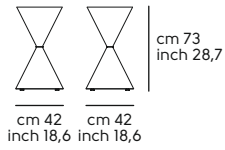

**Clessidra D.100-120**

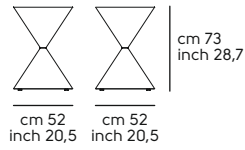

**Clessidra D.150**

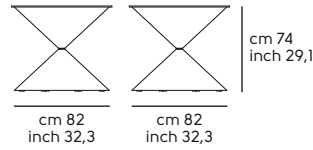

**Clessidra Elliptical 220**

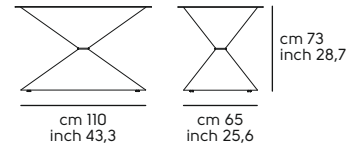

**Clessidra Elliptical 250**

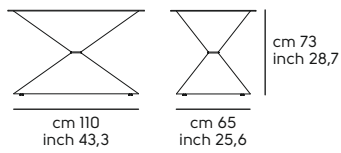

# Composit design *Officina delle Idee*

## Frame Composit 1 / 2 / 3

Frame in: metal Top NOT included

| Version | Code | H | Base | Column | Optional | G.ty | boxes | Kg | M <sup>2</sup> |
|---------|------|---|------|--------|----------|------|-------|----|----------------|
|---------|------|---|------|--------|----------|------|-------|----|----------------|

### Composit H. 73

Version for Wood and HPL Top

|  |          |       |    | M1    | M3    |       |   |   |      |
|--|----------|-------|----|-------|-------|-------|---|---|------|
|  <p><b>COMPOSIT/1 Base 45x45 - Col. 8x8</b><br/>Top Max 80x80 - Ø 90</p> |          |       |    |       |       |       |   |   |      |
|  | T1061Q45 | H. 73 | MI | 264 € | 287 € | FM-M5 | 1 | 3 | 24.5 |

#### Optionals:

|              |                    | Value  | Options/notes               |
|--------------|--------------------|--------|-----------------------------|
| <b>FM-M5</b> | Stainless steel M5 | + 21 € | POLISHED STAINLESS STEEL HL |

|  <p><b>COMPOSIT/1 Base 55x55 - Col. 8x8</b><br/>Top Max 90x90 - Ø 100</p> |          |       |    |       |       |       |   |   |    |
|---|----------|-------|----|-------|-------|-------|---|---|----|
|   | T1061Q55 | H. 73 | MI | 320 € | 342 € | FM-M5 | 1 | 3 | 30 |

#### Optionals:

|              |                    | Value  | Options/notes               |
|--------------|--------------------|--------|-----------------------------|
| <b>FM-M5</b> | Stainless steel M5 | + 21 € | POLISHED STAINLESS STEEL HL |

|  <p><b>COMPOSIT/2 Base 45x45 - Col. Ø 8</b><br/>Top Max 80x80 - Ø 90</p> |          |       |    |       |       |       |   |   |      |
|--|----------|-------|----|-------|-------|-------|---|---|------|
|  | T1062Q45 | H. 73 | MI | 257 € | 275 € | FM-M5 | 1 | 3 | 24.5 |

#### Optionals:

|              |                    | Value  | Options/notes               |
|--------------|--------------------|--------|-----------------------------|
| <b>FM-M5</b> | Stainless steel M5 | + 21 € | POLISHED STAINLESS STEEL HL |

|  <p><b>COMPOSIT/2 Base 55x55 - Col. Ø 8</b><br/>Top Max 90x90 - Ø 100</p> |          |       |    |       |       |       |   |   |    |
|---|----------|-------|----|-------|-------|-------|---|---|----|
|   | T1062Q55 | H. 73 | MI | 287 € | 315 € | FM-M5 | 1 | 3 | 30 |

#### Optionals:

|              |                    | Value  | Options/notes               |
|--------------|--------------------|--------|-----------------------------|
| <b>FM-M5</b> | Stainless steel M5 | + 21 € | POLISHED STAINLESS STEEL HL |

**COMPOSIT/3 Base Ø 45 - Col. Ø 8**

Top Max 70x70 - Ø 80



TI063D45

H. 73

M1

245 €

264 €

FM-M5

1

3

24.5

0.05

**Optionals:**

|              |                    | Value  | Options/notes               |
|--------------|--------------------|--------|-----------------------------|
| <b>FM-M5</b> | Stainless steel M5 | + 21 € | POLISHED STAINLESS STEEL HL |

**COMPOSIT/3 Base Ø 55 - Col. Ø 8**

Top Max 70x70 - Ø 90



TI063D55

H. 73

M1

285 €

306 €

FM-M5

1

3

30

0.06

**Optionals:**

|              |                    | Value  | Options/notes               |
|--------------|--------------------|--------|-----------------------------|
| <b>FM-M5</b> | Stainless steel M5 | + 21 € | POLISHED STAINLESS STEEL HL |

| Version | Code | Base | Column | Optional | Q.ty | boxes | Kg | M <sup>2</sup> |
|---------|------|------|--------|----------|------|-------|----|----------------|
|---------|------|------|--------|----------|------|-------|----|----------------|

**Composit H. 73**

Version for Glass top

|   |          |       | M1 | M3    |       |       |   |   |      |      |
|---|----------|-------|----|-------|-------|-------|---|---|------|------|
| <b>COMPOSIT/1 Base 45x45 - Col. 8x8 *Vtr</b>  |          |       |    |       |       |       |   |   |      |      |
| Top Max 80x80 - Ø 90  |          |       |    |       |       |       |   |   |      |      |
|  | TI066Q45 | H. 73 | M1 | 258 € | 280 € | FM-M5 | 1 | 2 | 23.5 | 0.05 |

**Optionals:**

|              |                    | Value  | Options/notes               |
|--------------|--------------------|--------|-----------------------------|
| <b>FM-M5</b> | Stainless steel M5 | + 21 € | POLISHED STAINLESS STEEL HL |

**COMPOSIT/1 Base 55x55 - Col. 8x8 \*Vtr**

Top Max 90x90 - Ø 100



TI066Q55

H. 73

M1

312 €

336 €

FM-M5

1

2

29

0.06

**Optionals:**

|              |                    | Value  | Options/notes               |
|--------------|--------------------|--------|-----------------------------|
| <b>FM-M5</b> | Stainless steel M5 | + 21 € | POLISHED STAINLESS STEEL HL |

**COMPOSIT/2 Base 45x45 - Col. Ø 8 \*Vtr**

Top Max 80x80 - Ø 90



TI067Q45

H. 73

M1

249 €

265 €

FM-M5

1

2

23.5

0.05

| Optionals:   |                    | Value  | Options/notes               |
|--------------|--------------------|--------|-----------------------------|
| <b>FM-M5</b> | Stainless steel M5 | + 21 € | POLISHED STAINLESS STEEL HL |

| Optionals:   |                    | Value  | Options/notes               |
|--------------|--------------------|--------|-----------------------------|
| <b>FM-M5</b> | Stainless steel M5 | + 21 € | POLISHED STAINLESS STEEL HL |

| COMPOSIT/2 Base 55x55 - Col. Ø 8 *Vtr<br>Top Max 90x90 - Ø 100                   |          |       |    |       |       |       |   |   |    |      |  |  |
|--|----------|-------|----|-------|-------|-------|---|---|----|------|--|--|
|  | T1067Q55 | H. 73 | MI | 266 € | 308 € | FM-M5 | 1 | 2 | 29 | 0.06 |  |  |

| Optionals:   |                    | Value  | Options/notes               |
|--------------|--------------------|--------|-----------------------------|
| <b>FM-M5</b> | Stainless steel M5 | + 21 € | POLISHED STAINLESS STEEL HL |

| Optionals:   |                    | Value  | Options/notes               |
|--------------|--------------------|--------|-----------------------------|
| <b>FM-M5</b> | Stainless steel M5 | + 21 € | POLISHED STAINLESS STEEL HL |

| COMPOSIT/3 Base Ø 45 - Col. Ø 8 *Vtr<br>Top Max 70x70 - Ø 80                     |          |       |    |       |       |       |   |   |      |      |  |  |
|--|----------|-------|----|-------|-------|-------|---|---|------|------|--|--|
|  | T1068D45 | H. 73 | MI | 237 € | 258 € | FM-M5 | 1 | 2 | 23.5 | 0.05 |  |  |

| Optionals:   |                    | Value  | Options/notes               |
|--------------|--------------------|--------|-----------------------------|
| <b>FM-M5</b> | Stainless steel M5 | + 21 € | POLISHED STAINLESS STEEL HL |

| Optionals:   |                    | Value  | Options/notes               |
|--------------|--------------------|--------|-----------------------------|
| <b>FM-M5</b> | Stainless steel M5 | + 21 € | POLISHED STAINLESS STEEL HL |

| COMPOSIT/3 Base Ø 55 - Col. Ø 8 *Vtr<br>Top Max 70x70 - Ø 90                       |          |       |    |       |       |       |   |   |    |      |  |  |
|--|----------|-------|----|-------|-------|-------|---|---|----|------|--|--|
|  | T1068D55 | H. 73 | MI | 265 € | 301 € | FM-M5 | 1 | 2 | 29 | 0.06 |  |  |

| Optionals:   |                    | Value  | Options/notes               |
|--------------|--------------------|--------|-----------------------------|
| <b>FM-M5</b> | Stainless steel M5 | + 21 € | POLISHED STAINLESS STEEL HL |

| Frame finishes |                    |
|----------------|--------------------|
| <b>Metal</b>   |                    |
| <b>M1</b>      | WHITE BB, BLACK EN |

| Frame finishes |                    |
|----------------|--------------------|
| <b>Metal</b>   |                    |
| <b>M1</b>      | WHITE BB, BLACK EN |
| <b>M3</b>      | CHROME CC          |

**Composit/1 H. 73 Base  
45x45 - Col. 8x8**

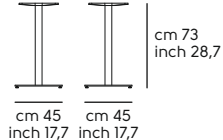

**Composit/1 H. 73 Base  
55x55 - Col. 8x8**

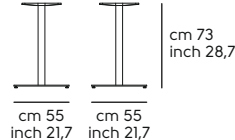

**Composit/2 H. 73 Base  
45x45 - Col. Ø 8**

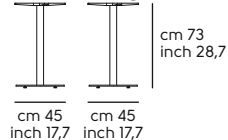

**Composit/2 H. 73 Base  
55x55 - Col. Ø 8**

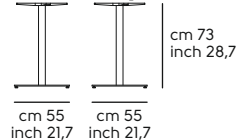

**Composit/3 H. 73 Base  
Ø 45 - Col. Ø 8**

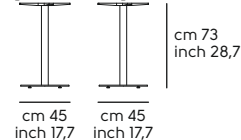

**Composit/3 H. 73 Base  
Ø 55 - Col. Ø 8**

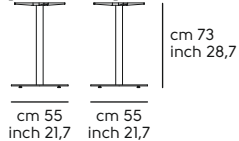

| Version | Code | H | Base | Column | Optional | Q.ty | boxes | Kg | M <sup>3</sup> |
|---------|------|---|------|--------|----------|------|-------|----|----------------|
|---------|------|---|------|--------|----------|------|-------|----|----------------|

**Composit H.107**

Version for Wood and HPL Top

|   |          |       |    | M1    | M3    |       |   |   |      |
|---|----------|-------|----|-------|-------|-------|---|---|------|
|  <p><b>COMPOSIT/1 Base 45x45 - Col. 8x8</b><br/>Top Max 70x70 - Ø 80</p> |          |       |    |       |       |       |   |   |      |
|   | T1061Q45 | H.107 | M1 | 289 € | 312 € | FM-M5 | 1 | 3 | 28.5 |

**Optionals:**

|                                   | Value  | Options/notes               |
|-----------------------------------|--------|-----------------------------|
| <b>FM-M5</b>   Stainless steel M5 | + 21 € | POLISHED STAINLESS STEEL HL |

|   |          |       |    |       |       |       |   |   |    |
|---|----------|-------|----|-------|-------|-------|---|---|----|
|  <p><b>COMPOSIT/1 Base 55x55 - Col. 8x8</b><br/>Top Max 80x80 - Ø 90</p> |          |       |    |       |       |       |   |   |    |
|   | T1061Q55 | H.107 | M1 | 345 € | 367 € | FM-M5 | 1 | 3 | 34 |

**Optionals:**

|                                   | Value  | Options/notes               |
|-----------------------------------|--------|-----------------------------|
| <b>FM-M5</b>   Stainless steel M5 | + 21 € | POLISHED STAINLESS STEEL HL |

|   |          |       |    |       |       |       |   |   |      |
|---|----------|-------|----|-------|-------|-------|---|---|------|
|  <p><b>COMPOSIT/2 Base 45x45 - Col. Ø 8</b><br/>Top Max 70x70 - Ø 80</p> |          |       |    |       |       |       |   |   |      |
|   | T1062Q45 | H.107 | M1 | 282 € | 300 € | FM-M5 | 1 | 3 | 28.5 |

**Optionals:**

|                                   | Value  | Options/notes               |
|-----------------------------------|--------|-----------------------------|
| <b>FM-M5</b>   Stainless steel M5 | + 21 € | POLISHED STAINLESS STEEL HL |

|   |          |       |    |       |       |       |   |   |    |
|---|----------|-------|----|-------|-------|-------|---|---|----|
|  <p><b>COMPOSIT/2 Base 55x55 - Col. Ø 8</b><br/>Top Max 80x80 - Ø 90</p> |          |       |    |       |       |       |   |   |    |
|   | T1062Q55 | H.107 | M1 | 312 € | 340 € | FM-M5 | 1 | 3 | 34 |

**Optionals:**

|                                   | Value  | Options/notes               |
|-----------------------------------|--------|-----------------------------|
| <b>FM-M5</b>   Stainless steel M5 | + 21 € | POLISHED STAINLESS STEEL HL |

|  |          |       |    |       |       |       |   |   |      |
|--|----------|-------|----|-------|-------|-------|---|---|------|
|  <p><b>COMPOSIT/3 Base Ø 45 - Col. Ø 8</b><br/>Top Max 70x70 - Ø 80</p> |          |       |    |       |       |       |   |   |      |
|  | T1063D45 | H.107 | M1 | 270 € | 289 € | FM-M5 | 1 | 3 | 28.5 |

**Optionals:**

|                                   | Value  | Options/notes               |
|-----------------------------------|--------|-----------------------------|
| <b>FM-M5</b>   Stainless steel M5 | + 21 € | POLISHED STAINLESS STEEL HL |

COMPOSIT/3 Base Ø 55 - Col. Ø 8  
Top Max 70x70 - Ø 80



|          |       |    |       |       |       |   |   |    |      |
|----------|-------|----|-------|-------|-------|---|---|----|------|
| T1063D55 | H.107 | M1 | 310 € | 331 € | FM-M5 | 1 | 3 | 34 | 0.06 |
|----------|-------|----|-------|-------|-------|---|---|----|------|

**Optionals:**

|              |                    | Value  | Options/notes               |
|--------------|--------------------|--------|-----------------------------|
| <b>FM-M5</b> | Stainless steel M5 | + 21 € | POLISHED STAINLESS STEEL HL |

| Version | Code | Base | Column | Optional | Q.ty | boxes | Kg | M³ |
|---------|------|------|--------|----------|------|-------|----|----|
|---------|------|------|--------|----------|------|-------|----|----|

**Composit H.107**  
Version for Glass top

|   |          |       | M1 | M3    |       |       |   |   |      |      |
|---|----------|-------|----|-------|-------|-------|---|---|------|------|
| COMPOSIT/1 Base 45x45 - Col. Øx8 *Vtr<br>Top Max 70x70 - Ø 80 | T1066Q45 | H.107 | M1 | 283 € | 305 € | FM-M5 | 1 | 2 | 27.5 | 0.05 |

**Optionals:**

|              |                    | Value  | Options/notes               |
|--------------|--------------------|--------|-----------------------------|
| <b>FM-M5</b> | Stainless steel M5 | + 21 € | POLISHED STAINLESS STEEL HL |

COMPOSIT/1 Base 55x55 - Col. Øx8 \*Vtr  
Top Max 80x80 - Ø 90



|          |       |    |       |       |       |   |   |    |      |
|----------|-------|----|-------|-------|-------|---|---|----|------|
| T1066Q55 | H.107 | M1 | 337 € | 361 € | FM-M5 | 1 | 2 | 33 | 0.06 |
|----------|-------|----|-------|-------|-------|---|---|----|------|

**Optionals:**

|              |                    | Value  | Options/notes               |
|--------------|--------------------|--------|-----------------------------|
| <b>FM-M5</b> | Stainless steel M5 | + 21 € | POLISHED STAINLESS STEEL HL |

COMPOSIT/2 Base 45x45 - Col. Ø 8 \*Vtr  
Top Max 70x70 - Ø 80



|          |       |    |       |       |       |   |   |      |      |
|----------|-------|----|-------|-------|-------|---|---|------|------|
| T1067Q45 | H.107 | M1 | 274 € | 290 € | FM-M5 | 1 | 2 | 27.5 | 0.05 |
|----------|-------|----|-------|-------|-------|---|---|------|------|

**Optionals:**

|              |                    | Value  | Options/notes               |
|--------------|--------------------|--------|-----------------------------|
| <b>FM-M5</b> | Stainless steel M5 | + 21 € | POLISHED STAINLESS STEEL HL |

COMPOSIT/2 Base 55x55 - Col. Ø 8 \*Vtr  
Top Max 80x80 - Ø 90



|          |       |    |       |       |       |   |   |    |      |
|----------|-------|----|-------|-------|-------|---|---|----|------|
| T1067Q55 | H.107 | M1 | 291 € | 333 € | FM-M5 | 1 | 2 | 33 | 0.06 |
|----------|-------|----|-------|-------|-------|---|---|----|------|

**Optionals:**

|              |                    | Value  | Options/notes                      |
|--------------|--------------------|--------|------------------------------------|
| <b>FM-M5</b> | Stainless steel M5 | + 21 € | POLISHED STAINLESS STEEL <b>HL</b> |

**COMPOSIT/3 Base Ø 45 - Col. Ø 8 \*Vtr**  
Top Max 70x70 - Ø 80



|          |       |    |       |       |       |   |   |      |      |
|----------|-------|----|-------|-------|-------|---|---|------|------|
| T1068D45 | H.107 | M1 | 262 € | 283 € | FM-M5 | 1 | 2 | 28.5 | 0.05 |
|----------|-------|----|-------|-------|-------|---|---|------|------|

**Optionals:**

|              |                    | Value  | Options/notes                      |
|--------------|--------------------|--------|------------------------------------|
| <b>FM-M5</b> | Stainless steel M5 | + 21 € | POLISHED STAINLESS STEEL <b>HL</b> |

**COMPOSIT/3 Base Ø 55 - Col. Ø 8 \*Vtr**  
Top Max 70x70 - Ø 80



|          |       |    |       |       |       |   |   |    |      |
|----------|-------|----|-------|-------|-------|---|---|----|------|
| T1068D55 | H.107 | M1 | 290 € | 326 € | FM-M5 | 1 | 2 | 33 | 0.06 |
|----------|-------|----|-------|-------|-------|---|---|----|------|

**Optionals:**

|              |                    | Value  | Options/notes                      |
|--------------|--------------------|--------|------------------------------------|
| <b>FM-M5</b> | Stainless steel M5 | + 21 € | POLISHED STAINLESS STEEL <b>HL</b> |

**Frame finishes**

**Metal**

|           |                    |
|-----------|--------------------|
| <b>M1</b> | WHITE BB, BLACK EN |
|-----------|--------------------|

**Frame finishes**

**Metal**

|           |                    |
|-----------|--------------------|
| <b>M1</b> | WHITE BB, BLACK EN |
| <b>M3</b> | CHROME CC          |

**Composit/1 H.107 Base 45x45 - Col. 8x8**

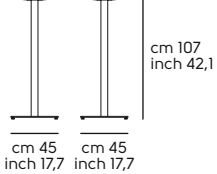

**Composit/1 H.107 Base 55x55 - Col. 8x8**

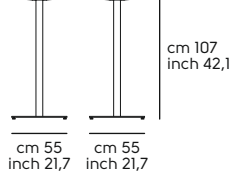

**Composit/2 H.107 Base 45x45 - Col. Ø 8**

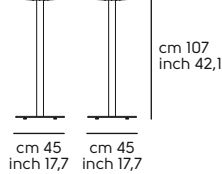

**Composit/2 H.107 Base 55x55 - Col. Ø 8**

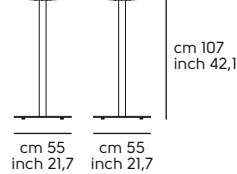

**Composit/3 H.107 Base Ø 45 - Col. Ø 8**

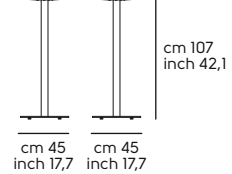



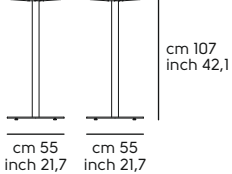

**Composit/3 H.107 Base Ø 55 - Col. Ø 8**



# Dama design Jacopo Maria Giagnoni

## Frame Dama





Frame in: metal Top NOT included

| Version   | Code     | H     | -- | Frame |       |       |       | Optional | Q.ty | boxes | Kg   | M <sup>3</sup> |
|---|----------|-------|----|-------|-------|-------|-------|----------|------|-------|------|----------------|
| <b>Dama Bistrot</b>   |          |       |    |       |       |       |       |          |      |       |      |                |
|   |          |       |    | M1    | M2    | O1    | O2    |          |      |       |      |                |
| <b>DAMA H.73</b><br>Top Max 80x80 - Ø 80<br>  | T2070B04 | H. 73 |    | 240 € | 267 € | 317 € | 344 € |          | 1    | 1     | 10.5 | 0.23           |
|    |          |       |    |       |       |       |       |          |      |       |      |                |
| <b>DAMA H.103</b><br>Top Max 80x80 - Ø 80<br> | T2070B04 | H.103 |    | 267 € | 294 € | 344 € | 371 € |          | 1    | 1     | 13.5 | 0.32           |
|    |          |       |    |       |       |       |       |          |      |       |      |                |

Note:

## Frame Dama

Frame in: metal Top NOT included

| Version  | Code      | H     | -- | Frame and Legs |       |  |  | Optional | Q.ty | boxes | Kg   | M <sup>3</sup> |
|--|-----------|-------|----|----------------|-------|--|--|----------|------|-------|------|----------------|
| <b>Dama Desk</b>   |           |       |    |                |       |  |  |          |      |       |      |                |
|  |           |       |    | M1             | M2    |  |  |          |      |       |      |                |
| <b>DAMA 140x80</b><br>       | T2070B140 | H. 73 |    | 470 €          | 536 € |  |  | 1        | 2    | 22.0  | 0.26 |                |
| <b>DAMA 160x80</b><br>       | T2070B160 | H. 73 |    | 495 €          | 561 € |  |  | 1        | 2    | 23.0  | 0.28 |                |
| <b>DAMA 200x100</b><br>      | T2070B200 | H. 73 |    | 580 €          | 646 € |  |  | 1        | 2    | 26.0  | 0.42 |                |
| <b>DAMA 140x80 H.110</b><br> | T2070B141 | H.110 |    | 495 €          | 561 € |  |  | 1        | 2    | 25.0  | 0.29 |                |

**DAMA 160x80 H.110**



T2070B161

H.110

520 €

586 €

1

2

26.0

0.31

**DAMA 200x100 H.110**



T2070B201

H.110

605 €

671 €

1

2

29.0

0.45

**Note:**

**Frame finishes**

**Metal**

**M1** WHITE **BB**, BROWN **E6**, SAND **EC**, WHITE PEARL **EF**, GRAPHITE **EG**, BLACK **EN**

**M2**

LIGHT BLUE **E0**, OCEAN BLUE **E1**, BRONZE **E2**, FANGO **E3**, PASTEL YELLOW **E4**, OCHER YELLOW **E7**, FACEPOWDER PINK **E8**, SAGE GREEN **E9**, PAPAYA ORANGE **EA**, BLUE SAPPHIRE **EE**, BLUE TURQUOISE **EH**, PINE GREEN **EJ**, DARK GREEN **EL**, GOLDEN YELLOW **EO**, CHERRY RED **EQ**, RED **ER**, ASH GREY **ES**, LIGHT GREY **ET**, BULGARRO RED **FP**

**Metal Outdoor**

**O1** Outdoor BROWN **E6**, Outdoor WHITE **BB**, Outdoor SAND **EC**, Outdoor WHITE PEARL **EF**, Outdoor GRAFITE **EG**, Outdoor BLACK **EN**

**O2**

Outdoor LIGHT BLUE **E0**, Outdoor OCEAN BLUE **E1**, Outdoor BRONZE **E2**, Outdoor FANGO **E3**, Outdoor PASTEL YELLOW **E4**, Outdoor OCHER YELLOW **E7**, Outdoor FACEPOWDER PINK **E8**, Outdoor SAGE GREEN **E9**, Outdoor BLUE SAPPHIRE **EE**, Outdoor BLUE TURQUOISE **EH**, Outdoor PINE GREEN **EJ**, Outdoor DARK GREEN **EL**, Outdoor GOLD YELLOW **EO**, Outdoor RED BULGARRO **FP**, Outdoor CHERRY RED **EQ**, Outdoor RED **ER**, Outdoor ASH GREY **ES**, Outdoor LIGHT GREY **ET**, Outdoor PAPAYA ORANGE **EA**

**Dama H. 73**



cm 68  
inch 26,8



cm 68  
inch 26,8

cm 73  
inch 28,7

**Dama H. 103**



cm 68  
inch 26,8



cm 68  
inch 26,8

cm 103  
inch 40,6

**Dama 140x80**



cm 130  
inch 51,2



cm 68  
inch 26,8

cm 73  
inch 28,7

**Dama 160x80**



cm 150  
inch 59,1



cm 68  
inch 26,8

cm 73  
inch 28,7

**Dama 200x100**



cm 190  
inch 74,8



cm 68  
inch 26,8

cm 73  
inch 28,7

**Dama 140x80 H.110**



cm 130  
inch 51,2



cm 68  
inch 26,8

cm 103  
inch 40,6

**Dama 160x80 H.110**



cm 150  
inch 59,1



cm 68  
inch 26,8

cm 103  
inch 40,6

**Dama 200x100 H.110**



cm 190  
inch 74,8





cm 68  
inch 26,8

cm 103  
inch 40,6

# Infinity design Officina delle Idee

## Frame Infinity

Frame in: metal Top NOT included

| Version   | Code     | H     | -- | Frame | Optional | G.ty  | boxes | Kg | M <sup>3</sup> |      |
|---|----------|-------|----|-------|----------|-------|-------|----|----------------|------|
| <b>Infinity</b>   |          |       |    |       |          |       |       |    |                |      |
|   |          |       |    | M1    | M2       | M3    |       |    |                |      |
| <b>INFINITY Base Ø 44 - Col. Ø 4</b><br>Top Ø60-Ø70-Ø80<br>   | T0190D44 | H. 73 |    | 330 € | 467 €    | 399 € | 1     | 1  | 7.5            | 0.19 |
| <b>INFINITY Base Ø 70 - Col. Ø 6</b><br>Top Ø90-Ø100-Ø120<br> | T0190D70 | H. 73 |    | 485 € | 622 €    | 554 € | 1     | 1  | 12             | 0.10 |

Note:

--

### Frame finishes

#### Metal

|           |   |           |  |
|-----------|---|-----------|--|
| <b>M1</b> | WHITE <b>BB</b> , BROWN <b>E6</b> , SAND <b>EC</b> , WHITE PEARL <b>EF</b> , GRAPHITE <b>EG</b> , BLACK <b>EN</b> | <b>M2</b> | LIGHT BLUE <b>E0</b> , OCEAN BLUE <b>E1</b> , BRONZE <b>E2</b> , FANGO <b>E3</b> , PASTEL YELLOW <b>E4</b> , OCHER YELLOW <b>E7</b> , FACEPOWDER PINK <b>E8</b> , SAGE GREEN <b>E9</b> , PAPAYA ORANGE <b>EA</b> , BLUE SAPPHIRE <b>EE</b> , BLUE TURQUOISE <b>EH</b> , PINE GREEN <b>EJ</b> , DARK GREEN <b>EL</b> , GOLDEN YELLOW <b>EO</b> , CHERRY RED <b>EQ</b> , RED <b>ER</b> , ASH GREY <b>ES</b> , LIGHT GREY <b>ET</b> , BULGARO RED <b>FP</b> |
| <b>M3</b> | CHROME <b>CC</b>  |           |  |

#### INFINITY H.73 Base Ø 44 - Col. Ø 4

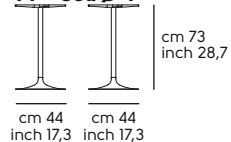

#### INFINITY H.73 Base Ø 70 - Col. Ø 6

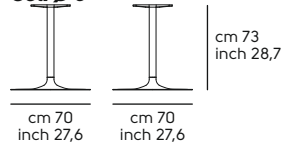



B  
A  
S  
E  
S

# Liù design Archirivolto

## Frame Liù

Frame in: metal - wood Top NOT included

| Version  | Code     | H     | Legs | Metal Insert |       | Optional | G.ty | boxes | Kg  | M <sup>3</sup> |
|--|----------|-------|------|--------------|-------|----------|------|-------|-----|----------------|
| <b>Liù</b>   |          |       |      |              |       |          |      |       |     |                |
|  |          |       |      | M1           | M2    |          |      |       |     |                |
| <b>LIU' ML H 73</b><br>Top Max 70x70 - Ø 80<br> | T1285B04 | H. 73 | LF1  | 253 €        | 291 € | PD-F0    | 1    | 1     | 6.7 | 0.21           |
| <b>LIU' ML GEO H 40</b><br>Top 120x50<br>       | T1285B14 | H. 40 | LF1  | 261 €        | 317 € | PD-F0    | 1    | 1     | 8   | 0.24           |
| <b>LIU' ML GEO H 50</b><br>Top 120x50<br>     | T1285B14 | H. 50 | LF1  | 269 €        | 325 € | PD-F0    | 1    | 1     | 9   | 0.28           |

### Legs finishes

#### Wood

##### LF1

Ash wood stained BLACK **F04**, Ash wood stained WHITE **F05**, Ash wood stained CHERRY RED **F09**, Ash wood stained FLAMED WALNUT **F24**, Ash wood stained DARK BROWN **F26**, Ash wood stained NATURAL **F40**, Ash wood stained NATURAL OAK **F52**, Ash wood stained WHITENED **F60**, Ash wood stained DESERT **F61**, Ash wood stained LIGHT GREY **F62**, Ash wood stained DARK GREY **F63**

### Insert finishes

#### Metal

##### M1

WHITE **BB**, BROWN **E6**, SAND **EC**, WHITE PEARL **EF**, GRAPHITE **EG**, BLACK **EN**

##### M2

LIGHT BLUE **E0**, OCEAN BLUE **E1**, BRONZE **E2**, FANGO **E3**, PASTEL YELLOW **E4**, OCHER YELLOW **E7**, FACEPOWDER PINK **E8**, SAGE GREEN **E9**, PAPAYA ORANGE **EA**, BLUE SAPPHIRE **EE**, BLUE TURQUOISE **EH**, PINE GREEN **EJ**, DARK GREEN **EL**, GOLDEN YELLOW **EO**, CHERRY RED **EQ**, RED **ER**, ASH GREY **ES**, LIGHT GREY **ET**, BULGARO RED **FP**

### Optionals:

|              | Value         | Options/notes |
|--------------|---------------|---------------|
| <b>PD-F0</b> | Felt pad feet | + 6 € PD-F0   |

#### Liù ML H 73

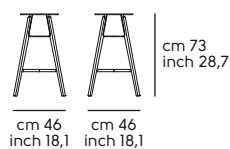

#### Liù ML GEO H 40

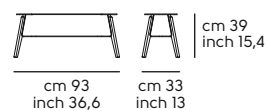



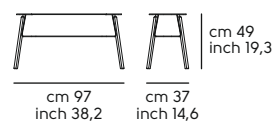

#### Liù ML GEO H 50



# Luna design Paolo Vernier

## Frame Luna

Frame in: metal Top NOT included

| Version  | Code     | H     | -- | Frame |       |       |       | Optional | G.ty | boxes | Kg   | M <sup>3</sup> |
|--|----------|-------|----|-------|-------|-------|-------|----------|------|-------|------|----------------|
| <b>Luna</b>  |          |       |    |       |       |       |       |          |      |       |      |                |
|  |          |       |    | M1    | M2    | O1    | O2    |          |      |       |      |                |
| <b>LUNA Base 52x52</b><br>Top Max 80x80 - Ø 80<br>  | T0311B40 | H. 73 |    | 227 € | 240 € | 265 € | 288 € | 1        | 1    | 7     | 0.10 |                |
| <b>LUNA Base 52x52</b><br>Top Max 80x80 - Ø 80<br>  | T0311B40 | H.103 |    | 244 € | 257 € | 282 € | 305 € | 1        | 1    | 8     | 0.14 |                |

### Frame finishes

#### Metal

|           |  |
|-----------|--|
| <b>M1</b> | WHITE <b>BB</b> , BROWN <b>E6</b> , SAND <b>EC</b> , WHITE PEARL <b>EF</b> , GRAPHITE <b>EG</b> , BLACK <b>EN</b>  |
| <b>M2</b> | LIGHT BLUE <b>E0</b> , OCEAN BLUE <b>E1</b> , BRONZE <b>E2</b> , FANGO <b>E3</b> , PASTEL YELLOW <b>E4</b> , OCHER YELLOW <b>E7</b> , FACEPOWDER PINK <b>E8</b> , SAGE GREEN <b>E9</b> , PAPAYA ORANGE <b>EA</b> , BLUE SAPPHIRE <b>EE</b> , BLUE TURQUOISE <b>EH</b> , PINE GREEN <b>EJ</b> , DARK GREEN <b>EL</b> , GOLDEN YELLOW <b>EO</b> , CHERRY RED <b>EQ</b> , RED <b>ER</b> , ASH GREY <b>ES</b> , LIGHT GREY <b>ET</b> , BULGARO RED <b>FP</b> |

#### Metal Outdoor

|           |  |
|-----------|--|
| <b>O1</b> | Outdoor BROWN <b>E6</b> , Outdoor WHITE <b>BB</b> , Outdoor SAND <b>EC</b> , Outdoor WHITE PEARL <b>EF</b> , Outdoor GRAFITE <b>EG</b> , Outdoor BLACK <b>EN</b>   |
| <b>O2</b> | Outdoor LIGHT BLUE <b>E0</b> , Outdoor OCEAN BLUE <b>E1</b> , Outdoor BRONZE <b>E2</b> , Outdoor FANGO <b>E3</b> , Outdoor PASTEL YELLOW <b>E4</b> , Outdoor OCHER YELLOW <b>E7</b> , Outdoor FACEPOWDER PINK <b>E8</b> , Outdoor SAGE GREEN <b>E9</b> , Outdoor BLUE SAPPHIRE <b>EE</b> , Outdoor BLUE TURQUOISE <b>EH</b> , Outdoor PINE GREEN <b>EJ</b> , Outdoor DARK GREEN <b>EL</b> , Outdoor GOLD YELLOW <b>EO</b> , Outdoor RED BULGARO <b>FP</b> , Outdoor CHERRY RED <b>EQ</b> , Outdoor RED <b>ER</b> , Outdoor ASH GREY <b>ES</b> , Outdoor LIGHT GREY <b>ET</b> , Outdoor PAPAYA ORANGE <b>EA</b> |

#### Luna H. 73

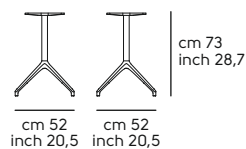



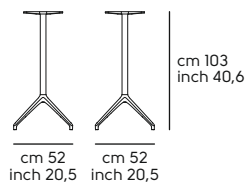

#### Luna H. 103



# Ola design Paolo Vernier

## Frame Ola

Frame in: metal Top NOT included

| Version   | Code     | H     | -- | Frame | Optional | G.ty  | boxes | Kg | M <sup>3</sup> |     |      |
|---|----------|-------|----|-------|----------|-------|-------|----|----------------|-----|------|
| <b>Ola</b>  |          |       |    |       |          |       |       |    |                |     |      |
| <b>OLA/3 H 73</b><br>Top Max Ø90-Min Ø70  |          |       |    | M1    | M2       | O1    | O2    |    |                |     |      |
|  | T1400B03 | H. 73 |    | 138 € | 154 €    | 182 € | 203 € | 1  | 1              | 4.5 | 0.25 |
|  |          |       |    |       |          |       |       |    |                |     |      |
| <b>OLA/4 H 73</b><br>Top Max 90x90-Min 75x75                                      |          |       |    |       |          |       |       |    |                |     |      |
|  | T1400B04 | H. 73 |    | 201 € | 224 €    | 268 € | 289 € | 1  | 1              | 6.5 | 0.39 |
|  |          |       |    |       |          |       |       |    |                |     |      |

### Frame finishes

#### Metal

|           |  |
|-----------|--|
| <b>M1</b> | WHITE <b>BB</b> , INDUSTRIAL <b>E5</b> , BROWN <b>E6</b> , SAND <b>EC</b> , WHITE PEARL <b>EF</b> , GRAPHITE <b>EG</b> , BLACK <b>EN</b>   |
| <b>M2</b> | LIGHT BLUE <b>E0</b> , OCEAN BLUE <b>E1</b> , BRONZE <b>E2</b> , FANGO <b>E3</b> , PASTEL YELLOW <b>E4</b> , OCHER YELLOW <b>E7</b> , FACEPOWDER PINK <b>E8</b> , SAGE GREEN <b>E9</b> , PAPAYA ORANGE <b>EA</b> , BLUE SAPPHIRE <b>EE</b> , BLUE TURQUOISE <b>EH</b> , PINE GREEN <b>EJ</b> , DARK GREEN <b>EL</b> , GOLDEN YELLOW <b>EO</b> , CHERRY RED <b>EQ</b> , RED <b>ER</b> , ASH GREY <b>ES</b> , LIGHT GREY <b>ET</b> , BULGARO RED <b>FP</b> |

#### Metal Outdoor

|           |  |
|-----------|--|
| <b>O1</b> | Outdoor BROWN <b>E6</b> , Outdoor WHITE <b>BB</b> , Outdoor SAND <b>EC</b> , Outdoor WHITE PEARL <b>EF</b> , Outdoor GRAFITE <b>EG</b> , Outdoor BLACK <b>EN</b>   |
| <b>O2</b> | Outdoor LIGHT BLUE <b>E0</b> , Outdoor OCEAN BLUE <b>E1</b> , Outdoor BRONZE <b>E2</b> , Outdoor FANGO <b>E3</b> , Outdoor PASTEL YELLOW <b>E4</b> , Outdoor OCHER YELLOW <b>E7</b> , Outdoor FACEPOWDER PINK <b>E8</b> , Outdoor SAGE GREEN <b>E9</b> , Outdoor BLUE SAPPHIRE <b>EE</b> , Outdoor BLUE TURQUOISE <b>EH</b> , Outdoor PINE GREEN <b>EJ</b> , Outdoor DARK GREEN <b>EL</b> , Outdoor GOLD YELLOW <b>EO</b> , Outdoor RED BULGARO <b>FP</b> , Outdoor CHERRY RED <b>EQ</b> , Outdoor RED <b>ER</b> , Outdoor ASH GREY <b>ES</b> , Outdoor LIGHT GREY <b>ET</b> , Outdoor PAPAYA ORANGE <b>EA</b> |

#### Ola/3 H 73

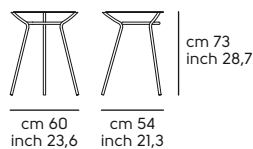



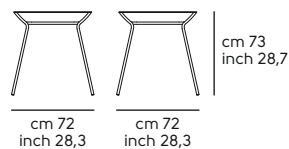





#### Ola/4 H 73



# Plissé design Paola Navone



## Frame Plissé

Frame in: metal Top NOT included

| Version  | Code      | H     | -- | Frame   |         |         |         | Optional | Q.ty | boxes | Kg   | M <sup>3</sup> |
|--|-----------|-------|----|---------|---------|---------|---------|----------|------|-------|------|----------------|
| <b>Plissé</b>  |           |       |    |         |         |         |         |          |      |       |      |                |
|  |           |       |    | M1      | M2      | O1      | O2      |          |      |       |      |                |
| <b>PLISSÉ</b><br>Top Ø 60-70-80-90   |           |       |    |         |         |         |         |          |      |       |      |                |
|    | T2220BT0  | H. 73 |    | 863 €   | 946 €   | 951 €   | 1.034 € |          | 1    | 1     | 25   | 0.17           |
|   |           |       |    |         |         |         |         |          |      |       |      |                |
| <b>PLISSÉ</b><br>Top Ø 60-70   |           |       |    |         |         |         |         |          |      |       |      |                |
|    | T2220BT0  | H.103 |    | 983 €   | 1.066 € | 1.071 € | 1.154 € |          | 1    | 1     | 27.5 | 0.24           |
|   |           |       |    |         |         |         |         |          |      |       |      |                |
| Version  | Code      | H     | -- | Frame   |         |         |         | Optional | Q.ty | boxes | Kg   | M <sup>3</sup> |
|  |           |       |    | M1      | M2      |         |         |          |      |       |      |                |
| <b>PLISSÉ Ø100-120</b><br>Top Ø 100-120  |           |       |    |         |         |         |         |          |      |       |      |                |
|  | T2220B120 | H. 73 |    | 1.154 € |         | 1.238 € |         |          | 1    | 2     | 42.5 | 0.27           |
| <b>PLISSÉ Ø150</b><br>Top Ø 150-180  |           |       |    |         |         |         |         |          |      |       |      |                |
|  | T2220B150 | H. 73 |    | 1.872 € |         | 1.997 € |         |          | 1    | 2     | 59   | 0.51           |
| <b>PLISSÉ Elliptical 220</b>   |           |       |    |         |         |         |         |          |      |       |      |                |
|  | T2220B220 | H. 73 |    | 2.440 € |         | 2.630 € |         |          | 1    | 1     | 105  | 0.85           |
| <b>PLISSÉ Elliptical 250</b>   |           |       |    |         |         |         |         |          |      |       |      |                |
|  | T2220B250 | H. 73 |    | 2.440 € |         | 2.630 € |         |          | 1    | 1     | 114  | 0.85           |

## Frame Plissé INOX

Frame in: inox Top NOT included

| Version  | Code      | H     | -- | Frame   | Optional | Q.ty | boxes | Kg   | M²   |
|--|-----------|-------|----|---------|----------|------|-------|------|------|
| <b>Plissé</b>  |           |       |    |         |          |      |       |      |      |
|  |           |       |    | M1      | M2       |      |       |      |      |
| <b>PLISSÉ Ø100-120</b><br>Top Ø 100-120<br> | T2220B121 | H. 73 |    | 1.422 € | 1.506 €  | 1    | 2     | 42.5 | 0.27 |
| <b>PLISSÉ Ø150</b><br>Top Ø 150-180<br>     | T2220B151 | H. 73 |    | 1.995 € | 2.120 €  | 1    | 2     | 59   | 0.51 |

Note:

--

### Frame finishes

#### Metal

|           |   |
|-----------|---|
| <b>M1</b> | WHITE <b>BB</b> , BROWN <b>E6</b> , SAND <b>EC</b> , WHITE PEARL <b>EF</b> , GRAPHITE <b>EG</b> , BLACK <b>EN</b>   |
| <b>M2</b> | LIGHT BLUE <b>E0</b> , OCEAN BLUE <b>E1</b> , FANGO <b>E3</b> , PASTEL YELLOW <b>E4</b> , OCHER YELLOW <b>E7</b> , FACEPOWDER PINK <b>E8</b> , SAGE GREEN <b>E9</b> , PAPAYA ORANGE <b>EA</b> , BLUE SAPPHIRE <b>EE</b> , BLUE TURQUOISE <b>EH</b> , PINE GREEN <b>EJ</b> , DARK GREEN <b>EL</b> , GOLDEN YELLOW <b>EO</b> , CHERRY RED <b>EQ</b> , RED <b>ER</b> , ASH GREY <b>ES</b> , LIGHT GREY <b>ET</b> , BRONZE <b>EZ</b> + TRANSP., BULGARO RED <b>FP</b> |

#### Metal Outdoor

|           |  |
|-----------|--|
| <b>O1</b> | Outdoor BROWN <b>E6</b> , Outdoor WHITE <b>BB</b> , Outdoor SAND <b>EC</b> , Outdoor WHITE PEARL <b>EF</b> , Outdoor GRAPHITE <b>EG</b> , Outdoor BLACK <b>EN</b>  |
| <b>O2</b> | Outdoor LIGHT BLUE <b>E0</b> , Outdoor OCEAN BLUE <b>E1</b> , Outdoor BRONZE <b>E2</b> , Outdoor FANGO <b>E3</b> , Outdoor PASTEL YELLOW <b>E4</b> , Outdoor OCHER YELLOW <b>E7</b> , Outdoor FACEPOWDER PINK <b>E8</b> , Outdoor SAGE GREEN <b>E9</b> , Outdoor BLUE SAPPHIRE <b>EE</b> , Outdoor BLUE TURQUOISE <b>EH</b> , Outdoor PINE GREEN <b>EJ</b> , Outdoor DARK GREEN <b>EL</b> , Outdoor GOLD YELLOW <b>EO</b> , Outdoor RED BULGARO <b>FP</b> , Outdoor CHERRY RED <b>EQ</b> , Outdoor RED <b>ER</b> , Outdoor ASH GREY <b>ES</b> , Outdoor LIGHT GREY <b>ET</b> , Outdoor PAPAYA ORANGE <b>EA</b> |

#### Plissé H. 73

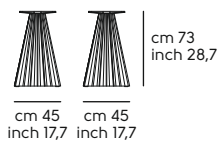

#### Plissé H. 103

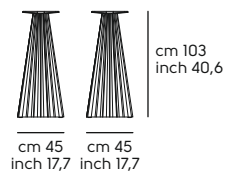

#### Plissé D.100-120

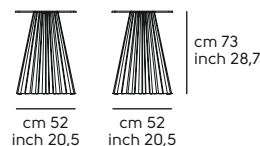

#### Plissé D.150

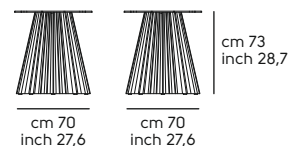

#### Plissé Elliptical 220

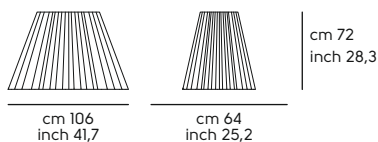



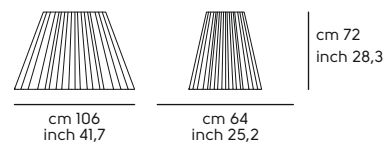



#### Plissé Elliptical 250

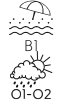

# Smart design Officina delle Idee

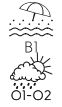
## Frame Smart 1 / 2

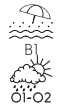
Frame in: metal Top NOT included

| Version  | Code     | H     | -- | Base and Column |       |       |       |       | Optional | Q.ty | boxes | Kg | M <sup>3</sup> |
|--|----------|-------|----|-----------------|-------|-------|-------|-------|----------|------|-------|----|----------------|
| <b>Smart H. 73</b>   |          |       |    |                 |       |       |       |       |          |      |       |    |                |
|  |          |       |    | M1              | M2    | M5    | O1    | B1    |          |      |       |    |                |
| <b>SMART/1 Base 39x39 - Col. 6x6</b><br>Top Max 70x70 - Ø 80   |          |       |    |                 |       |       |       |       |          |      |       |    |                |
|       | TI504Q39 | H. 73 |    | 179 €           | 199 € | 226 € | 235 € | 278 € |          | 1    | 3     | 21 | 0.04           |
| <b>SMART/1 Base 48x48 - Col. 6x6</b><br>Top Max 80x80 - Ø 90   |          |       |    |                 |       |       |       |       |          |      |       |    |                |
|       | TI504Q48 | H. 73 |    | 235 €           | 257 € | 300 € | 312 € | 348 € |          | 1    | 3     | 25 | 0.04           |
| <b>SMART/2 Base Ø 42 - Col. Ø 6</b><br>Top Max 70x70 - Ø 70  |          |       |    |                 |       |       |       |       |          |      |       |    |                |
|   | TI505D42 | H. 73 |    | 156 €           | 177 € | 198 € | 209 € | 253 € |          | 1    | 3     | 23 | 0.05           |
| <b>SMART/2 Base Ø 50 - Col. Ø 6</b><br>Top Max 70x70 - Ø 90  |          |       |    |                 |       |       |       |       |          |      |       |    |                |
|   | TI505D50 | H. 73 |    | 183 €           | 205 € | 238 € | 268 € | 283 € |          | 1    | 3     | 27 | 0.05           |

### Base and Column Finishes

#### Metal

|           |   |
|-----------|---|
| <b>M1</b> | WHITE <b>BB</b> , INDUSTRIAL <b>E5</b> , BROWN <b>E6</b> , SAND <b>EC</b> , GRAPHITE <b>EG</b> , BLACK <b>EN</b>  |
| <b>M2</b> | LIGHT BLUE <b>E0</b> , OCEAN BLUE <b>E1</b> , BRONZE <b>E2</b> , FANGO <b>E3</b> , PASTEL YELLOW <b>E4</b> , OCHER YELLOW <b>E7</b> , FACEPOWDER PINK <b>E8</b> , SAGE GREEN <b>E9</b> , PAPAYA ORANGE <b>EA</b> , PINE GREEN <b>EJ</b> , DARK GREEN <b>EL</b> , GOLDEN YELLOW <b>EO</b> , CHERRY RED <b>EQ</b> , RED <b>ER</b> , ASH GREY <b>ES</b> , LIGHT GREY <b>ET</b> , BULGARO RED <b>FP</b> |
| <b>M5</b> | SATIN STAINLESS STEEL <b>HS</b>   |

#### Metal Outdoor

|           |   |
|-----------|---|
| <b>O1</b> | Outdoor WHITE <b>BB</b> , Outdoor BLACK <b>EN</b> |
|-----------|---|

#### Seaside Zone Metal

|           |   |
|-----------|---|
| <b>B1</b> | Bathing area WHITE <b>NB</b> , Bathing area BLACK <b>NN</b> |
|-----------|---|

**Smart/1 H. 73 Base 39x39 - Col. 6x6**

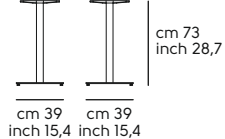

**Smart/1 H. 73 Base 48x48 - Col. 6x6**

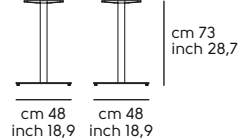

**Smart/2 H. 73 Base Ø 42 - Col. Ø 6**

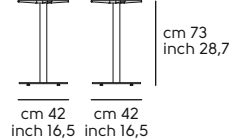



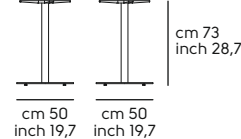



**Smart/2 H. 73 Base Ø 50 - Col. Ø 6**

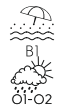

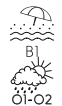
| Version | Code | H | -- | Base and Column | Optional | Q.ty | boxes | Kg | M <sup>3</sup> |
|---------|------|---|----|-----------------|----------|------|-------|----|----------------|
|---------|------|---|----|-----------------|----------|------|-------|----|----------------|

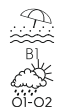
**Smart H.107**

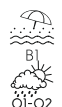
|  |          |       | M1    | M2    | M5    | O1    | B1    |   |   |    |      |
|--|----------|-------|-------|-------|-------|-------|-------|---|---|----|------|
| <b>SMART/1 Base 39x39 - Col. 6x6</b><br>Top Max 70x70 - Ø 70<br>   | T1504Q39 | H.107 | 206 € | 226 € | 253 € | 262 € | 305 € | 1 | 3 | 23 | 0.04 |
| <b>SMART/1 Base 48x48 - Col. 6x6</b><br>Top Max 70x70 - Ø 70<br>   | T1504Q48 | H.107 | 262 € | 284 € | 327 € | 339 € | 375 € | 1 | 3 | 27 | 0.04 |
| <b>SMART/2 Base Ø 42 - Col. Ø 6</b><br>Top Max 70x70 - Ø 70<br>    | T1505D42 | H.107 | 183 € | 204 € | 225 € | 236 € | 280 € | 1 | 3 | 25 | 0.05 |
| <b>SMART/2 Base Ø 50 - Col. Ø 6</b><br>Top Max 70x70 - Ø 70<br>  | T1505D50 | H.107 | 210 € | 232 € | 265 € | 295 € | 310 € | 1 | 3 | 29 | 0.05 |

**Base and Column Finishes**

**Metal**

|           |   |
|-----------|---|
| <b>M1</b> | WHITE <b>BB</b> , INDUSTRIAL <b>E5</b> , BROWN <b>E6</b> , SAND <b>EC</b> , GRAPHITE <b>EG</b> , BLACK <b>EN</b>  |
| <b>M2</b> | LIGHT BLUE <b>E0</b> , OCEAN BLUE <b>E1</b> , BRONZE <b>E2</b> , FANGO <b>E3</b> , PASTEL YELLOW <b>E4</b> , OCHER YELLOW <b>E7</b> , FACEPOWDER PINK <b>E8</b> , SAGE GREEN <b>E9</b> , PAPAYA ORANGE <b>EA</b> , PINE GREEN <b>EJ</b> , DARK GREEN <b>EL</b> , GOLDEN YELLOW <b>EO</b> , CHERRY RED <b>EQ</b> , RED <b>ER</b> , ASH GREY <b>ES</b> , LIGHT GREY <b>ET</b> , BULGARO RED <b>FP</b> |
| <b>M5</b> | SATIN STAINLESS STEEL <b>HS</b>   |

**Metal Outdoor**

|           |   |
|-----------|---|
| <b>O1</b> | Outdoor WHITE <b>BB</b> , Outdoor BLACK <b>EN</b> |
|-----------|---|

**Seaside Zone Metal**

|           |   |
|-----------|---|
| <b>B1</b> | Bathing area WHITE <b>NB</b> , Bathing area BLACK <b>NN</b> |
|-----------|---|

**Smart/1 H.107 Base 39x39 - Col. 6x6**

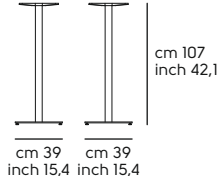

**Smart/1 H.107 Base 48x48 - Col. 6x6**

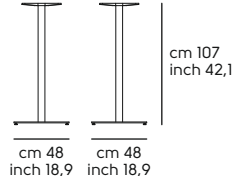

**Smart/2 H.107 Base Ø 42 - Col. Ø 6**

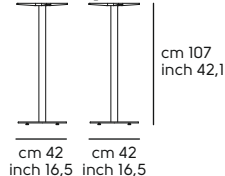



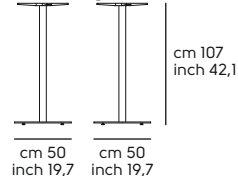



**Smart/2 H.107 Base Ø 50 - Col. Ø 6**



# Square design Balutto Associati

## Frame Square

Frame in: metal Top NOT included

| Version   | Code     | H     | -- | Frame |       |       |       | Optional | G.ty | boxes | Kg | M <sup>3</sup> |
|---|----------|-------|----|-------|-------|-------|-------|----------|------|-------|----|----------------|
| <b>Square H. 73</b>   |          |       |    |       |       |       |       |          |      |       |    |                |
|   |          |       |    | M1    | M2    | O1    | O2    |          |      |       |    |                |
| <b>SQUARE 3G H 73</b><br>Top Max Ø 80<br>              | T1900B03 | H. 73 | -- | 215 € | 243 € | 260 € | 286 € |          | 1    | 1     | 7  | 0.28           |
| <b>SQUARE 3G H 73 Folding</b><br>Top Max Ø 80<br>      | T1900BR3 | H. 73 | -- | 249 € | 276 € | 295 € | 342 € |          | 1    | 1     | 7  | 0.28           |
| <b>SQUARE 4G H 73</b><br>Top Max 80x80 - Ø 80<br>  | T1900B04 | H. 73 | -- | 243 € | 269 € | 286 € | 304 € |          | 1    | 1     | 8  | 0.28           |

### Frame finishes

#### Metal

|           |  |
|-----------|--|
| <b>M1</b> | WHITE <b>BB</b> , BROWN <b>E6</b> , SAND <b>EC</b> , WHITE PEARL <b>EF</b> , GRAPHITE <b>EG</b> , BLACK <b>EN</b>  |
| <b>M2</b> | LIGHT BLUE <b>E0</b> , OCEAN BLUE <b>E1</b> , BRONZE <b>E2</b> , FANGO <b>E3</b> , PASTEL YELLOW <b>E4</b> , OCHER YELLOW <b>E7</b> , FACEPOWDER PINK <b>E8</b> , SAGE GREEN <b>E9</b> , PAPAYA ORANGE <b>EA</b> , BLUE SAPPHIRE <b>EE</b> , BLUE TURQUOISE <b>EH</b> , PINE GREEN <b>EJ</b> , DARK GREEN <b>EL</b> , GOLDEN YELLOW <b>EO</b> , CHERRY RED <b>EQ</b> , RED <b>ER</b> , ASH GREY <b>ES</b> , LIGHT GREY <b>ET</b> , BULGARO RED <b>FP</b> |

#### Metal Outdoor

|           |  |
|-----------|--|
| <b>O1</b> | Outdoor BROWN <b>E6</b> , Outdoor WHITE <b>BB</b> , Outdoor SAND <b>EC</b> , Outdoor WHITE PEARL <b>EF</b> , Outdoor GRAFITE <b>EG</b> , Outdoor BLACK <b>EN</b>   |
| <b>O2</b> | Outdoor LIGHT BLUE <b>E0</b> , Outdoor OCEAN BLUE <b>E1</b> , Outdoor BRONZE <b>E2</b> , Outdoor FANGO <b>E3</b> , Outdoor PASTEL YELLOW <b>E4</b> , Outdoor OCHER YELLOW <b>E7</b> , Outdoor FACEPOWDER PINK <b>E8</b> , Outdoor SAGE GREEN <b>E9</b> , Outdoor BLUE SAPPHIRE <b>EE</b> , Outdoor BLUE TURQUOISE <b>EH</b> , Outdoor PINE GREEN <b>EJ</b> , Outdoor DARK GREEN <b>EL</b> , Outdoor GOLD YELLOW <b>EO</b> , Outdoor RED BULGARO <b>FP</b> , Outdoor CHERRY RED <b>EQ</b> , Outdoor RED <b>ER</b> , Outdoor ASH GREY <b>ES</b> , Outdoor LIGHT GREY <b>ET</b> , Outdoor PAPAYA ORANGE <b>EA</b> |

#### Square 3G H 73

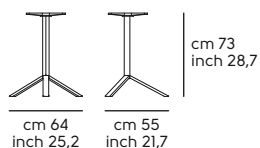

#### Square 3G H 73 Folding

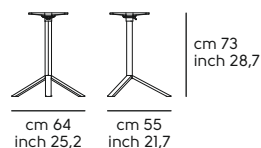



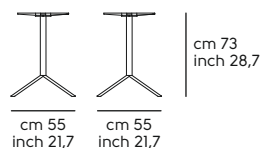



#### Square 4G H 73



| Version | Code | H | -- | Frame | Optional | Q.ty | boxes | Kg | M <sup>2</sup> |
|---------|------|---|----|-------|----------|------|-------|----|----------------|
|---------|------|---|----|-------|----------|------|-------|----|----------------|

**Square H.107**

|   |          |       | M1 | M2 | O1 | O2 |  |  |  |  |
|---|----------|-------|----|----|----|----|--|--|--|--|
| <b>SQUARE 3G H 107</b><br>Top Max Ø 70<br>          | T1900B03 | H.107 |    |    |    |    |  |  |  |  |
| <b>SQUARE 3G H 107 Folding</b><br>Top Max Ø 70<br>  | T1900BR3 | H.107 |    |    |    |    |  |  |  |  |
| <b>SQUARE 4G H 107</b><br>Top Max 70x70 - Ø 70<br>  | T1900B04 | H.107 |    |    |    |    |  |  |  |  |

**Frame finishes**

**Metal**

|           |  |
|-----------|--|
| <b>M1</b> | WHITE <b>BB</b> , BROWN <b>E6</b> , SAND <b>EC</b> , WHITE PEARL <b>EF</b> , GRAPHITE <b>EG</b> , BLACK <b>EN</b>  |
| <b>M2</b> | LIGHT BLUE <b>E0</b> , OCEAN BLUE <b>E1</b> , BRONZE <b>E2</b> , FANGO <b>E3</b> , PASTEL YELLOW <b>E4</b> , OCHER YELLOW <b>E7</b> , FACEPOWDER PINK <b>E8</b> , SAGE GREEN <b>E9</b> , PAPAYA ORANGE <b>EA</b> , BLUE SAPPHIRE <b>EE</b> , BLUE TURQUOISE <b>EH</b> , PINE GREEN <b>EJ</b> , DARK GREEN <b>EL</b> , GOLDEN YELLOW <b>EO</b> , CHERRY RED <b>EQ</b> , RED <b>ER</b> , ASH GREY <b>ES</b> , LIGHT GREY <b>ET</b> , BULGARO RED <b>FP</b> |

**Metal Outdoor**

|           |  |
|-----------|--|
| <b>O1</b> | Outdoor BROWN <b>E6</b> , Outdoor WHITE <b>BB</b> , Outdoor SAND <b>EC</b> , Outdoor WHITE PEARL <b>EF</b> , Outdoor GRAFITE <b>EG</b> , Outdoor BLACK <b>EN</b>   |
| <b>O2</b> | Outdoor LIGHT BLUE <b>E0</b> , Outdoor OCEAN BLUE <b>E1</b> , Outdoor BRONZE <b>E2</b> , Outdoor FANGO <b>E3</b> , Outdoor PASTEL YELLOW <b>E4</b> , Outdoor OCHER YELLOW <b>E7</b> , Outdoor FACEPOWDER PINK <b>E8</b> , Outdoor SAGE GREEN <b>E9</b> , Outdoor BLUE SAPPHIRE <b>EE</b> , Outdoor BLUE TURQUOISE <b>EH</b> , Outdoor PINE GREEN <b>EJ</b> , Outdoor DARK GREEN <b>EL</b> , Outdoor GOLD YELLOW <b>EO</b> , Outdoor RED BULGARO <b>FP</b> , Outdoor CHERRY RED <b>EQ</b> , Outdoor RED <b>ER</b> , Outdoor ASH GREY <b>ES</b> , Outdoor LIGHT GREY <b>ET</b> , Outdoor PAPAYA ORANGE <b>EA</b> |

**Square 3G H 107**

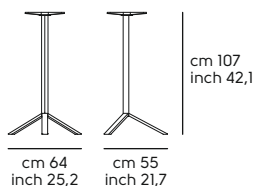

**Square 3G H 107 Folding**

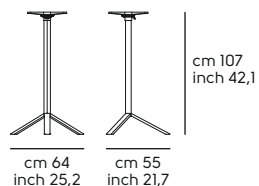

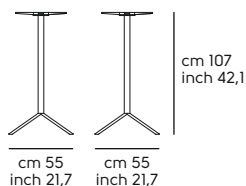

**Square 4G H 107**



# Trampoliere design Roberto Paoli

## Frame Trampoliere

Frame in: metal Top NOT included

| Version  | Code     | H     | -- | Frame |       |       |       | Optional | G.ty | boxes | Kg   | M <sup>3</sup> |
|--|----------|-------|----|-------|-------|-------|-------|----------|------|-------|------|----------------|
| <b>Trampoliere</b>   |          |       |    |       |       |       |       |          |      |       |      |                |
|  |          |       |    | M1    | M2    | O1    | O2    |          |      |       |      |                |
| <b>TRAMPOLIERE H 73</b><br>Top Max Ø 80<br>  | T1550B3G | H. 73 |    | 152 € | 171 € | 192 € | 209 € |          | 1    | 2     | 10.5 | 0.31           |
| <b>TRAMPOLIERE H 107</b><br>Top Max Ø 70<br> | T1550B3G | H.107 |    | 171 € | 190 € | 211 € | 228 € |          | 1    | 2     | 11.5 | 0.44           |

## Frame finishes

### Metal

|           |  |
|-----------|--|
| <b>M1</b> | WHITE <b>BB</b> , BROWN <b>E6</b> , SAND <b>EC</b> , WHITE PEARL <b>EF</b> , GRAPHITE <b>EG</b> , BLACK <b>EN</b>  |
| <b>M2</b> | LIGHT BLUE <b>E0</b> , OCEAN BLUE <b>E1</b> , BRONZE <b>E2</b> , FANGO <b>E3</b> , PASTEL YELLOW <b>E4</b> , OCHER YELLOW <b>E7</b> , FACEPOWDER PINK <b>E8</b> , SAGE GREEN <b>E9</b> , PAPAYA ORANGE <b>EA</b> , BLUE SAPPHIRE <b>EE</b> , BLUE TURQUOISE <b>EH</b> , PINE GREEN <b>EJ</b> , DARK GREEN <b>EL</b> , GOLDEN YELLOW <b>EO</b> , CHERRY RED <b>EQ</b> , RED <b>ER</b> , ASH GREY <b>ES</b> , LIGHT GREY <b>ET</b> , BULGARO RED <b>FP</b> |

### Metal Outdoor

|           |  |
|-----------|--|
| <b>O1</b> | Outdoor BROWN <b>E6</b> , Outdoor WHITE <b>BB</b> , Outdoor SAND <b>EC</b> , Outdoor WHITE PEARL <b>EF</b> , Outdoor GRAFITE <b>EG</b> , Outdoor BLACK <b>EN</b>   |
| <b>O2</b> | Outdoor LIGHT BLUE <b>E0</b> , Outdoor OCEAN BLUE <b>E1</b> , Outdoor BRONZE <b>E2</b> , Outdoor FANGO <b>E3</b> , Outdoor PASTEL YELLOW <b>E4</b> , Outdoor OCHER YELLOW <b>E7</b> , Outdoor FACEPOWDER PINK <b>E8</b> , Outdoor SAGE GREEN <b>E9</b> , Outdoor BLUE SAPPHIRE <b>EE</b> , Outdoor BLUE TURQUOISE <b>EH</b> , Outdoor PINE GREEN <b>EJ</b> , Outdoor DARK GREEN <b>EL</b> , Outdoor GOLD YELLOW <b>EO</b> , Outdoor RED BULGARO <b>FP</b> , Outdoor CHERRY RED <b>EQ</b> , Outdoor RED <b>ER</b> , Outdoor ASH GREY <b>ES</b> , Outdoor LIGHT GREY <b>ET</b> , Outdoor PAPAYA ORANGE <b>EA</b> |

### Trampoliere H. 73

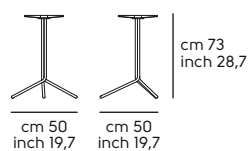

### Trampoliere H.107

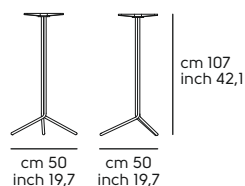



Top

# Top design Officina delle Idee

## Top Glass

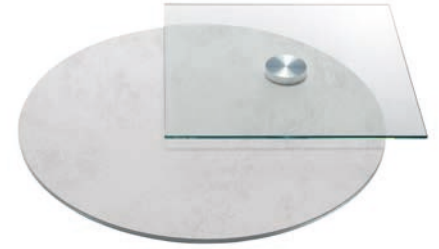

| Version | Code | Thickness | Finish | Optional | Q.ty | boxes | Kg | M <sup>3</sup> |
|---------|------|-----------|--------|----------|------|-------|----|----------------|
|---------|------|-----------|--------|----------|------|-------|----|----------------|

### Round glass top with 1 fixing

|          |          |     |  | GVB   |   |   |      |      |
|----------|----------|-----|--|-------|---|---|------|------|
| Top Ø 60 | TT10VD06 | 1.0 |  | 230 € | 1 | 1 | 9    | 0.04 |
| Top Ø 70 | TT10VD07 |     |  | 243 € | 1 | 1 | 11.5 | 0.05 |
| Top Ø 80 | TT10VD08 |     |  | 263 € | 1 | 1 | 14   | 0.07 |
| Top Ø 90 | TT10VD09 |     |  | 302 € | 1 | 1 | 18   | 0.09 |

| Version | Code | Thickness | Finish | Optional | Q.ty | boxes | Kg | M <sup>3</sup> |
|---------|------|-----------|--------|----------|------|-------|----|----------------|
|---------|------|-----------|--------|----------|------|-------|----|----------------|

### Top Square Glass with 1 Bush

|           |          |     |  | GVB   |   |   |    |      |
|-----------|----------|-----|--|-------|---|---|----|------|
| Top 60x60 | TT10VQ06 | 1.0 |  | 270 € | 1 | 1 | 11 | 0.04 |
| Top 70x70 | TT10VQ07 |     |  | 296 € | 1 | 1 | 14 | 0.05 |
| Top 80x80 | TT10VQ08 |     |  | 336 € | 1 | 1 | 18 | 0.07 |
| Top 90x90 | TT10VQ09 |     |  | 366 € | 1 | 1 | 23 | 0.09 |

| Version | Code | Thickness | Finish | Optional | Q.ty | boxes | Kg | M <sup>3</sup> |
|---------|------|-----------|--------|----------|------|-------|----|----------------|
|---------|------|-----------|--------|----------|------|-------|----|----------------|

### Top Round CristalCeramic C/4 Bush

|          |          |           |  | GKA   | GKB   | GMA   |   |   |     |      |
|----------|----------|-----------|--|-------|-------|-------|---|---|-----|------|
| Top Ø 50 | TT14CD05 | 1.1 - 1.4 |  | 162 € | 180 € | 196 € | 1 | 1 | 7.5 | 0.02 |
| Top Ø 60 | TT14CD06 |           |  | 202 € | 224 € | 250 € | 1 | 1 | 9.5 | 0.04 |
| Top Ø 70 | TT14CD07 |           |  | 227 € | 257 € | 283 € | 1 | 1 | 12  | 0.05 |
| Top Ø 80 | TT14CD08 |           |  | 271 € | 289 € | 326 € | 1 | 1 | 15  | 0.07 |
| Top Ø 90 | TT14CD09 | 1.6       |  | 317 € | 349 € | 398 € | 1 | 1 | 19  | 0.09 |

| Version | Code | Thickness | Finish | Optional | Q.ty | boxes | Kg | M <sup>3</sup> |
|---------|------|-----------|--------|----------|------|-------|----|----------------|
|---------|------|-----------|--------|----------|------|-------|----|----------------|

### Top Square CristalCeramic C/4 Bush

|           |          |           |  | GKA   | GKB   | GMA   |   |   |      |      |
|-----------|----------|-----------|--|-------|-------|-------|---|---|------|------|
| Top 50x50 | TT14CQ05 | 1.1 - 1.4 |  | 162 € | 180 € | 196 € | 1 | 1 | 8.5  | 0.02 |
| Top 60x60 | TT14CQ06 |           |  | 202 € | 224 € | 250 € | 1 | 1 | 11.5 | 0.04 |
| Top 70x70 | TT14CQ07 |           |  | 227 € | 257 € | 283 € | 1 | 1 | 15   | 0.05 |
| Top 80x80 | TT14CQ08 |           |  | 271 € | 289 € | 326 € | 1 | 1 | 19   | 0.07 |
| Top 90x90 | TT14CQ09 | 1.6       |  | 317 € | 349 € | 398 € | 1 | 1 | 23.5 | 0.09 |

## Top finishes

### Glossy Glass

|            |  |
|------------|--|
| <b>GVB</b> | EXTRA CLEAR TRANSPARENT <b>J01</b> , EXTRA CLEAR GLOSSY WHITE <b>J21</b> , EXTRA CLEAR GLOSSY CHERRY RED <b>J25</b> , EXTRA CLEAR GLOSSY BLUE SAPPHIRE <b>J26</b> , EXTRA CLEAR GLOSSY BLUE TURQUOISE <b>J27</b> |
|------------|--|

## Top finishes

### Crystal Ceramic and Ceramic

|            |  |
|------------|--|
| <b>GKA</b> | CHARCOAL SAVOIA <b>K11</b> , CEMENT SAVOIA <b>K12</b>  |
| <b>GKB</b> | WHITE CALCE <b>K24</b> , BLACK CALCE <b>K25</b> , TORTORA CALCE <b>K26</b> , PIASENTINA STONE TAUPE Materica <b>K55</b> , TERRACOTTA Matt <b>K90</b> , MATT GREEN <b>K91</b> |

### Crystal Ceramic and Ceramic

|            |   |
|------------|---|
| <b>GMA</b> | MARBLE CALACATTA GLOSSY WHITE <b>K32</b> , BLACK GREEK MARBLE <b>K33</b> , MARBLE GLOSSY NOIR DESIR <b>K35</b> , MARBLE CALACATTA MATT WHITE <b>K42</b> , MARBLE MATT NOIR DESIR <b>K45</b> , MARBLE MATT GREEN TINOS <b>K46</b> , MARBLE STATUARIO WHITE MATT <b>K47</b> , MARBLE CALACAT BLACK Bush Hammered <b>K50</b> |
|------------|---|

## Marble Top



| Version | Code | Thickness | Finish | Optional | Q.ty | boxes | Kg | M <sup>3</sup> |
|---------|------|-----------|--------|----------|------|-------|----|----------------|
|---------|------|-----------|--------|----------|------|-------|----|----------------|

### Marble Round Top

|          |          |     |  | GMM   |   |   |    |      |
|----------|----------|-----|--|-------|---|---|----|------|
| Top Ø 60 | TT20ND06 | 2.0 |  | 579 € | 1 | 1 | 15 | 0.04 |
| Top Ø 70 | TT20ND07 |     |  | 688 € | 1 | 1 | 20 | 0.05 |
| Top Ø 80 | TT20ND08 |     |  | 798 € | 1 | 1 | 26 | 0.07 |

## Top finishes

### Marble

|            |   |
|------------|---|
| <b>GMM</b> | BEIGE TRAVERTINO ROMANO <b>MB2</b> , WHITE CALACATTA VAGLI <b>MB4</b> , BLACK MARQUINIA <b>MN4</b> , GREEN TINOS <b>MVE</b> |
|------------|---|

## Melamine Top



| Version | Code | Thickness |  | Finish | Optional | Q.ty | boxes | Kg | M <sup>2</sup> |
|---------|------|-----------|--|--------|----------|------|-------|----|----------------|
|---------|------|-----------|--|--------|----------|------|-------|----|----------------|

### Melamine Round Top

|           |          |     |  | HLI   |  |   |   |      |      |
|-----------|----------|-----|--|-------|--|---|---|------|------|
| Top Ø 50  | TT18MD05 | 1.8 |  | 61 €  |  | 1 | 1 | 5    | 0.02 |
| Top Ø 60  | TT18MD06 |     |  | 66 €  |  | 1 | 1 | 6    | 0.04 |
| Top Ø 70  | TT18MD07 |     |  | 88 €  |  | 1 | 1 | 7.5  | 0.05 |
| Top Ø 80  | TT18MD08 |     |  | 112 € |  | 1 | 1 | 9    | 0.07 |
| Top Ø 90  | TT36MD09 | 3.6 |  | 132 € |  | 1 | 1 | 16.5 | 0.09 |
| Top Ø 100 | TT36MD10 |     |  | 167 € |  | 1 | 1 | 20   | 0.11 |
| Top Ø 120 | TT36MD12 |     |  | 215 € |  | 1 | 1 | 28.5 | 0.15 |

| Version | Code | Thickness |  | Finish | Optional | Q.ty | boxes | Kg | M <sup>2</sup> |
|---------|------|-----------|--|--------|----------|------|-------|----|----------------|
|---------|------|-----------|--|--------|----------|------|-------|----|----------------|

### Melamine Round Top

|           |          |     |  | HLI   |  |   |   |      |      |
|-----------|----------|-----|--|-------|--|---|---|------|------|
| Top 50x50 | TT18MQ05 | 1.8 |  | 59 €  |  | 1 | 1 | 5    | 0.02 |
| Top 60x60 | TT18MQ06 |     |  | 71 €  |  | 1 | 1 | 7    | 0.04 |
| Top 70x70 | TT18MQ07 |     |  | 92 €  |  | 1 | 1 | 9    | 0.05 |
| Top 80x80 | TT18MQ08 |     |  | 118 € |  | 1 | 1 | 11.5 | 0.07 |
| Top 90x90 | TT36MQ09 | 3.6 |  | 140 € |  | 1 | 1 | 21   | 0.09 |

| Version | Code | Thickness |  | Finish | Optional | Q.ty | boxes | Kg | M <sup>2</sup> |
|---------|------|-----------|--|--------|----------|------|-------|----|----------------|
|---------|------|-----------|--|--------|----------|------|-------|----|----------------|

### Melamine oval Top

|                 |          |     |  | HLI   |  |   |   |   |      |
|-----------------|----------|-----|--|-------|--|---|---|---|------|
| Top 120x50 Oval | TT18MG12 | 1.8 |  | 118 € |  | 1 | 1 | 9 | 0.02 |

### Top finishes

#### Melamine

|            |  |
|------------|--|
| <b>HLI</b> | WHITE <b>M01</b> , GRAFITE <b>M02</b> , BLACK <b>M04</b> , SAND <b>M07</b> |
|------------|--|

## Top MDF



| Version | Code | Thickness |  | Finish | Optional | Q.ty | boxes | Kg | M <sup>3</sup> |
|---------|------|-----------|--|--------|----------|------|-------|----|----------------|
|---------|------|-----------|--|--------|----------|------|-------|----|----------------|

### MDF Round Top

|          |          |     |  | LM1   |  |   |   |     |      |
|----------|----------|-----|--|-------|--|---|---|-----|------|
| Top Ø 50 | TT19LD05 |     |  | 89 €  |  | 1 | 1 | 4   | 0.02 |
| Top Ø 60 | TT19LD06 |     |  | 114 € |  | 1 | 1 | 5   | 0.04 |
| Top Ø 70 | TT19LD07 | 1.9 |  | 146 € |  | 1 | 1 | 6.5 | 0.05 |
| Top Ø 80 | TT19LD08 |     |  | 183 € |  | 1 | 1 | 8   | 0.07 |
| Top Ø 90 | TT19LD09 |     |  | 224 € |  | 1 | 1 | 9.5 | 0.09 |

| Version | Code | Thickness |  | Finish | Optional | Q.ty | boxes | Kg | M <sup>3</sup> |
|---------|------|-----------|--|--------|----------|------|-------|----|----------------|
|---------|------|-----------|--|--------|----------|------|-------|----|----------------|

### MDF Square Top

|           |          |     |  | LM1   |  |   |   |     |      |
|-----------|----------|-----|--|-------|--|---|---|-----|------|
| Top 50x50 | TT19LQ05 |     |  | 96 €  |  | 1 | 1 | 5   | 0.02 |
| Top 60x60 | TT19LQ06 |     |  | 119 € |  | 1 | 1 | 6.5 | 0.04 |
| Top 70x70 | TT19LQ07 | 1.9 |  | 153 € |  | 1 | 1 | 8   | 0.05 |
| Top 80x80 | TT19LQ08 |     |  | 188 € |  | 1 | 1 | 10  | 0.07 |
| Top 90x90 | TT19LQ09 |     |  | 232 € |  | 1 | 1 | 12  | 0.09 |

### Top finishes

#### Lacquered MDF

|            |   |
|------------|---|
| <b>LMI</b> | GRAPHITE GREY <b>G02</b> , BLACK <b>G04</b> , WHITE <b>G05</b> , SAND <b>G07</b> , BROWN <b>G41</b> |
|------------|---|

## Top HPL



| Version | Code | Thickness | Finish | Optional | Q.ty | boxes | Kg | M <sup>3</sup> |
|---------|------|-----------|--------|----------|------|-------|----|----------------|
|---------|------|-----------|--------|----------|------|-------|----|----------------|

### HPL Round Top

|            |          |     | HH1   | HH2   | HH3   |  |   |   |     |      |
|------------|----------|-----|-------|-------|-------|--|---|---|-----|------|
| Top Ø 50   | TT10HD05 |     | 132 € | 138 € | 169 € |  | 1 | 1 | 5   | 0.02 |
| Top Ø 60   | TT10HD06 |     | 185 € | 193 € | 230 € |  | 1 | 1 | 5   | 0.04 |
| Top Ø 70   | TT10HD07 | 1.0 | 200 € | 212 € | 243 € |  | 1 | 1 | 6.5 | 0.05 |
| Top Ø 79,2 | TT10HD08 |     | 233 € | 243 € | 260 € |  | 1 | 1 | 9.5 | 0.07 |
| Top Ø 90   | TT10HD09 |     | 259 € | 268 € | 296 € |  | 1 | 1 | 14  | 0.09 |

| Version | Code | Thickness | Finish | Optional | Q.ty | boxes | Kg | M <sup>3</sup> |
|---------|------|-----------|--------|----------|------|-------|----|----------------|
|---------|------|-----------|--------|----------|------|-------|----|----------------|

### HPL Square Top Radius 10

|                         |          |     | HH1   | HH2   | HH3   |  |   |   |      |      |
|-------------------------|----------|-----|-------|-------|-------|--|---|---|------|------|
| Top 50x50 Radius 10     | TT10HQ05 |     | 138 € | 144 € | 175 € |  | 1 | 1 | 6    | 0.02 |
| Top 60x60 Radius 10     | TT10HQ06 |     | 191 € | 199 € | 236 € |  | 1 | 1 | 6.5  | 0.04 |
| Top 70x70 Radius 10     | TT10HQ07 | 1.0 | 206 € | 218 € | 249 € |  | 1 | 1 | 8    | 0.05 |
| Top 79,2x79,2 Radius 10 | TT10HQ08 |     | 239 € | 249 € | 266 € |  | 1 | 1 | 10.5 | 0.07 |
| Top 90x90 Radius 10     | TT10HQ09 |     | 265 € | 274 € | 302 € |  | 1 | 1 | 13   | 0.09 |

| Version | Code | Thickness | Finish | Optional | Q.ty | boxes | Kg | M <sup>3</sup> |
|---------|------|-----------|--------|----------|------|-------|----|----------------|
|---------|------|-----------|--------|----------|------|-------|----|----------------|

### HPL Square Top Radius 60

|                     |          |     | HH1   | HH2   | HH3   |  |   |   |      |      |
|---------------------|----------|-----|-------|-------|-------|--|---|---|------|------|
| Top 75x75 Radius 60 | TT10HQ75 | 1.0 | 265 € | 278 € | 295 € |  | 1 | 1 | 10.5 | 0.07 |
| Top 85x85 Radius 60 | TT10HQ85 |     | 309 € | 322 € | 342 € |  | 1 | 1 | 13   | 0.09 |

| Version | Code | Thickness | Finish | Optional | Q.ty | boxes | Kg | M <sup>3</sup> |
|---------|------|-----------|--------|----------|------|-------|----|----------------|
|---------|------|-----------|--------|----------|------|-------|----|----------------|

### HPL oval Top

|                 |          |     | HH1   | HH2   | HH3   |  |   |   |   |      |
|-----------------|----------|-----|-------|-------|-------|--|---|---|---|------|
| Top 120x50 Oval | TT10HG12 | 1.0 | 248 € | 262 € | 283 € |  | 1 | 1 | 9 | 0.02 |

### Top finishes

#### HPL

|            |  |            |   |
|------------|--|------------|---|
| <b>HH1</b> | WHITE/Black Core <b>HB4</b> , BLACK/Black Core <b>HN4</b>  | <b>HH2</b> | CEMENT/Black Core <b>HC6</b> , CORTEN/Brown Core <b>HC7</b> , DARK GREY/Black Core <b>HGW</b> |
| <b>HH3</b> | ST WHITE/White Core <b>AB4</b> , ST SAND/Sand Core <b>ACR</b> , ST GRAPHITE GREY/ Grafite Core <b>AGD</b> , ST BLACK/Black Core <b>AN4</b> , ST TORTORA/Tortora Core <b>ATR</b> , ST RED NAMIB/Red Core <b>FAM</b> , ST YELLOW EVORA/Yellow Core <b>FGO</b> , ST RED BULGARO/Red Core <b>FRB</b> , ST GREEN KITAMI/Green Core <b>FVK</b> |            |   |

## Top sheet metal

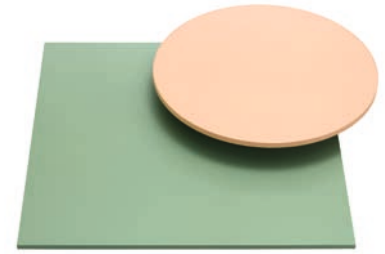

| Version | Code | Thickness |  | Finish | Optional | Q.ty | boxes | Kg | M³ |
|---------|------|-----------|--|--------|----------|------|-------|----|----|
|---------|------|-----------|--|--------|----------|------|-------|----|----|

### Sheet metal round Top

|          |          |     |       | M1    | M2    | O1    | O2    |   |   |      |      |      |
|----------|----------|-----|-------|-------|-------|-------|-------|---|---|------|------|------|
| Top Ø 50 | TT03ID05 | 0.3 |       | 88 €  | 114 € | 116 € | 136 € |   | 1 | 1    | 6    | 0.02 |
| Top Ø 60 | TT03ID06 |     | 101 € | 126 € | 127 € | 152 € |       | 1 | 1 | 8    | 0.04 |      |
| Top Ø 70 | TT03ID07 |     | 112 € | 140 € | 140 € | 170 € |       | 1 | 1 | 10.5 | 0.05 |      |
| Top Ø 80 | TT03ID08 |     | 128 € | 155 € | 152 € | 179 € |       | 1 | 1 | 13.5 | 0.07 |      |
| Top Ø 90 | TT03ID09 |     | 148 € | 175 € | 172 € | 199 € |       | 1 | 1 | 16.5 | 0.09 |      |

| Version | Code | Thickness |  | Finish | Optional | Q.ty | boxes | Kg | M³ |
|---------|------|-----------|--|--------|----------|------|-------|----|----|
|---------|------|-----------|--|--------|----------|------|-------|----|----|

### Sheet metal square Top

|                     |          |     |       | M1    | M2    | O1    | O2    |   |   |      |      |      |
|---------------------|----------|-----|-------|-------|-------|-------|-------|---|---|------|------|------|
| Top 50x50 Radius 60 | TT03IQ50 | 0.3 |       | 93 €  | 119 € | 124 € | 150 € |   | 1 | 1    | 7.5  | 0.02 |
| Top 60x60 Radius 60 | TT03IQ60 |     | 105 € | 130 € | 140 € | 167 € |       | 1 | 1 | 10   | 0.04 |      |
| Top 70x70 Radius 60 | TT03IQ70 |     | 111 € | 137 € | 152 € | 178 € |       | 1 | 1 | 13   | 0.05 |      |
| Top 75x75 Radius 60 | TT03IQ75 |     | 116 € | 140 € | 152 € | 178 € |       | 1 | 1 | 15   | 0.05 |      |
| Top 80x80 Radius 60 | TT03IQ80 |     | 126 € | 152 € | 155 € | 181 € |       | 1 | 1 | 16.5 | 0.07 |      |
| Top 85x85 Radius 60 | TT03IQ85 |     | 130 € | 155 € | 158 € | 184 € |       | 1 | 1 | 18.5 | 0.07 |      |
| Top 90x90 Radius 60 | TT03IQ90 |     | 135 € | 161 € | 166 € | 192 € |       | 1 | 1 | 20.5 | 0.09 |      |

### Note:

--

### Top finishes

#### Metal

|           |   |
|-----------|---|
| <b>M1</b> | WHITE <b>BB</b> , INDUSTRIAL <b>E5</b> , BROWN <b>E6</b> , SAND <b>EC</b> , WHITE PEARL <b>EF</b> , GRAPHITE <b>EG</b> , BLACK <b>EN</b>  |
| <b>M2</b> | LIGHT BLUE <b>E0</b> , OCEAN BLUE <b>E1</b> , FANGO <b>E3</b> , PASTEL YELLOW <b>E4</b> , OCHER YELLOW <b>E7</b> , FACEPOWDER PINK <b>E8</b> , SAGE GREEN <b>E9</b> , PAPAYA ORANGE <b>EA</b> , BLUE SAPPHIRE <b>EE</b> , BLUE TURQUOISE <b>EH</b> , PINE GREEN <b>EJ</b> , DARK GREEN <b>EL</b> , GOLDEN YELLOW <b>EO</b> , CHERRY RED <b>EQ</b> , RED <b>ER</b> , ASH GREY <b>ES</b> , LIGHT GREY <b>ET</b> , BRONZE <b>EZ</b> + TRANSP., BULGARO RED <b>FP</b> |

#### Metal Outdoor

|           |   |
|-----------|---|
| <b>O1</b> | Outdoor BROWN <b>E6</b> , Outdoor WHITE <b>BB</b> , Outdoor SAND <b>EC</b> , Outdoor WHITE PEARL <b>EF</b> , Outdoor GRAFITE <b>EG</b> , Outdoor BLACK <b>EN</b>  |
| <b>O2</b> | Outdoor LIGHT BLUE <b>E0</b> , Outdoor OCEAN BLUE <b>E1</b> , Outdoor FANGO <b>E3</b> , Outdoor PASTEL YELLOW <b>E4</b> , Outdoor OCHER YELLOW <b>E7</b> , Outdoor FACEPOWDER PINK <b>E8</b> , Outdoor SAGE GREEN <b>E9</b> , Outdoor BLUE SAPPHIRE <b>EE</b> , Outdoor BLUE TURQUOISE <b>EH</b> , Outdoor PINE GREEN <b>EJ</b> , Outdoor DARK GREEN <b>EL</b> , Outdoor GOLD YELLOW <b>EO</b> , Outdoor RED BULGARO <b>FP</b> , Outdoor CHERRY RED <b>EQ</b> , Outdoor RED <b>ER</b> , Outdoor ASH GREY <b>ES</b> , Outdoor LIGHT GREY <b>ET</b> , Outdoor PAPAYA ORANGE <b>EA</b> , Outdoor BRONZE <b>EZ</b> +TRANSP. |

## Top Metal

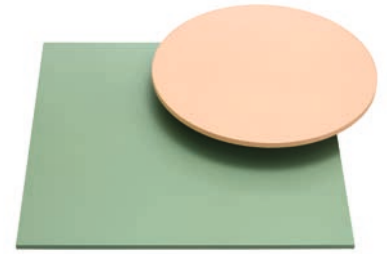

| Version | Code | Thickness | Finish |  |  |  | Optional | Q.ty | boxes | Kg | M <sup>2</sup> |
|---------|------|-----------|--------|--|--|--|----------|------|-------|----|----------------|
|---------|------|-----------|--------|--|--|--|----------|------|-------|----|----------------|

### Metal Round Top

|          |          |     | M1    | M2    | O1    | O2    |  |   |   |      |      |
|----------|----------|-----|-------|-------|-------|-------|--|---|---|------|------|
| Top Ø 60 | TT15LD06 | 1.5 | 132 € | 159 € | 159 € | 187 € |  | 1 | 1 | 9    | 0.04 |
| Top Ø 70 | TT15LD07 |     | 158 € | 188 € | 186 € | 214 € |  | 1 | 1 | 11.5 | 0.05 |
| Top Ø 80 | TT15LD08 |     | 223 € | 252 € | 252 € | 278 € |  | 1 | 1 | 14.5 | 0.07 |

| Version | Code | Thickness | Finish |  |  |  | Optional | Q.ty | boxes | Kg | M <sup>2</sup> |
|---------|------|-----------|--------|--|--|--|----------|------|-------|----|----------------|
|---------|------|-----------|--------|--|--|--|----------|------|-------|----|----------------|

### Square Metal Top

|           |          |     | M1    | M2    | O1    | O2    |  |   |   |    |      |
|-----------|----------|-----|-------|-------|-------|-------|--|---|---|----|------|
| Top 50x50 | TT15LQ50 | 1.5 | 152 € | 178 € | 176 € | 202 € |  | 1 | 1 | 8  | 0.02 |
| Top 60x60 | TT15LQ60 |     | 160 € | 188 € | 188 € | 214 € |  | 1 | 1 | 11 | 0.04 |
| Top 70x70 | TT15LQ70 |     | 175 € | 201 € | 201 € | 228 € |  | 1 | 1 | 14 | 0.05 |
| Top 80x80 | TT15LQ80 |     | 212 € | 238 € | 238 € | 265 € |  | 1 | 1 | 18 | 0.07 |
| Top 90x90 | TT15LQ90 |     | 235 € | 261 € | 261 € | 288 € |  | 1 | 1 | 22 | 0.09 |

#### Note:

NOT AVAILABLE in Industrial E5 finish - Top MDF hydrophobic + metal

### Top finishes

#### Metal

|           |   |
|-----------|---|
| <b>M1</b> | WHITE <b>BB</b> , BROWN <b>E6</b> , SAND <b>EC</b> , WHITE PEARL <b>EF</b> , GRAPHITE <b>EG</b> , BLACK <b>EN</b>   |
| <b>M2</b> | LIGHT BLUE <b>E0</b> , OCEAN BLUE <b>E1</b> , FANGO <b>E3</b> , PASTEL YELLOW <b>E4</b> , OCHER YELLOW <b>E7</b> , FACEPOWDER PINK <b>E8</b> , SAGE GREEN <b>E9</b> , PAPAYA ORANGE <b>EA</b> , BLUE SAPPHIRE <b>EE</b> , BLUE TURQUOISE <b>EH</b> , PINE GREEN <b>EJ</b> , DARK GREEN <b>EL</b> , GOLDEN YELLOW <b>EO</b> , CHERRY RED <b>EQ</b> , RED <b>ER</b> , ASH GREY <b>ES</b> , LIGHT GREY <b>ET</b> , BRONZE <b>EZ</b> + TRANSP., BULGARO RED <b>FP</b> |

#### Metal Outdoor

|           |   |
|-----------|---|
| <b>O1</b> | Outdoor BROWN <b>E6</b> , Outdoor WHITE <b>BB</b> , Outdoor SAND <b>EC</b> , Outdoor WHITE PEARL <b>EF</b> , Outdoor GRAFITE <b>EG</b> , Outdoor BLACK <b>EN</b>  |
| <b>O2</b> | Outdoor LIGHT BLUE <b>E0</b> , Outdoor OCEAN BLUE <b>E1</b> , Outdoor FANGO <b>E3</b> , Outdoor PASTEL YELLOW <b>E4</b> , Outdoor OCHER YELLOW <b>E7</b> , Outdoor FACEPOWDER PINK <b>E8</b> , Outdoor SAGE GREEN <b>E9</b> , Outdoor BLUE SAPPHIRE <b>EE</b> , Outdoor BLUE TURQUOISE <b>EH</b> , Outdoor PINE GREEN <b>EJ</b> , Outdoor DARK GREEN <b>EL</b> , Outdoor GOLD YELLOW <b>EO</b> , Outdoor RED BULGARO <b>FP</b> , Outdoor CHERRY RED <b>EQ</b> , Outdoor RED <b>ER</b> , Outdoor ASH GREY <b>ES</b> , Outdoor LIGHT GREY <b>ET</b> , Outdoor PAPAYA ORANGE <b>EA</b> , Outdoor BRONZE <b>EZ</b> +TRANSP. |

# Accessories

# Accessoires design Officina delle Idee

## Accessoires

| Model  | Code       | -- | -- | Frame PP Black | Optional | Q.ty | boxes | Kg  | M <sup>3</sup> |
|--|------------|----|----|----------------|----------|------|-------|-----|----------------|
|  |            |    |    |                | ZC       |      |       |     |                |
| <b>Kit 20 Linking device CALLA S MT</b><br> | A1920AGU0N |    |    | 52 €           |          | 1    | 1     | 1.5 | 0.01           |

**Note:**

ATTENTION !: Kit 20 Pcs. - AVAILABLE only for Base Type T

**Linking device**

**Calla S MT**

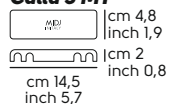

| Model   | Code       | -- | -- | Frame PC Transparent | Optional | Q.ty | boxes | Kg  | M <sup>3</sup> |
|---|------------|----|----|----------------------|----------|------|-------|-----|----------------|
|   |            |    |    |                      | ZC       |      |       |     |                |
| <b>Kit 10 Linking device STACK S</b><br> | A2270AGU0N |    |    | 291 €                |          | 1    | 1     | 2.5 | 0.02           |

**Note:**

ATTENTION ! Kit 10 Pz.

**Linking device**

**Stack S**

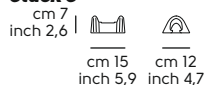

| Model   | Code      | -- | -- | Frame PP Black | Optional | Q.ty | boxes | Kg  | M <sup>3</sup> |
|---|-----------|----|----|----------------|----------|------|-------|-----|----------------|
|   |           |    |    |                | ZC       |      |       |     |                |
| <b>Cart STACK CART</b><br> | A2270CR0N |    |    | 229 €          |          | 1    | 1     | 5.5 | 0.08           |

**Cart STACK CART**

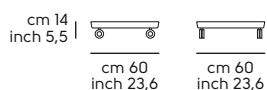

# Finishes

# Similpelle Secret - Secret Faux leather

Cat. TA



**EOB4**  
Bianco - White



**EOV2**  
Vaniglia - Vanilla



**EOB2**  
Beige



**EOS2**  
Sabbia - Sand



**EOTR**  
Tortora



**EORR**  
Rosso - Red



**EORS**  
Rosso Bulgaro - Bulgaro red



**EOM2**  
Marrone - Brown



**EONA**  
Nocciola - Hazel



**EOF2**  
Fango



**EOA8**  
Arancio - Orange



**EOO2**  
Giallo oca - Ocher yellow

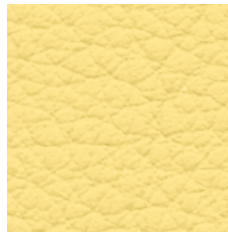

**EOG5**  
Giallo pastello - Pastel yellow

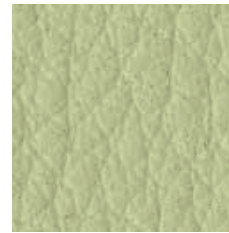

**EOVI**  
Verde pastello - Pastel green



**EOLB**  
Lime



**EOGS**  
Grigio cenere - Ash grey

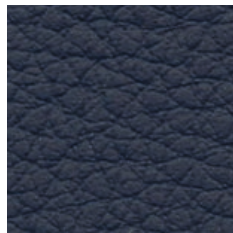

**EOBB**  
Blu - Blue

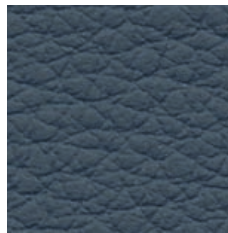

**EOAM**  
Blu avio - Air force blue



**EOVJ**  
Verde pino - Pine green



**EOVE**  
Verde - Green

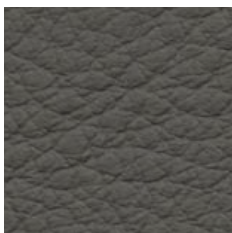

**EOGV**  
Grigio polvere - Dust grey

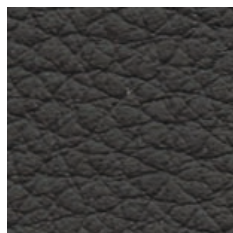

**EOA6**  
Grigio antracite - Anthracite grey

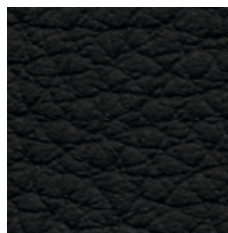

**EON4**  
Nero - Black

# Tessuto Renewed loop - Renewed loop fabric

Cat. TA



**TRT4**  
Testa di moro - Dark brown

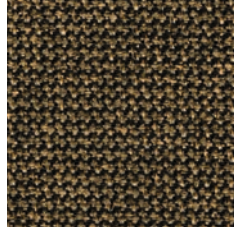

**TRF2**  
Fango

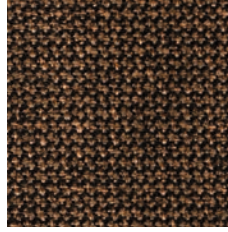

**TRM2**  
Marrone - Brown

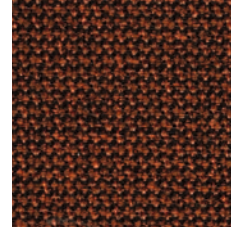

**TRRS**  
Rosso bulgaro - Red bulgaro

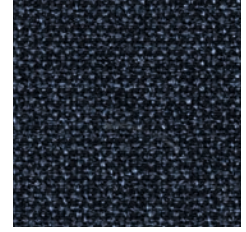

**TRBB**  
Blu - blue

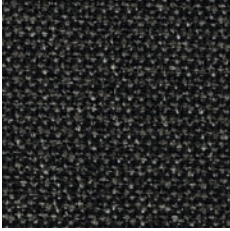

**TRA6**  
Grigio antracite - Anthracite grey



**TRTR**  
Tortora

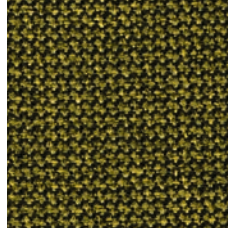

**TRVK**  
Verde salvia - Sage green

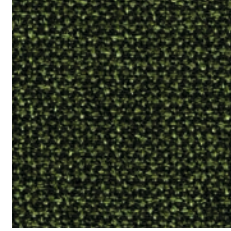

**TRVE**  
Verde - Green

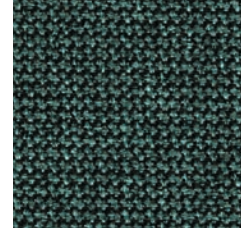

**TRVJ**  
Verde pino - Pine green

# Tessuto Mirage - Mirage fabric

Cat. TA



**TIB2**  
Beige



**TIF2**  
Fango



**TIAK**  
Havana

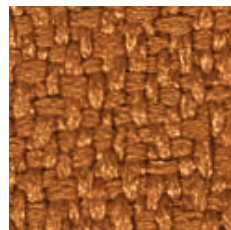

**TINA**  
Nocciola - Hazel

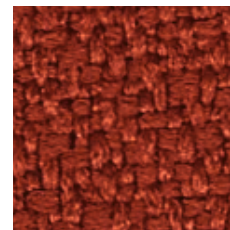

**TIA9**  
Arancio mattone - Brick orange

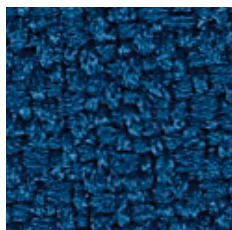

**TIBB**  
Blu - Blue



**TIO4**  
Blu oltremare - Ultramarine blue

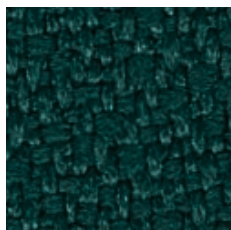

**TIVJ**  
Verde pino - Pine green



**TIG4**  
Giallo - Yellow

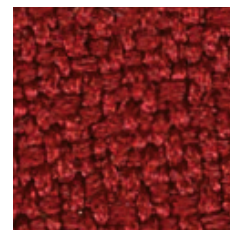

**TIR5**  
Rosso bulgaro - Bulgaro red

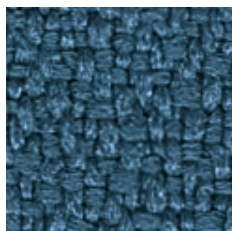

**TIAM**  
Blu avio - Air force blue



**TIGT**  
Grigio chiaro - Light grey



**TIGW**  
Grigio scuro - Dark grey



**TIGV**  
Grigio polvere - Dust grey

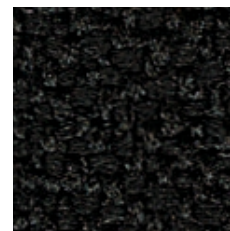

**TIN4**  
Nero - Black



**T7LB**  
Lime



**T7B2**  
Beige



**T7S4**  
Sahara



**T7S2**  
Sabbia - Sand



**T7F2**  
Fango

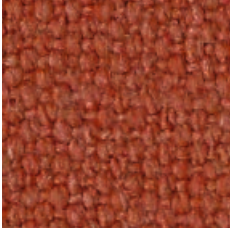

**T7A8**  
Arancio - Orange



**T7RR**  
Rosso - Red

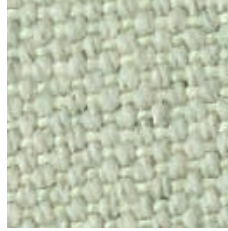

**T7VK**  
Verde salvia - Sage green



**T7VH**  
Verde Oliva - Olive green



**T7VE**  
Verde - Green

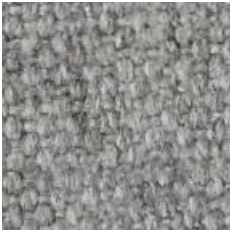

**T7GT**  
Grigio chiaro - Light grey



**T7GD**  
Grigio grafite - Graphite grey

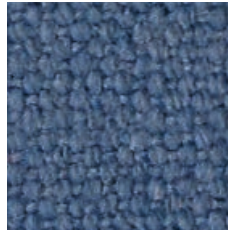

**T7BB**  
Blu - Blue



**T7AZ**  
Azzurro - Light blue

# Similpelle Vintage - Vintage faux leather

Cat. TB



**E2B2**  
Beige



**E2CU**  
Cuoio - Hide



**E2M2**  
Marrone - Brown



**E2F2**  
Fango



**E2T4**  
Testa di moro - Dark brown

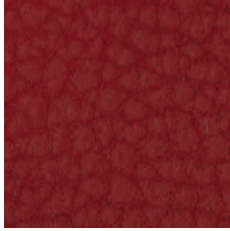

**E2RR**  
Rosso - Red



**E2VE**  
Verde - Green



**E2VL**  
Verde scuro - Dark green

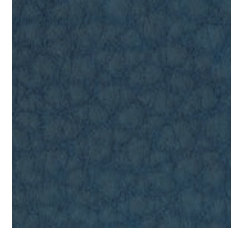

**E2BB**  
Blu - Blue

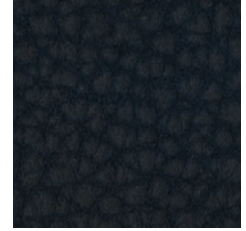

**E2BE**  
Blu scuro - Dark blue

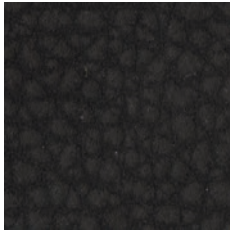

**E2N4**  
Nero - Black

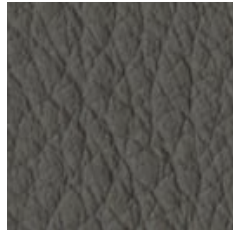

**E2GR**  
Grigio - Grey

# Tessuto Network - Network fabric

Cat. TB

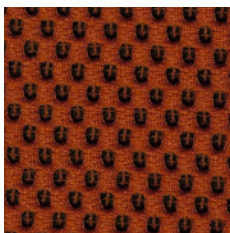

**TNA9**  
Arancio mattone - Brick orange

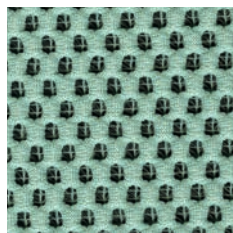

**TNAZ**  
Azzurro - Light blue

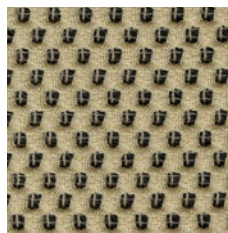

**TNB2**  
Beige

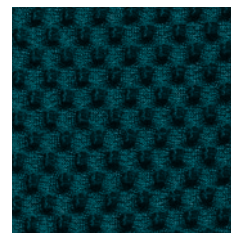

**TNBF**  
Blu ottanio - Teal blue

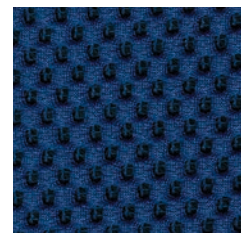

**TNBB**  
Blu - Blue

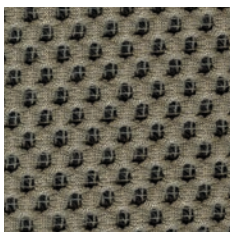

**TNF2**  
Fango - Mud

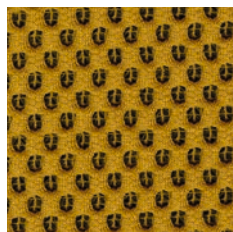

**TNO2**  
Giallo ocre - Ocher yellow

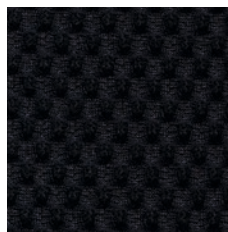

**TNN4**  
Nero - Black

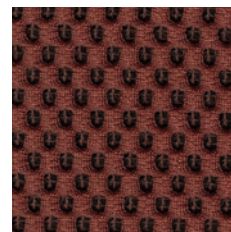

**TNRS**  
Rosso bulgaro - Bulgaro red

# Tessuto Gyre - Gyre fabric

Cat. TB



**TQB2**  
Beige



**TQS2**  
Sabbia - Sand



**TQM2**  
Marrone - Brown



**TQF2**  
Fango



**TQGV**  
Grigio polvere - Dust grey

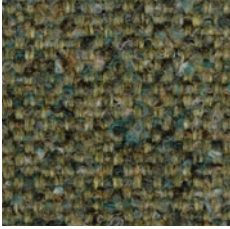

**TQVE**  
Verde - Green



**TQVJ**  
Verde pino - Pine green



**TQRT**  
Rosso scuro - Dark red



**TQAZ**  
Azzurro - Light blue



**TQBB**  
Blu - Blue

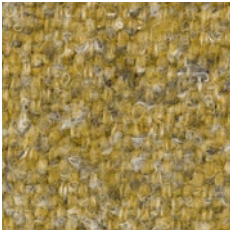

**TQO2**  
Giallo ocre - Ocher  
yellow

# Tessuto Fenix Wool - Fenix Wool fabric

Cat. TB



**T3G4**  
Giallo - Yellow



**T3O2**  
Giallo ocre - Ocher yellow



**T3A8**  
Arancio - Orange

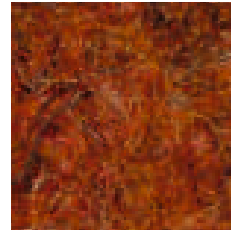

**T3A9**  
Arancio mattone - Brick orange

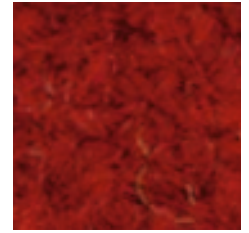

**T3RR**  
Rosso - Red

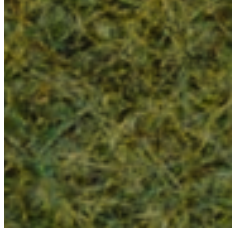

**T3VH**  
Verde oliva - Olive green



**T3VF**  
Verde mela - Apple green



**T3B2**  
Beige



**T3M2**  
Marrone - Brown

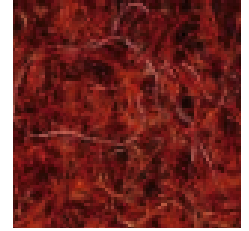

**T3RS**  
Rosso bulgaro - Bulgaro red

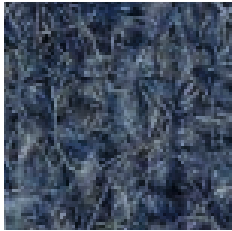

**T3BE**  
Blu scuro - Dark blue

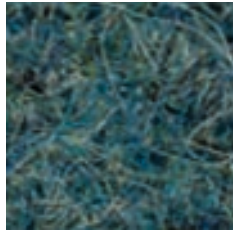

**T3J5**  
Blue jeans

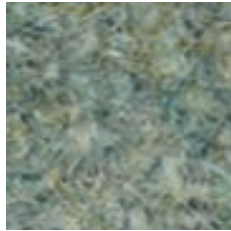

**T3GU**  
Grigio cielo - Sky grey



**T3C6**  
Grigio cemento - Concrete grey



**T3GV**  
Grigio polvere - Dust grey

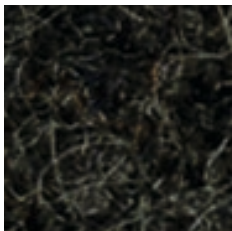

**T3GR**  
Grigio - Grey

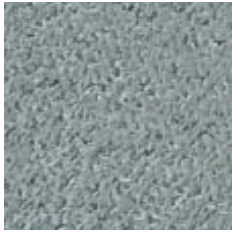

**TGAZ**  
Azzurro - Light blue

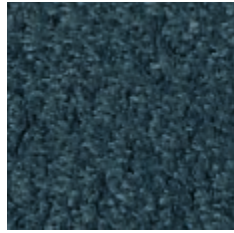

**TGBC**  
Blu oceano - Ocean blue

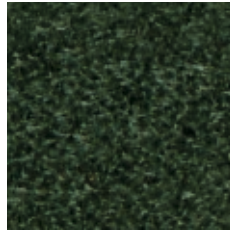

**TGVL**  
Verde scuro - Dark green

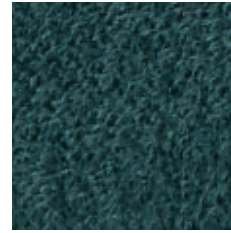

**TGVJ**  
Verde pino - Pine green



**TGG6**  
Giallo oro - Golden yellow

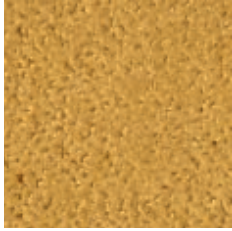

**TGO2**  
Giallo ocre - Ocher yellow

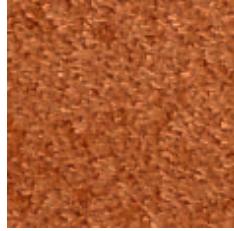

**TGA7**  
Arancio papaya - Papaya orange



**TGRR**  
Rosso - Red



**TGRC**  
Rosso ciliegia - Cherry red

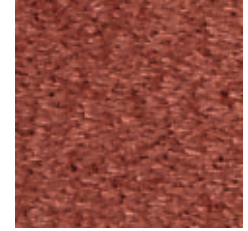

**TGR5**  
Rosso bulgare - Bulgare red

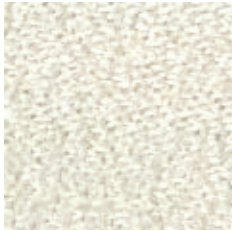

**TGB4**  
Bianco - White

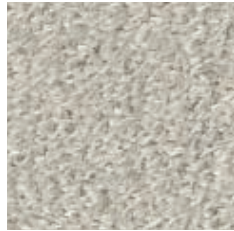

**TGCT**  
Grigio chiaro - Light grey

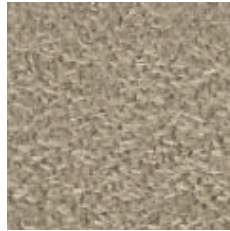

**TGGS**  
Grigio cenere - Ash grey

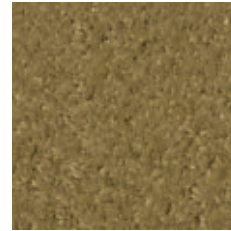

**TGF2**  
Fango

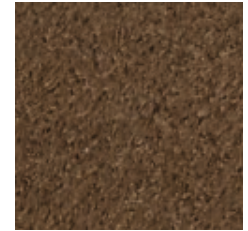

**TGM2**  
Marrone - Brown



**TGGW**  
Grigio scuro - Dark grey



**TGN4**  
Nero - Black

# Tessuto Manhattan - Manhattan fabric

Cat. TB



**TDF2**  
Fango



**TDGW**  
Grigio scuro - Dark grey



**TDGT**  
Grigio chiaro - Light grey



**TDV2**  
Vaniglia - Vanilla



**TDB2**  
Beige



**TDS2**  
Sabbia - Sand



**TDR3**  
Rosa chiaro - Light pink



**TDM2**  
Marrone - Brown



**TDC2**  
Caffè - Coffee

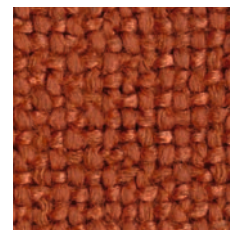

**TDA8**  
Arancio - Orange

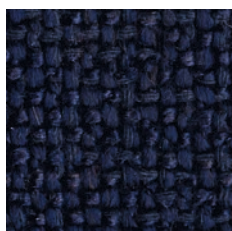

**TDBC**  
Blu oceano - Ocean blue

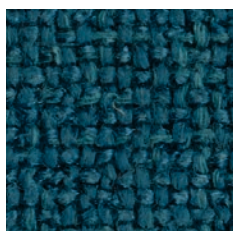

**TDBF**  
Blu ottanio - Teal blue



**TDLB**  
Lime

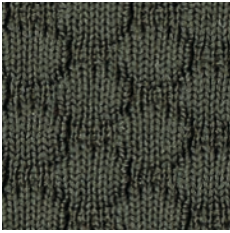

**TCVJ**  
Verde pino - Pine green

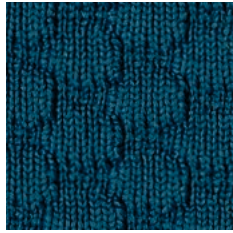

**TCBB**  
Blu - Blue

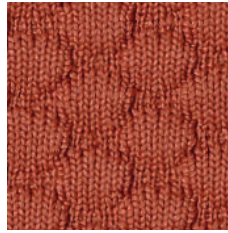

**TCRS**  
Rosso bulgaro - Bulgaro red

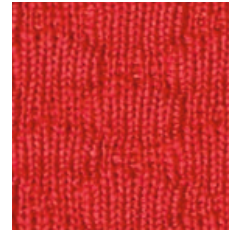

**TCRR**  
Rosso - Red

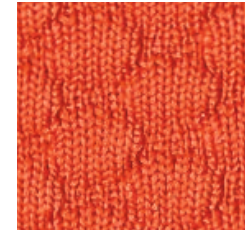

**TCAB**  
Arancio - Orange



**TCM2**  
Marrone - Brown



**TCS2**  
Sabbia - Sand



**TCLB**  
Lime



**TCO2**  
Giallo ocra - Ocher yellow



**TCRI**  
Rosa - Pink



**TCN4**  
Nero - Black



**TCGW**  
Grigio scuro - Dark grey



**TCGT**  
Grigio chiaro - Light grey

# Velluto Superb - Superb velvet

Cat. TC



**T6R3**  
Rosa chiaro - Light pink

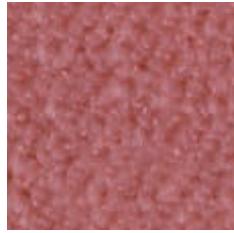

**T6R2**  
Rosa antico - Antique pink



**T6RS**  
Rosso Bulgaro - Bulgaro red

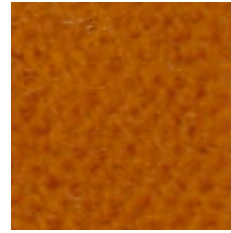

**T6A8**  
Arancio - Orange

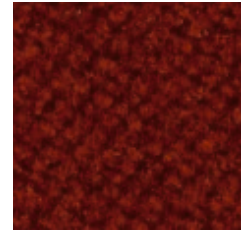

**T6A9**  
Arancio mattone - Brick orange



**T6O2**  
Giallo ocre - Ocher yellow



**T6G4**  
Giallo - Yellow



**T6VH**  
Verde oliva - Olive green



**T6VJ**  
Verde pino - Pine green



**T6A2**  
Acciaio - Steel

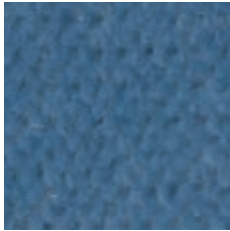

**T6AZ**  
Azzurro - Light blue



**T6BD**  
Blu oltremare - Ultramarine blue



**T6GT**  
Grigio chiaro - Light grey



**T6GR**  
Grigio - Grey



**T6A6**  
Grigio antracite - Anthracite grey



**T6TR**  
Tortora

## Tessuto Plain - Plain fabric

Cat. TC  
 

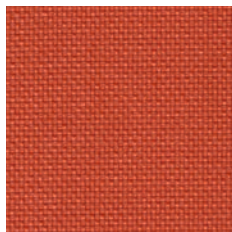

**TPA7**  
Arancio papaya - Papaya orange

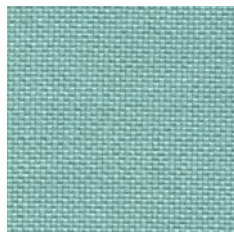

**TPAZ**  
Azzurro - Light blue

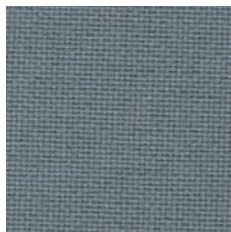

**TAPM**  
Blu avio - Air force blue

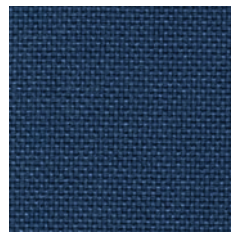

**TPBB**  
Blu - Blue

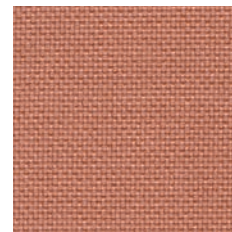

**TPR2**  
Rosa antico - Antique pink



**TPS2**  
Sabbia - Sand

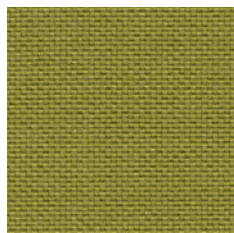

**TPVF**  
Verde mela - Apple green

## Tessuto Flame - Flame fabric

Cat. TC  
 



**TLA7**  
Arancio papaya - Papaya orange

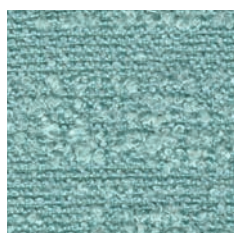

**TLAZ**  
Azzurro - Light blue

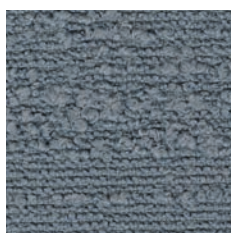

**TLAM**  
Blu avio - Air force blue



**TLBB**  
Blu - Blue



**TLR2**  
Rosa antico - Antique pink



**TLS2**  
Sabbia - Sand

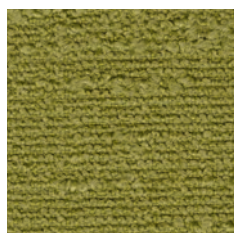

**TLVF**  
Verde mela - Apple green

# Tessuto Ouche - Ouche fabric

Cat. TC

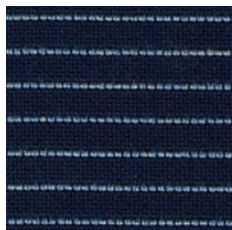

**TOY9**  
Blu avio - Air force blue



**TOY0**  
Grigio avorio - Ivory gray



**TOY2**  
Marrone - Brown

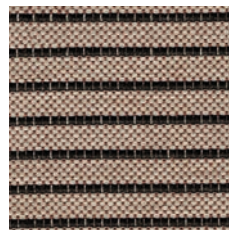

**TOY6**  
Nero - Black

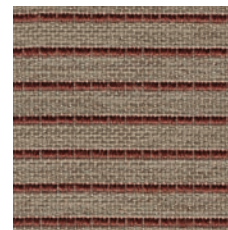

**TOY3**  
Rosso bulgaro - Bulgaro red



**TOY5**  
Verde oliva - Olive green



**TOY8**  
Verde scuro - Dark green

# Tessuto Caltagirone - Caltagirone fabric

Cat. TC



**TTB4**  
Bianco - White



**TTFU**  
Fumo - Smoke



**TTTR**  
Tortora



**TTM2**  
Marrone - Brown



**TTRC**  
Rosso ciliegia - Cherry red



**TTVH**  
Verde oliva - Olive green



**TTVK**  
Verde salvia - Sage green



**TTBB**  
Blu - Blue



**TTGV**  
Grigio polvere - Dust grey



**TTN4**  
Nero - Black



**TTO2**  
Giallo ocre - Ocher yellow

# Tessuto Gemma - Gemma fabric

Cat. TC

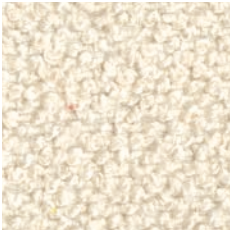

**TSB4**  
Bianco - White



**TSFU**  
Fumo - Smoke

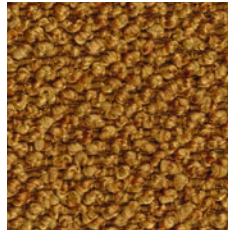

**TSNA**  
Nocciola - Hazelnut



**TSO2**  
Giallo ocre - Ocher yellow

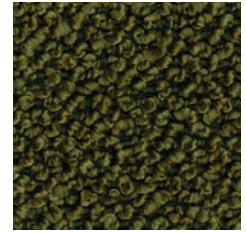

**TSVE**  
Verde - Green



**TSA6**  
Grigio antracite - Anthracite grey



**TSGV**  
Grigio polvere - Dust grey

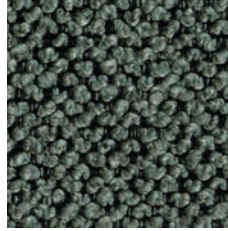

**TSAZ**  
Azzurro - Light blue

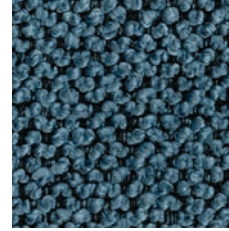

**TSD5**  
Blue denim - Denim blue

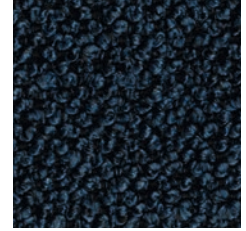

**TSBB**  
Blu - Blue

# Tessuto Jumper - Jumper fabric

Cat. TC

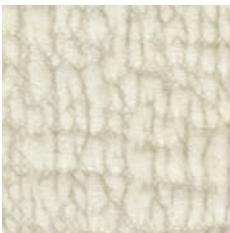

**TJB2**  
Beige



**TJZI**  
Fucsia fluo - Neon pink



**TJZ2**  
Arancio fluo - Neon orange



**TJZ3**  
Giallo fluo - Neon yellow

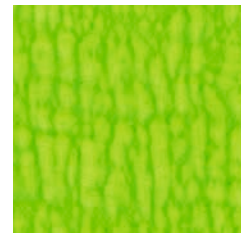

**TJZ4**  
Verde fluo - Neon green

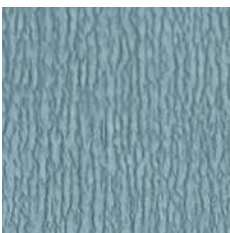

**TJAZ**  
Azzurro - Light blue

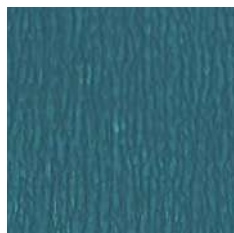

**TJBB**  
Blu - Blue



**TJO2**  
Giallo ocre - Ocher yellow



**TJVT**  
Viola - Purple

# Tessuto Main Line Flax - Main Line Flax fabric

Cat. TC



**TAAZ**  
Azzurro - Light blue



**TAAM**  
Blu avio - Air force blue

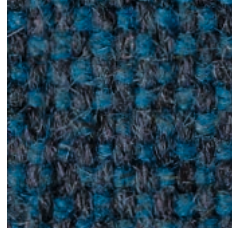

**TABC**  
Blu oceano - Ocean blue



**TAVJ**  
Verde pino - Pine green

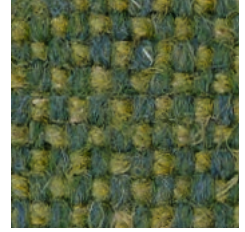

**TAVE**  
Verde - Green



**TAVH**  
Verde oliva - Olive green



**TALB**  
Lime



**TAA8**  
Arancio - Orange



**TARS**  
Rosso Bulgaro - Bulgaro red

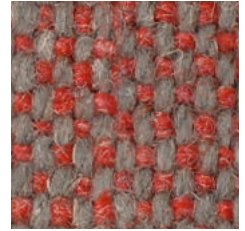

**TAA9**  
Arancio mattone - Brick orange



**TAS4**  
Sahara



**TAM2**  
Marrone - Brown



**TAS2**  
Sabbia - Sand



**TAGT**  
Grigio chiaro - Light grey



**TAGW**  
Grigio scuro - Dark grey



**TAN4**  
Nero - Black

# Tessuto Second - Second fabric

Cat. TC



**T9RS**  
Rosso bulgaro - Bulgaro red

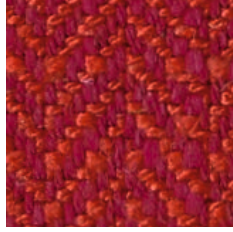

**T9RR**  
Rosso - Red

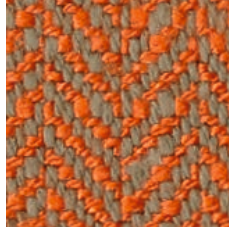

**T9A8**  
Arancio - Orange



**T9BC**  
Blu oceano - Ocean blue

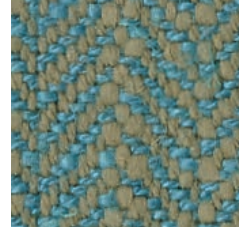

**T9AZ**  
Azzurro - Light blue



**T9M2**  
Marrone - Brown



**T9F2**  
Fango



**T9S2**  
Sabbia - Sand



**T9N4**  
Nero - Black



**T9GD**  
Grigio grafite - Graphite grey



**T9GT**  
Grigio chiaro - Light grey

# Tessuto Oceanic - Oceanic fabric

Cat. TC

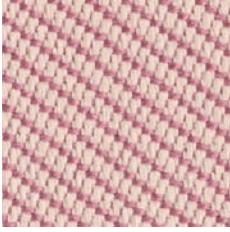

**TER3**  
Rosa chiaro - Light pink

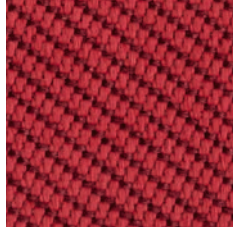

**TERR**  
Rosso - Red

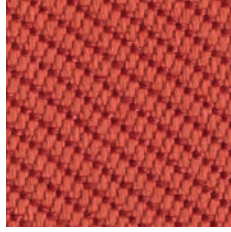

**TEA8**  
Arancio - Orange

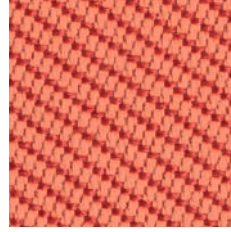

**TEA7**  
Arancio papaya - Papaya orange

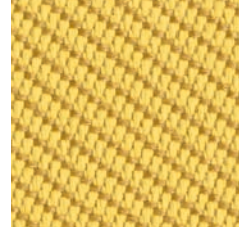

**TEG4**  
Giallo - Yellow

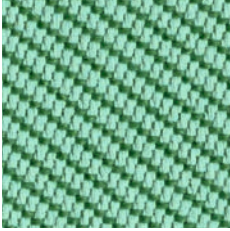

**TEVK**  
Verde salvia - Sage green

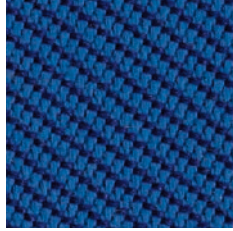

**TEBC**  
Blu oceano - Ocean blue

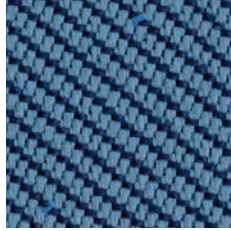

**TED5**  
Blu denim - Denim blue



**TEAZ**  
Azzurro - Light blue

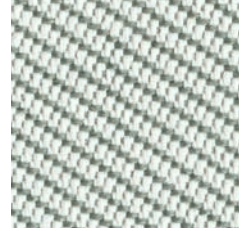

**TEGT**  
Grigio chiaro - Light grey



**TEGR**  
Grigio - Grey

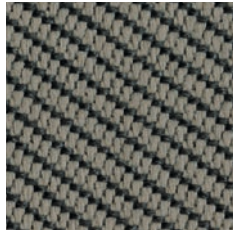

**TETR**  
Tortora

# Tessuto Remix 3 - Remix 3 fabric

Cat. TD

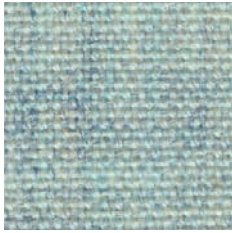

**THAZ**  
Azzurro - Light blue

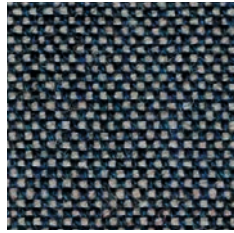

**THJ5**  
Blue jeans

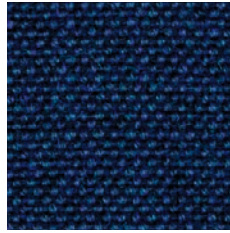

**THBB**  
Blu - Blue

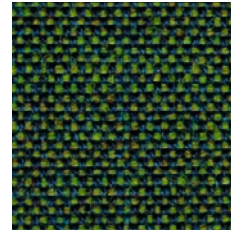

**THVL**  
Verde scuro - Dark green

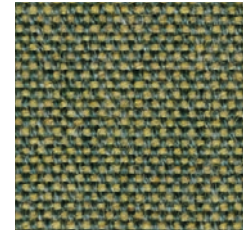

**THVK**  
Verde salvia - Sage green

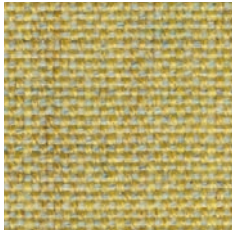

**THG5**  
Giallo pastello - Pastel yellow

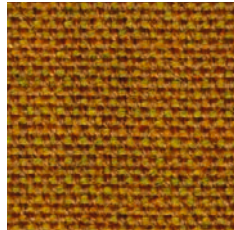

**THO2**  
Giallo ocre - Ocher yellow



**THA8**  
Arancio - Orange

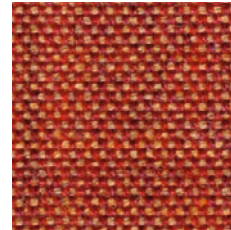

**THA7**  
Arancio papaya - Papaya orange

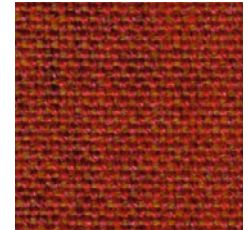

**THRR**  
Rosso - Red



**THB2**  
Beige

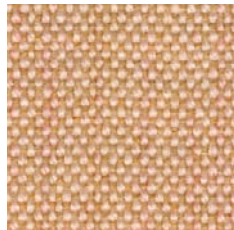

**THR4**  
Rosa cipria - Facepowder pink

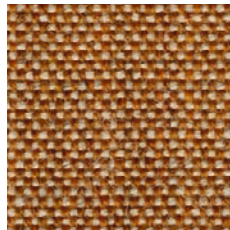

**THNA**  
Nocciola - Hazel



**THT2**  
Terracotta



**THM2**  
Marrone - Brown



**THS2**  
Sabbia - Sand



**THF2**  
Fango



**THGW**  
Grigio scuro - Dark grey

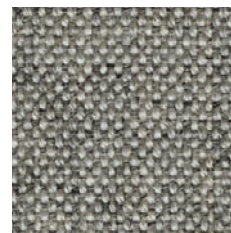

**THGS**  
Grigio cenere - Ash grey

# Tessuto Yoredale - Yoredale fabric

Cat. TD

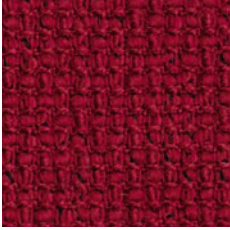

**TFRC**  
Rosso ciliegia - Cherry red



**TFRS**  
Rosso Bulgaro - Bulgargio red



**TFA8**  
Arancio - Orange

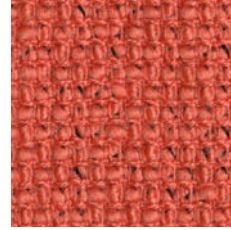

**TFA7**  
Arancio papaya - Papaya orange



**TFO2**  
Giallo ocre - Ocher yellow



**TFBF**  
Blu ottanio - Teal blue

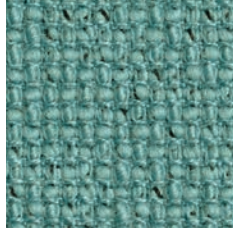

**TFAZ**  
Azzurro - Light blue



**TFR3**  
Rosa chiaro - Light pink



**TFNA**  
Nocciola - Hazel



**TFG5**  
Giallo pastello - Pastel yellow



**TFBB**  
Blu - Blue

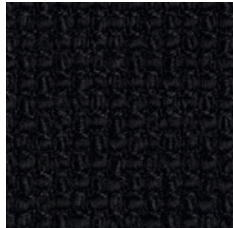

**TFN4**  
Nero - Black



**TFGW**  
Grigio scuro - Dark grey

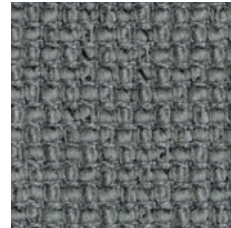

**TFGR**  
Grigio - Grey

# Tessuto Uniform Melange - Uniform Melange fabric

Cat. TE



**TIBE**  
Blu scuro - Dark blue

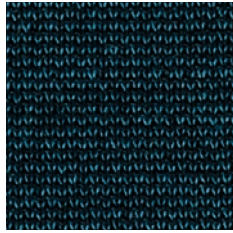

**TIBC**  
Blu oceano - Ocean blue

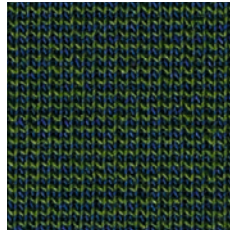

**TIVL**  
Verde scuro - Dark green

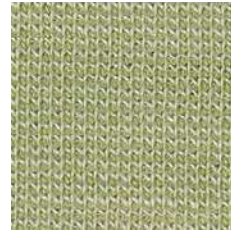

**TIVI**  
Verde pastello - Pastel green

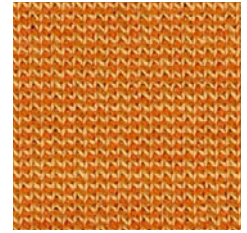

**TIO2**  
Giallo ocre - Ocher yellow

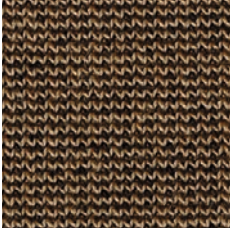

**TIF2**  
Fango

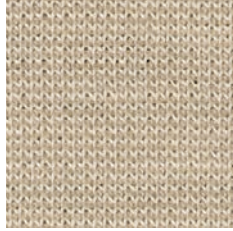

**TIB2**  
Beige

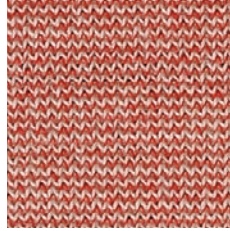

**TIRR**  
Rosso - Red



**TIRC**  
Rosso ciliegia - Cherry red



**TIRS**  
Rosso bulgaro - Bulgaro red

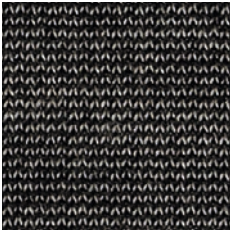

**TIGD**  
Grigio grafite - Graphite grey

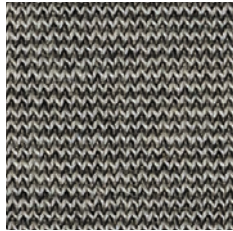

**TIGR**  
Grigio - Grey



**POB4**  
Bianco - White



**POV2**  
Vaniglia - Vanilla



**POS4**  
Sahara



**PONA**  
Nocciola - Hazel



**POCU**  
Cuio - Hide

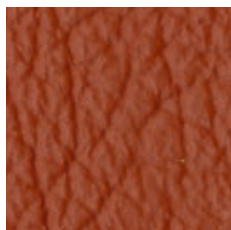

**POT2**  
Terracotta

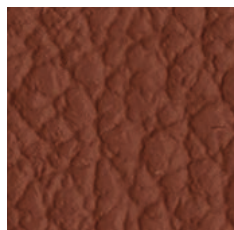

**POBR**  
Marrone - Brown

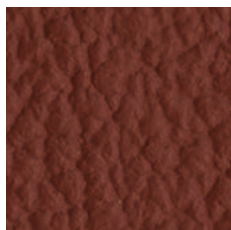

**POBK**  
Rosso bordeaux -  
Bordeaux red

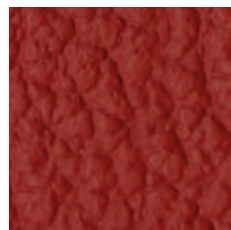

**PORT**  
Rosso scuro - Dark red

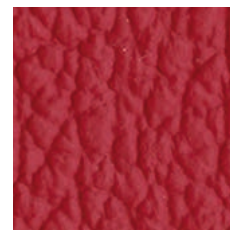

**PORR**  
Rosso - Red



**POA8**  
Arancio - Orange

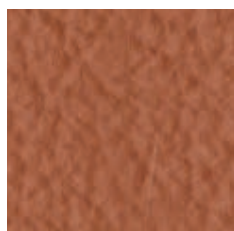

**POA9**  
Arancio mattone - Brick  
orange



**POF2**  
Fango



**POFU**  
Fumo - Smoke



**POT4**  
Testa di moro - Dark brown

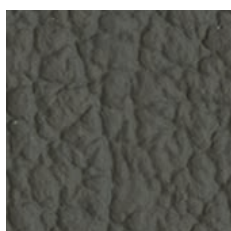

**POGV**  
Grigio polvere - Dust grey



**POGS**  
Grigio cenere - Ash grey



**POSK**  
Azzurro sky - Light blue  
sky



**POD5**  
Blu denim - Denim blue

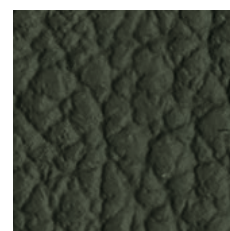

**POVE**  
Verde - Green



**PON4**  
Nero - Black

# Pelle Vintage - Vintage leather

Cat. SV



**P2S2**  
Sabbia - Sand



**P2NA**  
Nocciola - Hazel



**P2M2**  
Marrone - Brown



**P2CU**  
Cuio - Hide



**P2GS**  
Grigio cenere - Ash grey



**P2GR**  
Grigio - Grey



**P2VH**  
Verde oliva - Olive green

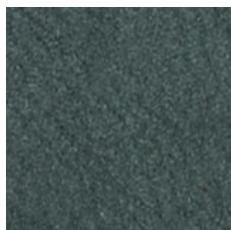

**P2D5**  
Blu denim - Denim blue



**C0BC**  
Blu oceano - Ocean blue



**C0AZ**  
Azzurro - Light blue



**C0VK**  
Verde salvia - Sage green



**C0VJ**  
Verde pino - Pine green



**C0GW**  
Grigio scuro - Dark grey



**C0T4**  
Testa di moro - Dark brown

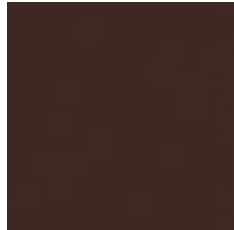

**C0C2**  
Caffè - Coffee

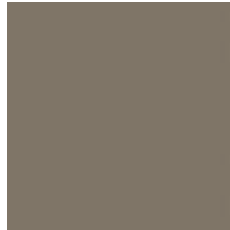

**C0F2**  
Fango



**C0GS**  
Grigio cenere - Ash grey

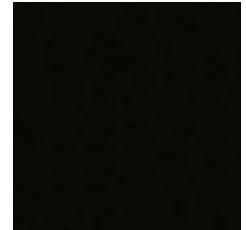

**C0N4**  
Nero - Black

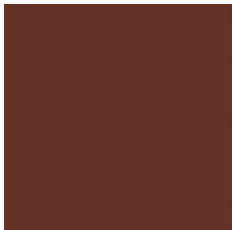

**C0RS**  
Rosso Bulgaro - Bulgaro red



**C0RC**  
Rosso ciliegia - Cherry red



**C0A7**  
Arancio papaya - Papaya orange



**C0O2**  
Giallo ocra - Ocher yellow



**C0S4**  
Sahara



**C0R4**  
Rosa cipria - Facepowder pink



**C0V2**  
Vaniglia - Vanilla

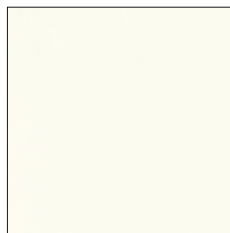

**C0B4**  
Bianco - White

# Cuoio TK - TK hide

Cat. CK



**C2BC**  
Blu oceano - Ocean blue



**C2AZ**  
Azzurro - Light blue



**C2VK**  
Verde salvia - Sage green



**C2VJ**  
Verde pino - Pine green

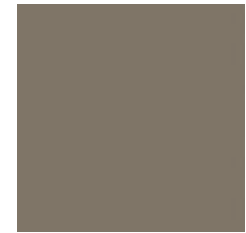

**C2F2**  
Fango

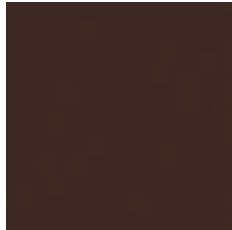

**C2C2**  
Caffè - Coffee

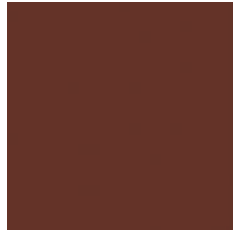

**C2RS**  
Rosso Bulgaro - Bulgaro red



**C2RC**  
Rosso ciliegia - Cherry red



**C2O2**  
Giallo ocre - Ocher yellow

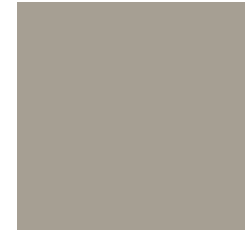

**C2G5**  
Grigio cenere - Ash grey



**C2R4**  
Rosa cipria - Facepowder pink

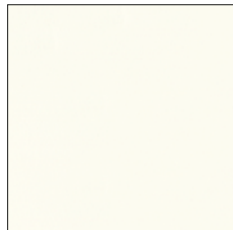

**C2B4**  
Bianco - White



**C2N4**  
Nero - Black

Collezioni Guapa, P47 e Sunrise disponibili solo in cuoio TK  
Guapa, P47 and Sunrise collections available only in TK hide

# Cuoio Toscano - Tuscan hide

Cat. CT

Nabuk

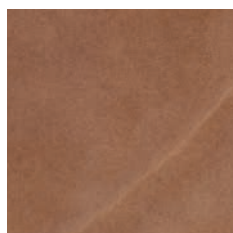

**C3M2**  
Marrone - Brown

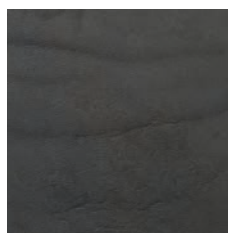

**C3N4**  
Nero - Black

Fiore

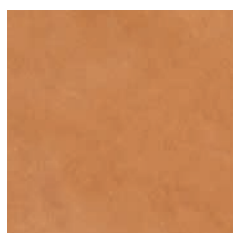

**C3N2**  
Naturale - Natural



**C3CU**  
Cuoio - Hide

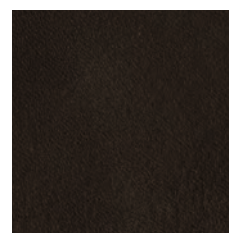

**C3T4**  
Testa di moro - Dark brown

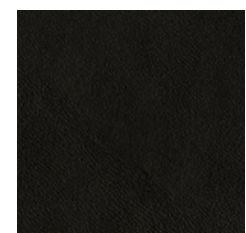

**C3N5**  
Nero - Black

# Plastica - Plastic

Polipropilene - Polypropylene

Cat. PPI

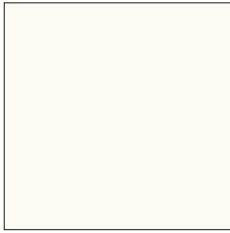

**PB4**  
Bianco - White



**PS2**  
Sabbia - Sand

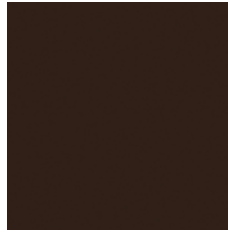

**PM2**  
Marrone - Brown

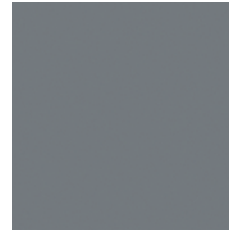

**PGU**  
Grigio cielo - Sky grey



**PGD**  
Grigio grafite - Graphite grey

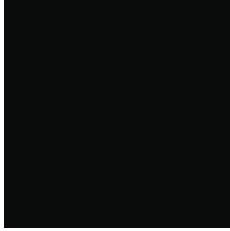

**PN4**  
Nero - Black

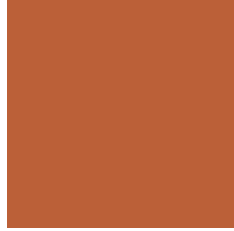

**PT2**  
Terracotta



**PRS**  
Rosso bulgaro - Bulgaro red



**PRR**  
Rosso - Red



**PO2**  
Giallo ocra - Ocher yellow



**PVL**  
Verde scuro - Dark green

# Plastica - Plastic

Baydur

Cat. PB1 - PB2



Cat. PB1

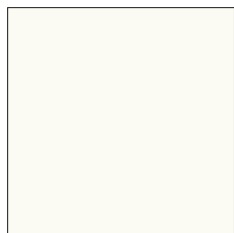

**BB4**  
Bianco - White

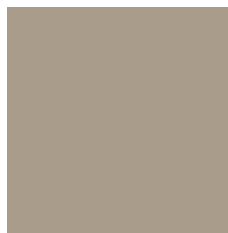

**BGS**  
Grigio cenere - Ash grey

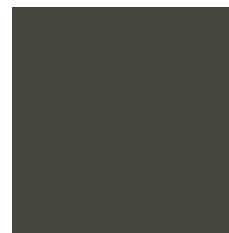

**BGW**  
Grigio scuro - Dark grey

Cat. PB2



**CGT**  
Cemento spatolato  
grigio chiaro - Light grey  
troweled concrete

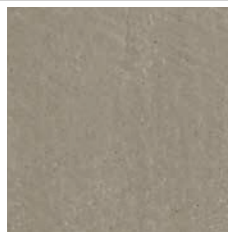

**CGW**  
Cemento spatolato  
grigio scuro - Dark grey  
troweled concrete

# Metallo - Metal

Cat. M1 - M2

Cat. O1 - O2



Cat. M1

Cat. O1



**BB**  
Bianco - White

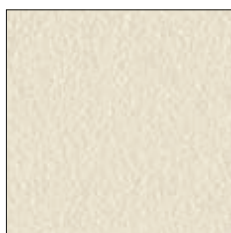

**EF**  
Bianco perla - White pearl

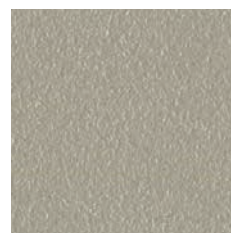

**EC**  
Corda - Sand

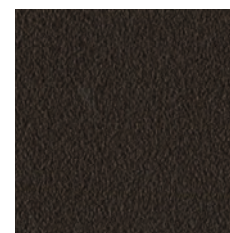

**E6**  
Marrone - Brown

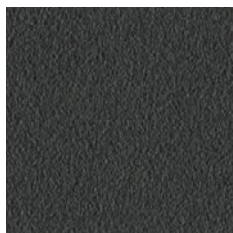

**EG**  
Grafite - Graphite

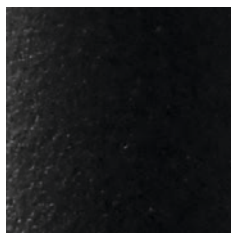

**EN**  
Nero - Black

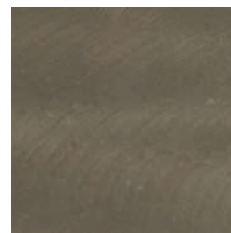

**E5 \***  
Industrial

Cat. M2

Cat. O2



**EH**  
Blu turchese - Blue turquoise

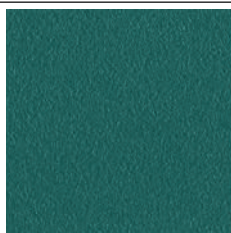

**EJ**  
Verde pino - Pine green

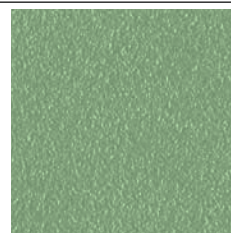

**E9**  
Verde salvia - Sage green

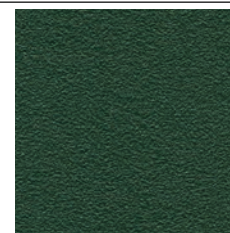

**EL**  
Verde scuro - Dark green

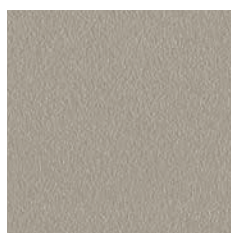

**ES**  
Grigio cenere - Ash grey



**ET**  
Grigio chiaro - Light grey



**EO**  
Azzurro - Light blue



**EE**  
Blu zaffiro - Blue Sapphire



**EI**  
Blu oceano - Ocean blue



**E3**  
Fango - Fango



**E2**  
Bronzo - Bronze



**E7**  
Giallo ocre - Ocher yellow



**EO**  
Giallo oro - Golden yellow



**E4**  
Giallo pastello - Pastel yellow



**E8**  
Rosa cipria - Facepowder pink



**EA**  
Arancio papaya - Papaya orange



**ER**  
Rosso - Red



**EQ**  
Rosso ciliegia - Cherry red



**FP**  
Rosso bulgaro - Bulgaro red

\* Non disponibile versione outdoor - Outdoor version not available

## Cat. M3



**CC**  
Cromo - Chrome

## Cat. M4



**DR**  
Oro rosa - Pink gold



**DB**  
Bronzo dorato - Golden bronze



**DG**  
Oro champagne - Champagne gold



**DZ**  
Nichel nero - Black nickel



**DY**  
Nichel nero opaco - Matt black nickel



**DC**  
Bronzo dorato opaco - Matt golden bronze

## Cat. M5



**HL**  
Inox lucido - Polished stainless steel



**HS**  
Inox satinato - Satin stainless steel

# Nobilitato - Ennobled

Cat. HL1

Melaminico - Melamine

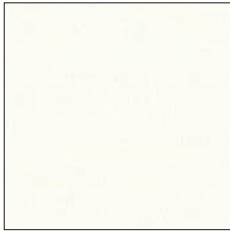

**M01**  
Bianco - White



**M07**  
Corda - Sand

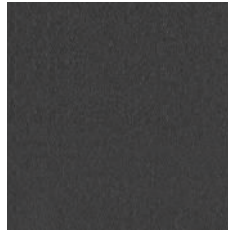

**M02**  
Grafite - Graphite



**M04**  
Nero - Black

# Stratificato - Stratified

Cat. HH3

HPL soft touch

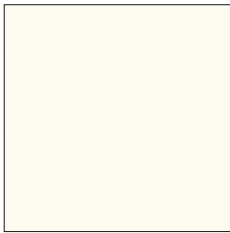

**AB4**  
ST bianco - ST white



**ACR**  
ST Corda - ST sand



**AGD**  
ST grigio grafite - ST  
graphite grey



**AN4**  
ST nero - ST black



**ATR**  
ST tortora



**FAM**  
ST rosso namib - ST red  
namib



**FGO**  
ST giallo evora - ST yellow  
evora

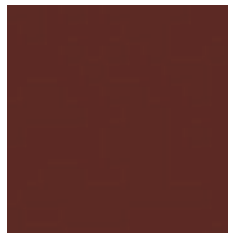

**FRB**  
ST rosso bulgaro - ST red  
bulgaro

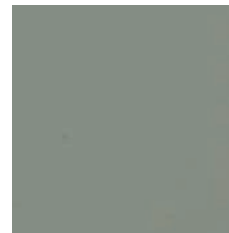

**FVK**  
ST verde kitami - ST green  
kitami

# Stratificato - Stratified

Cat. HH1 - HH2 - HH3



HPL

Cat. HH1



**HB4**  
Bianco - White



**HN4**  
Nero - Black

Cat. HH2



**HC6**  
Grigio cemento -  
Concrete grey



**HGW**  
Grigio scuro - Dark grey



**HC7**  
Corten

# Legno - Wood

Cat. LM1

MDF laccato - Lacquered MDF

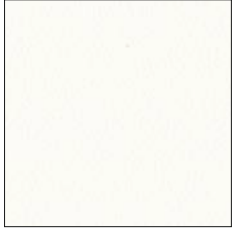

**G05**  
Bianco - White



**G07**  
Corda - Sand

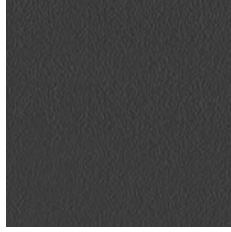

**G02**  
Grigio grafite - Graphite grey



**G41**  
Marrone - Brown

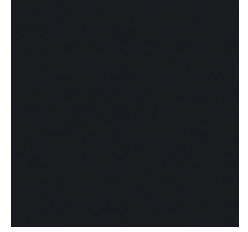

**G04**  
Nero - Black

# Legno - Wood

Cat. LF1

Frassino tinto - Lacquered ash



**F40**  
Tinto naturale - Stained natural

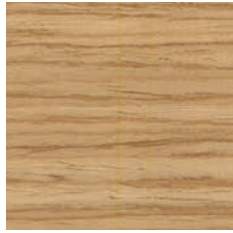

**F52**  
Tinto rovere naturale - Stained natural oak



**F26**  
Tinto moro - Stained dark brown



**F24**  
Tinto noce fiammato - Stained flamed walnut



**F60**  
Tinto sbiancato - Lacquered whitened



**F61**  
Tinto deserto - Lacquered desert



**F62**  
Tinto grigio chiaro - Lacquered light grey



**F63**  
Tinto grigio scuro - Lacquered dark grey



**F09**  
Tinto rosso ciliegia - Stained red cherry

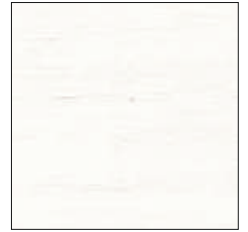

**F05**  
Tinto bianco - Stained white



**F04**  
Tinto nero - Stained black

# Legno - Wood

Cat. LI1 - LI2

Impiallacciato tinto - Stained veneer

## Cat. LI1

Essenza: frassino  
Essence: ash



**140**  
Tinto naturale - Stained natural

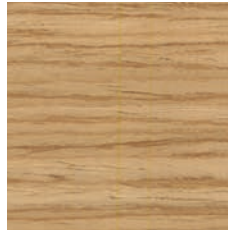

**152**  
Tinto rovere naturale - Stained natural oak



**126**  
Tinto moro - Stained dark brown



**160**  
Tinto sbiancato - Lacquered whitened

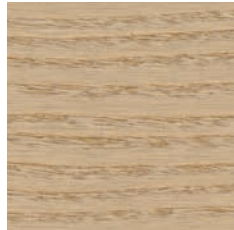

**161**  
Tinto deserto - Lacquered desert

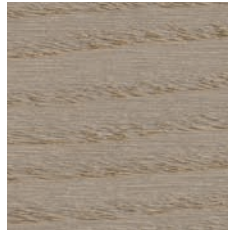

**162**  
Tinto grigio chiaro - Lacquered light grey

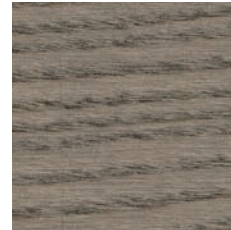

**163**  
Tinto grigio scuro - Lacquered dark grey



**109**  
Tinto rosso ciliegia - Stained red cherry



**105**  
Tinto bianco - Stained white



**104**  
Tinto nero - Stained black

## Cat. LI2

Essenza: noce  
Essence: walnut

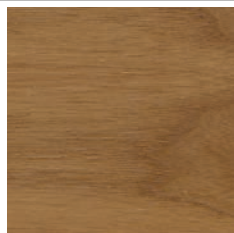

**124**  
Fiammato - Flamed

Essenza: rovere  
Essence: oak

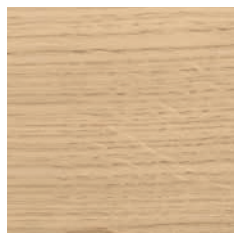

**122**  
Naturale - Natural

# Legno - Wood

Cat. LS1 - LS2

Massello - Solid wood

Cat. LS1



**WR1**  
Rovere bordo dritto  
Oak straight edge

---

Cat. LS2



**WN1**  
Noce bordo corteccia  
Walnut bark edge

## Cat. GVB

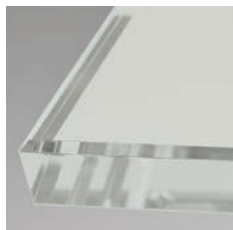

**J01**  
Trasparente extra chiaro  
Extra clear transparent

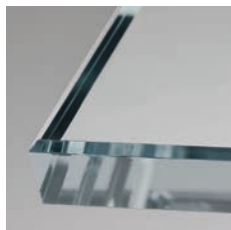

**J21**  
Lucido extra chiaro bianco  
Extra clear glossy white

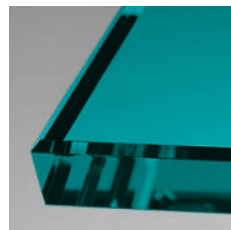

**J27**  
Lucido extra chiaro blu turchese  
Extra clear glossy blue turquoise

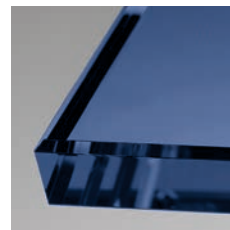

**J26**  
Lucido extra chiaro blu zaffiro  
Extra clear glossy blue sapphire

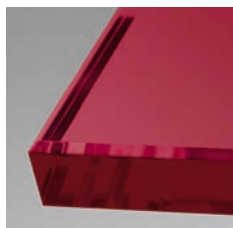

**J25**  
Lucido extra chiaro rosso ciliegia  
Extra clear glossy cherry red

## Cat. GVC

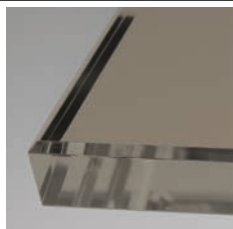

**J32**  
Satinato antigraffio corda  
Matt sand antiscratch

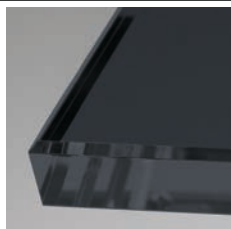

**J31**  
Satinato antigraffio grafite  
Matt graphite antiscratch

## Cat. GVD

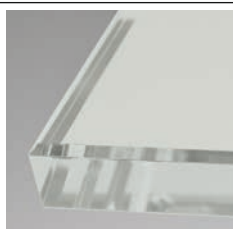

**J41**  
Satinato antigraffio extra chiaro bianco  
Extra clear matt white antiscratch

## Cat. GVE

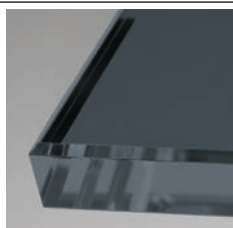

**J05**  
Lucido fumè  
Glossy fumè

## Cat. GVH

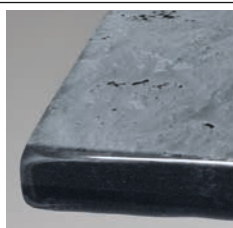

**J50**  
Bucciato fumè

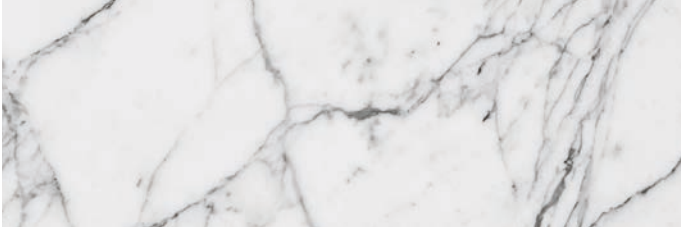

**MB4**  
Bianco Calacatta Vagli - White Calacatta Vagli



**MB2**  
Beige Travertino Romano

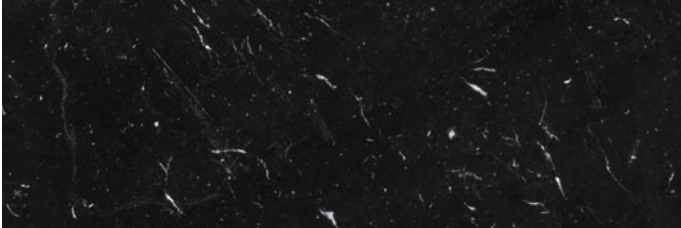

**MN4**  
Nero Marquinia

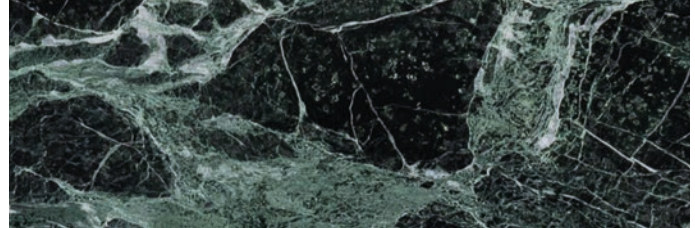

**MVE**  
Verde Tinos - Green Tinos

## Cat. GKA



**K12**  
Savoia cemento - Savoia concrete

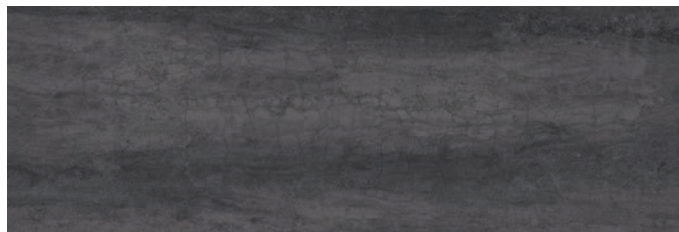

**K11**  
Savoia antracite - Savoia charcoal

---

## Cat. GKB

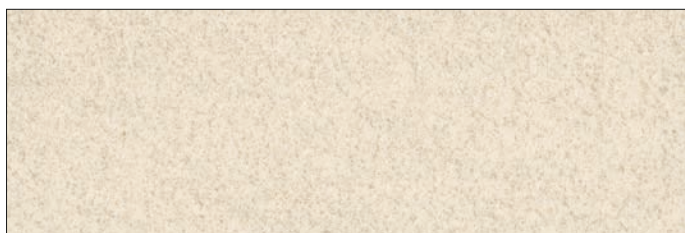

**K24**  
Calce bianco - Lime white

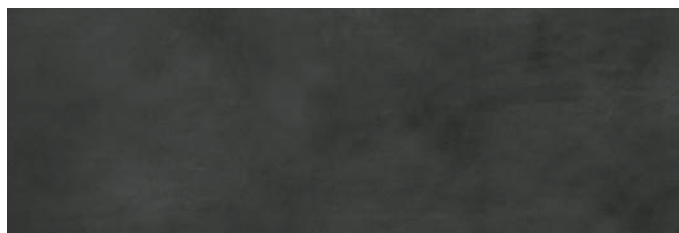

**K25**  
Calce nero - Calce black

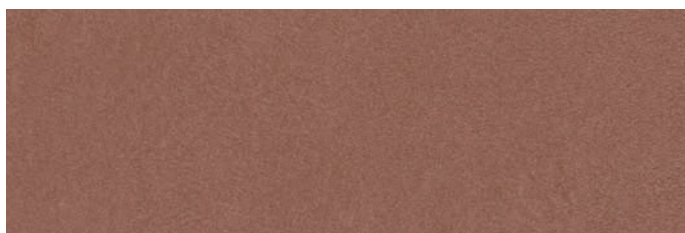

**K90**  
Terracotta opaco - Terracotta matt

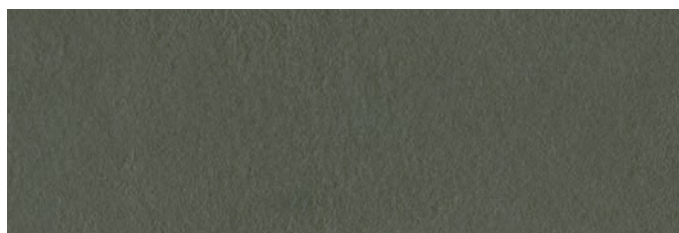

**K91**  
Verde opaco - Green matt

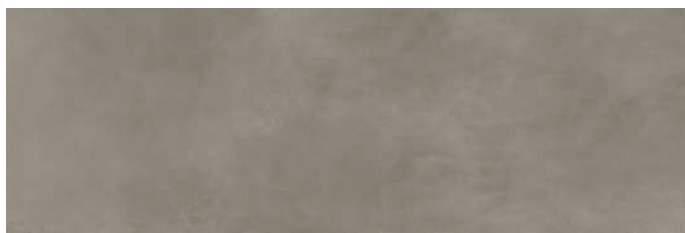

**K26**  
Calce tortora

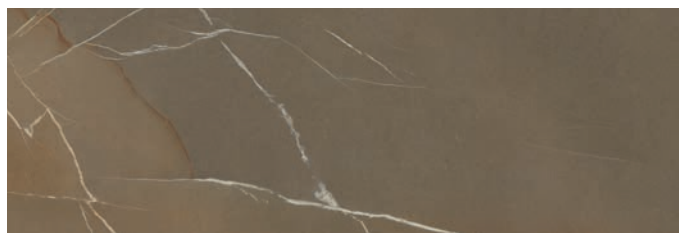

**K55**  
Pietra piacentina taupe materica - Piasentina stone taupe materico



**K32**  
Marmo lucido Calacatta - Glossy white Calacatta marble



**K42**  
Marmo opaco Calacatta - Matt Calacatta marble



**K47**  
Marmo statuario bianco opaco - Marble statuario white matt



**K46**  
Marmo opaco verde Tinos - Tinos green matt marble

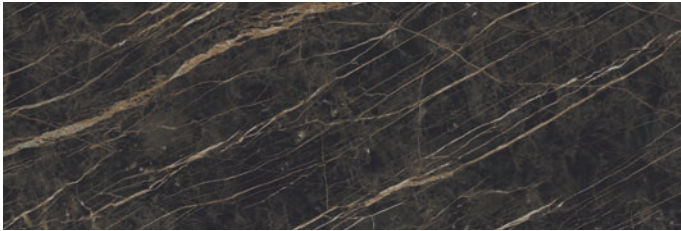

**K35**  
Marmo lucido Noir Desir - Noir Desir glossy marble

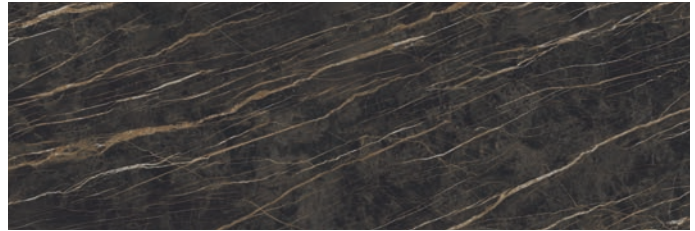

**K45**  
Marmo opaco Noir Desir - Matt Noir Desir marble



**K33**  
Marmo lucido greco nero - Glossy Greek black marble



**K50**  
Marmo calacatta nero bocciardato - Marble calacatta black bush hammered





Midj S.p.A. reserves the right to modify its equipment at any time without updating this manual. The colors shown are for guidance only and may be different than the reality.

All the priced listed on the price list are VAT excluded.

All the products which are inside Midj catalogues and not included in the current price list are to be consider out of production.

All rights reserved.



Il marchio della gestione forestale responsabile

Only the products that are identified as such on this document are FSC certified

price list 25

MIDJ S.p.A.  
Via Madonna di Campagna2/A  
33075 Cordovado (PN) - Italy  
T +39.0434690122  
F +39.0434690202  
www.midj.com  
info@midj.com



DESIGN IS A WONDERFUL LIFE

MIDJ.COM

