

# Office and Public Space

**intuit**  
BY SOFTREND

Furniture Collection 2026

## SEATING & WORKSATIONS

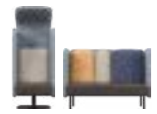

August  
pg 28



August Workbay  
pg 36



August Nook  
pg 42



August Wall  
pg 46



Ben  
pg 50



Don  
pg 54



Frankie  
pg 58



Harles  
pg 66



Hide  
pg 72



Hubert & Hubert Mini  
pg 76



Intro  
pg 80

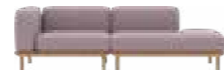

Kimi  
pg 82



Lilja  
pg 88



Loop, Duo & Twin  
pg 94



Meeter Modular  
pg 96



Meeter Round  
pg 106



Meeter Sofa & Armchair  
pg 110



Meeter Workbay  
pg 116



Meeter Chair  
pg 122



Sans  
pg 124



Sofi  
pg 136



Spot  
pg 140



Wander  
pg 146

## PHONE POD



Intuit Booth  
pg 152

## TABLES



Aide  
pg 156



Alfred  
pg 160



Flow  
pg 162



Kuubik  
pg 166



Kuubik Side Table  
pg 170



Rolf  
pg 172

## SCREENS, SPACE DIVIDERS & WALL PANELS



Grow  
pg 174



Hover  
pg 178



Note  
pg 184



Silent Note  
pg 186



Oaas  
pg 188



Sigmund  
pg 194



Sprout  
pg 196

# CONTENTS

## Intro

Environment matters	2
From Tradition to Innovation: the Intuit story	14
Intuit by Softrend and Sustainability	16
Sound-absorbing furniture	24

## Collection

### Seating & workstations

August	28
August Workbay	36
August Nook	42
August Wall	46
Ben	50
Don	54
Frankie	58
Harles	66
Hide	72
Hubert & Hubert Mini	76
Intro	80
Kimi	82
Lilja	88
Loop, Duo & Twin	94
Meeter Modular	96
Meeter Round	106
Meeter Sofa & Armchair	110
Meeter Workbay	116
Meeter Chair	122
Sans	124
Sofi	136
Spot	140
Wander	146

### Phone pod

Intuit Booth	152
--------------	-----

### Tables

Aide	156
Alfred	160
Flow	162
Kuubik	166
Kuubik Side Table	170
Rolf	172

### Screens, space dividers & wall panels

Grow	174
Hover	178
Note	184
Silent Note	186
Oaas	188
Sigmund	194
Sprout	196

### Fabrics

Standard Fabric Collection	202
----------------------------	-----

# ENVIRONMENT MATTERS

At Intuit by Softrend, we understand that environments matter. Whether it's in the office or public spaces like educational facilities, libraries, cafeterias or public waiting areas, our furniture designs are crafted not only to fill spaces but to transform them. We believe in creating settings that nurture creativity, foster collaboration, and enhance productivity, making every space intuitive and lively. Each of Intuit's furniture pieces is designed with the goal of making spaces more adaptable, functional, and appealing. At Intuit by Softrend, we're committed to redefining how furniture interacts with spaces and its users.



# INTUITIVE FURNISHING FOR GETTING THINGS DONE



Our way of working has changed. It's the creative problem solving, agile collaboration, and the feeling of community we search for in the office. Intuit's designs have evolved to meet this shift.

We've taken the spirit of the breakout space and divided it into 4 distinctive work zones — each designed to meet a particular need to encourage creativity and connection.

Our 4 Zones use modular and multi-functional furniture solutions to make the most of every area of the office. Providing alternate spaces to choose where to work within the office drives a more effective workspace, a better work experience, and better individual performance. A win-win!

The world is moving fast — with Intuit, you make sure office space can keep up.



Welcome Zone



Social Zone



Collaboration Zone



Concentration Zone

INTUITIVE OFFICE



## INSPIRING LEARNING SPACES

At Intuit, we understand that effective learning environments extend beyond the traditional classroom setup of desks and chairs. Our vision is to create versatile spaces that cater to every aspect of the educational journey — from quiet study areas equipped with screens to dynamic group workspaces and comfortable lounges for relaxation and social interaction.

Our range of school furniture is designed to enrich learning experiences across all educational stages, from kindergartens to universities. We prioritize well-being for users of all ages and sizes, ensuring our furniture combines timeless design with functionality. Built to last, our pieces boast durable structures and are easy to maintain, making them a smart investment for long-lasting learning environments.

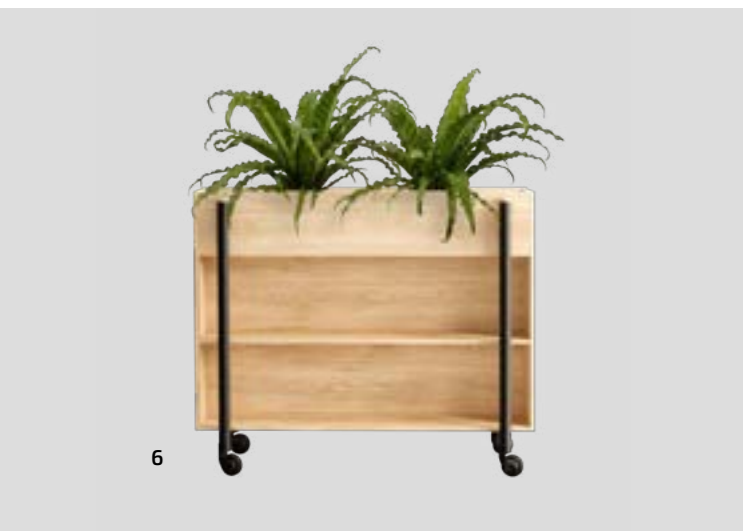

## TRANSFORMING THE WORKPLACE CAFÉ INTO A DYNAMIC HUB

At Intuit, we believe a contemporary workplace café does more than just serve food; it enriches the entire workplace experience. Far from being just a corporate eatery, it's a dynamic, multifunctional hub where employees can dine, meet, work, network, socialize, and reenergize. By activating underutilized spaces throughout the working day, it plays a crucial role in fostering employee productivity and well-being.





## ELEVATING THE LIBRARY SPACE

In the heart of every library, from the quiet corners of reading nooks to the collaborative buzz of communal spaces, the right seating can transform the experience. Intuit's range of library seating furniture is designed to meet every need— whether it's for individual study, group projects, or leisurely reading.

At Intuit, we believe in the power of timeless design, durability, and ease of maintenance to create inviting, long-lasting reading and learning environments. Discover seating solutions that cater to the diverse requirements of modern libraries, ensuring every visitor finds their perfect spot.

## ENHANCING TRANSIT SPACES INTO WELCOMING HUBS

The quality of waiting areas, whether in airports, hospital lobbies, conference centers, or large office buildings, significantly impacts user experience. Our approach to designing for these spaces centers on transforming mere transit areas into inviting hubs that offer comfort and function while waiting.

Inuit's public space collection is crafted to elevate waiting areas into more than just pass-through spaces; they become places where visitors can relax in comfort, catch up on work, or enjoy a peaceful moment away from the hustle and bustle. With Intuit's furniture, waiting becomes an experience in itself, characterized by style, comfort, and utility.



# FROM TRADITION TO INNOVATION: THE INTUIT STORY

## Rooted in Craftsmanship

Intuit by Softrend carries forward a legacy of over 25 years in the furniture industry, grounded in three generations of craftsmanship. Born from the established residential furniture brand Softrend, our journey began in a modest factory in Vääna, Estonia, where every sofa and bed is still handcrafted with precision. By managing every step of the production process, from meticulous quality control to extensive customization options, we uphold the highest standards. Our management system's adherence to ISO 9001:2015 and 14001:2015 reflects our commitment to consistent quality and environmental management.

## Innovating for Tomorrow

With a foundation deeply rooted in Softrend's extensive experience, Intuit by Softrend was launched in 2016 to revolutionize the public space furniture sector. We infuse a spirit of curiosity and innovation into Softrend's traditional expertise, creating functional, sustainable, and stylish furniture.

## Sustainability at the Core

At Intuit, sustainability isn't just a policy; it's a promise to our customers and the planet. We carefully select recyclable materials free from harmful chemicals, focusing on durable design to prolong the life of our products and lessen our environmental impact. Our design philosophy emphasizes product longevity, recyclability, and resource efficiency, ensuring that each piece not only serves its purpose but also contributes positively to the environment.

## Quality and Value

Our mission is to offer high-quality, durable designer furniture at fair prices, ensuring that while our prices are competitive, the quality and craftsmanship remain uncompromised. We believe that a quality product not only lasts longer but also provides greater value over time.

## Vision for the Future

Intuit is driven by a vision to enhance the daily lives of millions by creating the world's most inspiring and comfortable environments. Whether it's transforming offices into collaborative spaces or furnishing public areas like airports and hospitals, our goal is to make every environment a place where it's good to be. Our products are designed to nurture creativity, foster collaboration, and enhance productivity, ensuring that every space we touch is intuitive and vibrant.



THREE GENERATIONS  
OF FURNITURE-  
MAKING TRADITIONS  
SINCE 1997



# INTUIT BY SOFTREND AND SUSTAINABILITY

A growing number of informed consumers seek to make sustainable choices – but they can only do so if manufacturers make them possible. That's why Intuit by Softrend is steadfastly committed to sustainability, believing it's the only way to remain a responsible furniture manufacturer.

We recognize that the furniture industry has a significant environmental footprint. That's why we're taking action to reduce ours across the entire lifecycle of Softrend Group's products.

- 1 Reducing environmental impact by prioritizing chemical-free and recyclable materials.
- 2 Enhancing recyclability by considering the reuse of materials and components from the design phase.
- 3 Extending product lifespans and minimizing the need for replacement by designing durable, repairable products.
- 4 Lowering our ecological footprint through optimized storage, transport, resource efficiency, and weight reduction.

## PRIORITIES OF SOFTREND'S SUSTAINABILITY STRATEGY

Softrend's vision of sustainability relies on three principles, originating from **United Nations' Sustainable Development Goals**.

Environment	Social responsibility	Management
<ul style="list-style-type: none"> <li>• Climate change</li> <li>• Circular economy</li> </ul>	<ul style="list-style-type: none"> <li>• Consumer health and safety</li> <li>• Labor policies for value chain employees</li> <li>• Employee wellbeing</li> </ul>	<ul style="list-style-type: none"> <li>• Transparency</li> <li>• Responsible management</li> </ul>
		



## ALREADY PART OF OUR DAILY PRACTICES

### Made to order

We prevent excess stock by producing only what is needed.

### Circular product design

We design all new products for longevity. Easy to disassemble, they can be repaired, refreshed, and ultimately recycled.

### Smart material choices

We encourage our customers to choose durable materials by offering them as standard. More and more are also recyclable.

### Minimizing waste

Following ISO 1400:2015, we reduce waste, reuse what we can, and pass the rest to our partners.



A great example of circular design is the Hover soft leaning wall – its top layers slide easily together and apart, making it simple to replace worn components.

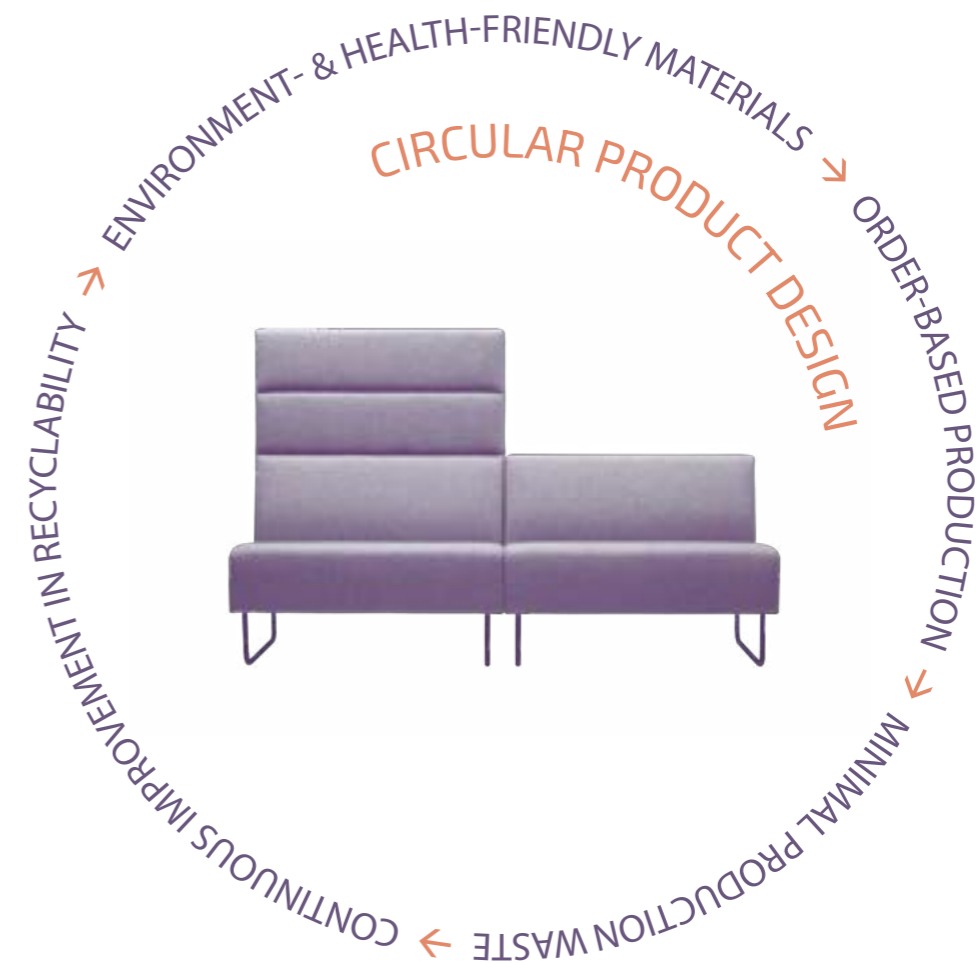

## WHERE ARE WE GOING?

### **More eco-labelled products**

Building on the success of the Meeter series, which already carries the EU Ecolabel, we plan to certify at least ten more products or product lines by the end of 2026.

### **Improved recycling**

We will increase the use of renewable and recycled materials in our products.

### **Circular economy products**

All future products will follow circular design principles, and we will update most existing designs accordingly.

### **More sustainable packaging**

We will prioritize recyclable transport packaging and reduce plastic use.

### **Enhanced governance & business ethics**

We ensure a safe, supporting work environment while maintaining ethical and transparent business practices.



## EU ECOLABEL AND OUR PRODUCTS

The EU Ecolabel guarantees that a product is made in an environmentally and health-friendly way, has a long lifespan, and can be safely recycled. We are applying for Ecolabels for our products to help customers make more sustainable choices.

### Environment

The raw wood, cork, bamboo, or rattan used in Ecolabelled products comes from sustainably managed forests.

### Health

Ecolabelled furniture is produced without the use of hazardous chemicals, ensuring safety for everyone who comes into contact with it – both during production and use.

### Warranty

Ecolabelled products come with a long manufacturer's guarantee, reflecting their high quality and exceptional durability.

### Sustainability

Ecolabelled furniture is easy to dismantle, repair, and refresh – for example, by replacing the fabric and foam. This process further extends the product's lifespan.

### Ecolabelled fabrics

Intuit offers a range of around 1,500 fabrics, over half of them carry the Ecolabel. These 724 fabrics, each with distinctive looks and versatile characteristics, come from various manufacturers and are divided into multiple price categories.

### FSC certified wood

We already use 90% FSC-certified wood in the production of Intuit's products. This certification ensures that the wood is produced with equal regard for both the environment and economic viability.



Camira Oceanic fabric range is crafted from 100% recycled polyester and plastic sourced from marine debris.

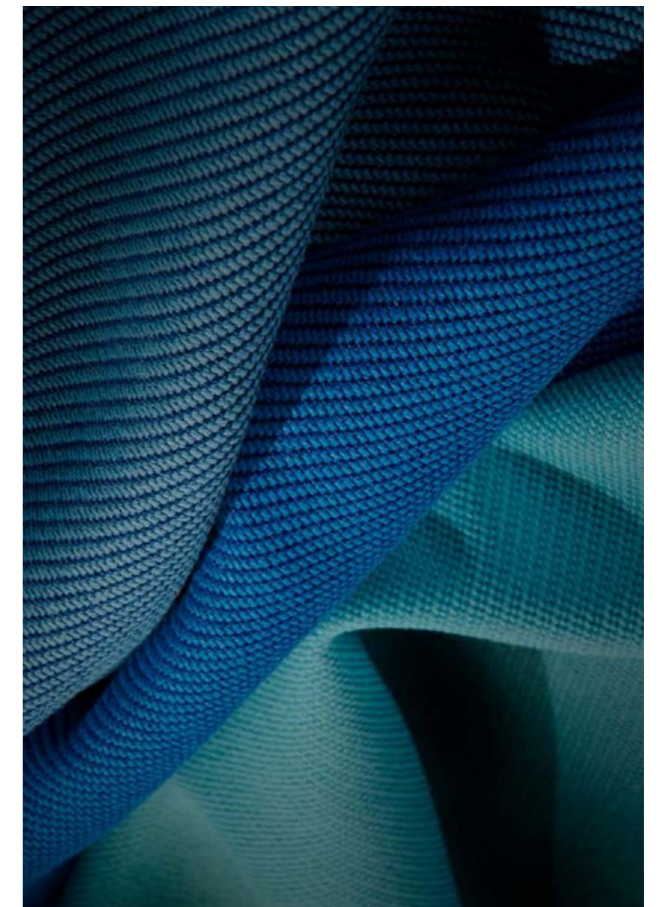

# SOUND-ABSORBING FURNITURE

Public space and open offices often have problems with resonance, meaning that sounds reverberate for too long. Sound waves cannot move freely in a closed room and bounce off the structure of the room. Some of the sound is absorbed by surfaces, while some reflects from them.

Monitoring sound absorption and achieving the recommended reverberation duration is one of the principal tasks in the acoustic design of rooms. Acoustic absorption means that sound does not reflect off a material after reaching it. That is also the principle of designing furniture with acoustic properties: furniture has to absorb the sound that would otherwise reflect back and contribute to unwelcome noise.

Creating a more pleasant environment requires us to dampen all kinds of different sounds, such as fans, people's footsteps, conversations and phone calls.

## Acoustic August

The entire August series is designed to improve office acoustics which makes it a perfect choice for an intuitive workplace. August product series gives you more absorption area in the room, e.g. better sound and less reverberance. A less reverberant room gives you better speech quality and less noise in the work environment.

The August products are rated at the highest Class A for sound attenuation. This means that they offer noise reduction equivalent to covering additional square meters of a room with 100% sound-absorbing material. The specific amount of square meters covered depends on the surface area of the chosen August model.

THE AUGUST PRODUCTS ARE RATED  
AT THE HIGHEST CLASS A  
FOR SOUND ATTENUATION



### Equivalent absorption area per object (m<sup>2</sup>Sab / object)

For example, the calculated sound absorption value for the August 2.5-Seat/H3 sofa model is 4.8m<sup>2</sup>/sab. This is comparable to completely covering an area of 4.8 m<sup>2</sup> with a material that absorbs 100% of sound. In practical terms, one August 2.5-Seat/H3 sofa provides the same noise reduction as about 12-13 sound absorber walls, each 50mm thick and covered with cloth or felt, measuring 600x600 mm.

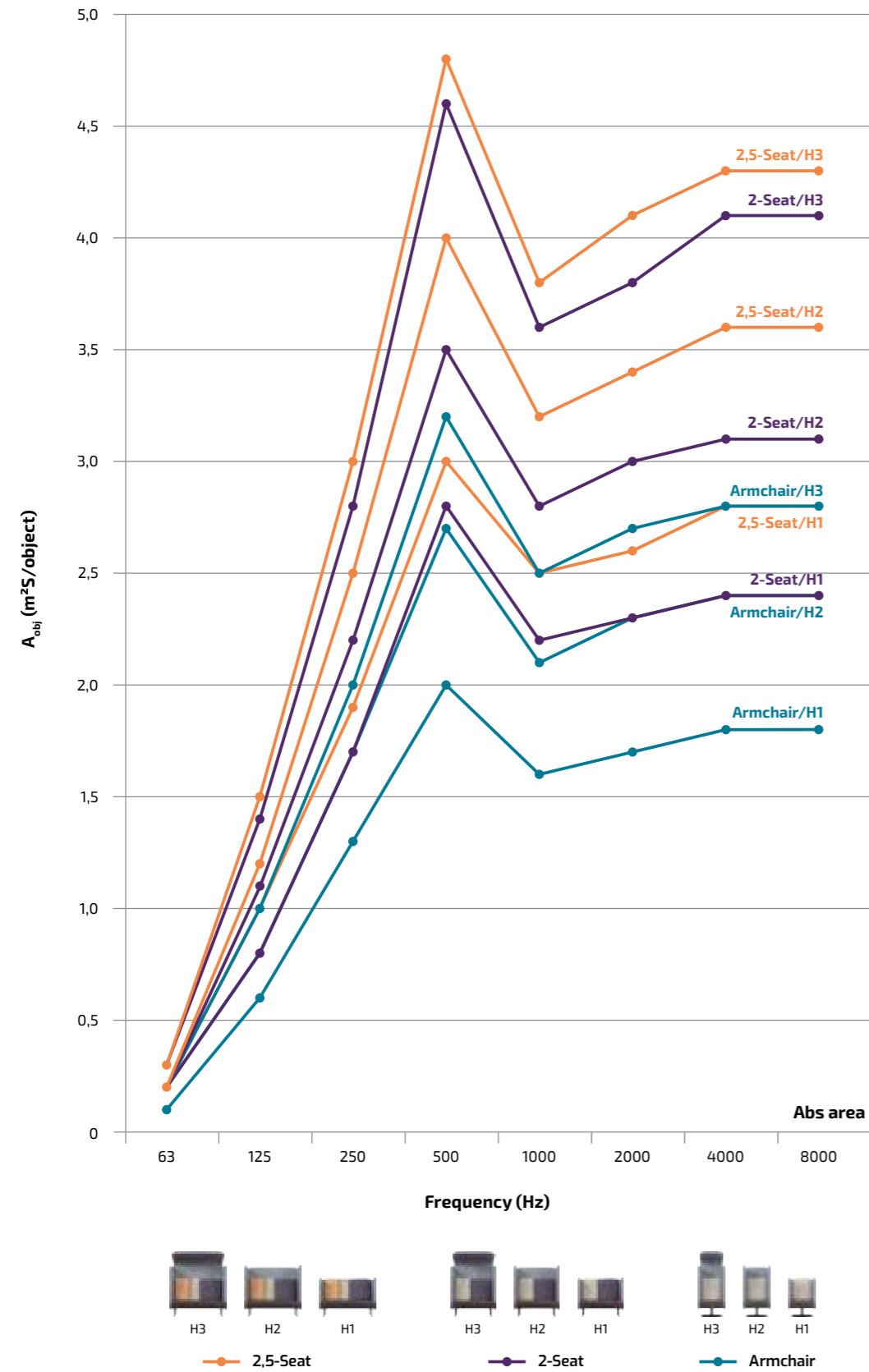

### Equivalent absorption area per object (m<sup>2</sup>Sab / object)

For example, the calculated sound absorption value for the August Workbay 2.5-Seat/H3 model is 10.7m<sup>2</sup>/sab. This is comparable to completely covering an area of 10.7 m<sup>2</sup> with a material that absorbs 100% of sound. In practical terms, one August Workbay 2.5-Seat/H3 provides the same noise reduction as about 29-30 sound absorber walls, each 50mm thick and covered with cloth or felt, measuring 600x600 mm.

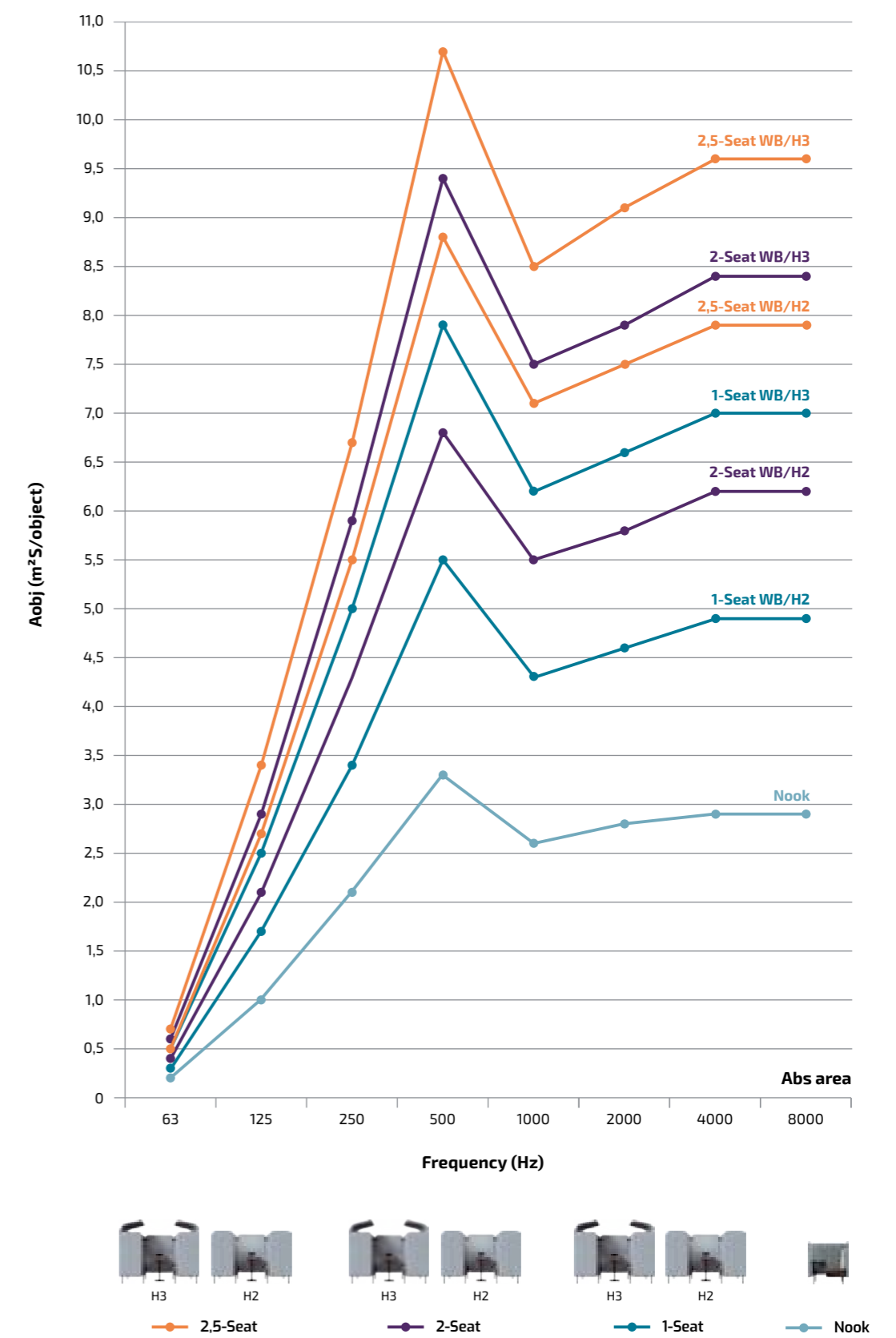

# August

Available at  
**pCon**  
 PLANNER

## Sound-absorbing sofa and armchair

Design: Pent Talvet, Iseasi

The timeless and playful August series ranks among Intuit's TOP 3 popular products. We designed the August range to perfectly address the room acoustics issues which makes it a perfect choice for an intuitive workplace. Get away from the constant distractions, and quieten the noise when it's all too much.

With sound-absorbing walls, August gives you a private oasis within even the noisiest of surroundings, and the different height options make August versatile enough for conversations in your Social Zone, or focused individual work in your Concentration Zone.



## PRODUCT INFORMATION

### Versions

Available in 3 different heights and 3 different sizes

### Acoustics

Sound absorption class A

### Legs

Available with regular legs and 360° swivel base (only for armchair)

### Accessories

Tables to add functionality to the seating area

### Electrical outlet

Under the seating attached to the frame

### Warranty

5 years

### Sustainability

Embraces the principles of circular design

### Test & Certification

- L1 European Standard strength, durability and safety certificate
- Acoustic absorption test - Class A



## STANDARD MATERIALS

### Frame

Solid wood and plywood

### Seat & backrest

Durable HR foam; fire retardant HR foam on request; fixed seat and back cushions

### Legs

Solid oak / Powder-coated metal

### Tables

Matt high-pressure laminate, or mass-colored wood fibreboard top with matt powder-coated metal legs

### Fabric upholstery

The cover material is not removable  
 Sides and rear wall of H3 models can exclusively be covered with felt fabric only

Choose any fabric from **Intuit Standard Fabric Collection**

### Additional information

As part of after-sales service we offer the change of cover fabric and all other components if needed

Vaisala office in Helsinki, Finland. Photo: Hannakaisa Pekkala



Social Zone



Concentration Zone

Encourage focus and seclusion

Host private meetings

Divide your space organically

Cut down on background noise

## LEGS



Solid oak legs, stained and varnished; anti-slip soles



Matt powder-coated metal legs; anti-slip soles



360° swivel base, powder-coated metal (only for armchair)

### Solid oak

Whitened	
Natural	
Wenge	
Black	

### Powder-coated metal

Jet Black RAL 9005	
--------------------	--

Other finishing options available on request.



Mustamäe State Gymnasium in Tallinn, Estonia. Photo: Märt Lillesiim

## TABLES



Aide table

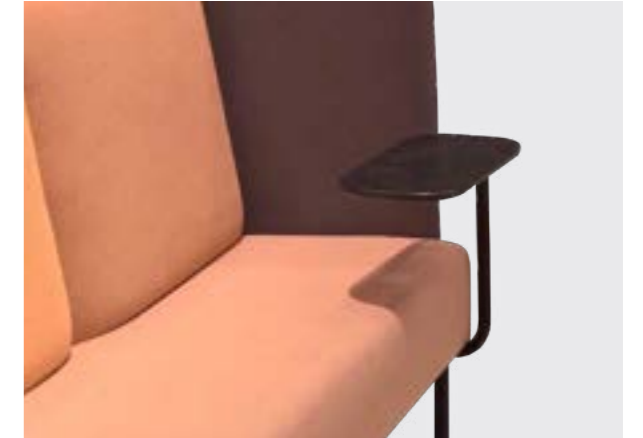

August side table

### Aide tabletop

#### High-pressure laminate

Alpine White Egger W1100 PM	
Soft Black Egger U899 PM	
Stone Green Egger U665 PM	
Garnet Red Egger U399 PM	

### Aide table legs

#### Powder-coated metal

Signal White RAL 9003	
Jet Black RAL 9005	
Tarpaulin Grey RAL 7010	
Black Red RAL 3007	

Other finishing options available on request.

### August tabletop

#### High-pressure laminate, plywood edge

Black	
-------	--

#### Mass-colored wood fibreboard

Grey	
Black	

### August table frame

#### Powder-coated metal

Jet Black RAL 9005	
--------------------	--

## ELECTRICAL OUTLET

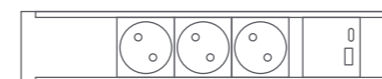

3x 220V + USB A & C

Other electrical outlet combinations available on request.

**Bachmann Power Strip**  
Color: Black

Available options DK, EU, FR, UK

## DIMENSIONS

### Armchair and sofa

Seat depth: 48 cm / Seat height: 45 cm



### Tables

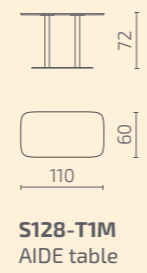

**S128-T1M**  
AIDE table

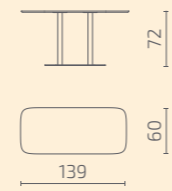

**S128-T3M**  
AIDE table

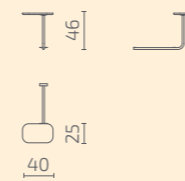

**S101-T2**  
AUGUST table

## PRICE LIST

Currency: € (VAT excl.)

PRODUCT NAME	CODE	COM/ PWF*	FABRIC CONS.	FABRIC 1	FABRIC 2	FABRIC 3	FABRIC 4	FABRIC 5
AUGUST armchair H1 (360° swivel base)	<b>S101-S1H1 (J-39)</b>	2166	6,1	2221	2408	2613	2887	3160
AUGUST armchair H2 (360° swivel base)	<b>S101-S1H2 (J-39)</b>	2341	6,9	2403	2616	2848	3157	3466
AUGUST Armchair H3 (360° swivel base)	<b>S101-S1H3 (J-39)</b>	2995	7,6	3064	3298	3553	3894	4234
AUGUST armchair H1	<b>S101-S1H1</b>	1488	6,1	1543	1731	1936	2209	2482
AUGUST armchair H2	<b>S101-S1H2</b>	1663	6,9	1726	1938	2170	2479	2788
AUGUST armchair H3	<b>S101-S1H3</b>	2318	7,6	2386	2620	2876	3216	3556
AUGUST sofa 2-Seat H1	<b>S101-S2H1</b>	2052	7,7	2121	2358	2617	2962	3307
AUGUST sofa 2-Seat H2	<b>S101-S2H2</b>	2285	9,0	2366	2644	2946	3349	3752
AUGUST sofa 2-Seat H3	<b>S101-S2H3</b>	2972	10,2	3064	3378	3721	4178	4634
AUGUST sofa 2,5-Seat H1	<b>S101-S25H1</b>	2252	9,2	2335	2618	2928	3340	3752
AUGUST sofa 2,5-Seat H2	<b>S101-S25H2</b>	2437	10,6	2533	2859	3215	3690	4165
AUGUST sofa 2,5-Seat H3	<b>S101-S25H3</b>	3494	12,2	3604	3980	4390	4936	5483
AUGUST sofa 3-Seat H1	<b>S101-S3H1</b>	2956	11,7	3062	3422	3815	4339	4864
AUGUST sofa 3-Seat H2	<b>S101-S3H2</b>	3178	13,0	3295	3695	4132	4714	5297
AUGUST sofa 3-Seat H3	<b>S101-S3H3</b>	3996	15,2	4133	4601	5112	5793	6474

\* Customer's Own Material / Price Without Fabric

TABLES	CODE	PRICE
AIDE cafeteria/work table (110x60x72 cm)	<b>S128-T1M</b>	718
AIDE cafeteria/work table (139x60x72 cm)	<b>S128-T3M</b>	728
AUGUST side table (40x25x46 cm)	<b>S101-T2</b>	440

ELECTRICAL OUTLET	CODE	PRICE
Bachmann Power Strip 3x 220V + USB A & C	<b>S114-EL1</b>	353

All dimensions provided in centimetres.



Armchair / H1



Armchair / H2



Armchair / H3



Sofa 2-Seat / H1



Sofa 2-Seat / H2



Sofa 2-Seat / H3



Sofa 2,5-Seat / H1



Sofa 2,5-Seat / H2



Sofa 2,5-Seat / H3



Sofa 3-Seat / H1



Sofa 3-Seat / H2



Sofa 3-Seat / H3

# August Workbay

Available at  

## Sound-absorbing workstation

Design: Pent Talvet, Iseasi

Looking for the perfect spot to have that important conversation? The August sofa set provides an easy solution for creating a workbay where you can go to get some privacy or have meetings. The August Workbay is an integral part of your Concentration Zone, providing an opportunity to step away from the noise, and find the focus you need.

The only thing it takes is to connect two August sofas or armchairs with a partition wall. Sound-absorbing qualities make it easy to carve out a space of peace and quiet within an open-plan office. Distraction-busting high sides with sound-absorbing qualities make it easy to carve out a space of peace and quiet within an open-plan surroundings.



Collaboration Zone



Concentration Zone

Divide your space organically

Cut down on background noise

Hold your own private meeting

Give the option of focus and seclusion

## PRODUCT INFORMATION

### Versions

Available in 2 different heights and 4 different sizes

### Acoustics

Sound absorption class A

### Accessories

Additional tables to add functionality to the seating area

### Electrical outlet

Integrated in the PC and TV wall

### Warranty

5 years

### Sustainability

Embraces the principles of circular design

### Test & Certification

- L1 European Standard strength, durability and safety certificate
- Acoustic absorption test - Class A



## STANDARD MATERIALS

### Frame

Solid wood and plywood

### Seat & backrest

Durable HR foam; fire retardant HR foam on request; fixed seat and back cushions

### Wall fastenings

Powder-coated metal

### Legs

Solid oak / Powder-coated metal

### Tables

Matt high-pressure laminate, or mass-colored wood fibreboard top with matt powder-coated metal legs

### Fabric upholstery

The cover material is not removable  
 Sides and rear wall of H3 models can exclusively be covered with felt fabric only

Choose any fabric from **Intuit Standard Fabric Collection**

### Additional information

As part of after-sales service we offer the change of cover fabric and all other components if needed



## LEGS



Solid oak legs, stained and varnished; anti-slip soles



Matt powder-coated metal legs; anti-slip soles

### Solid oak

Whitened	
Natural	
Wenge	
Black	

### Powder-coated metal

Jet Black RAL 9005	
--------------------	--

Other finishing options available on request.

## ELECTRICAL OUTLET

### Integrated in the PC wall

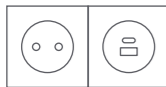

220V + USB A & C



**Berker Integro Flow**  
Color: Anthracite Matt

Available options DK, EU, FR, UK

### Integrated in the TV wall

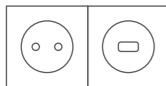

220V + HDMI



**Berker Integro Flow**  
Color: Anthracite Matt

Available options DK, EU, FR, UK



220V + USB A & C + HDMI

**Berker Integro Flow**  
Color: Anthracite Matt

Available options DK, EU, FR, UK

Other electrical outlet combinations available on request.

## TABLES



Aide cafeteria / work tables

### Aide tabletop

#### High-pressure laminate

Alpine White Egger W1100 PM	
Soft Black Egger U899 PM	
Stone Green Egger U665 PM	
Garnet Red Egger U399 PM	

### Aide table legs

#### Powder-coated metal

Signal White RAL 9003	
Jet Black RAL 9005	
Tarpaulin Grey RAL 7010	
Black Red RAL 3007	

Other finishing options available on request.



August table with plywood edge

### August tabletop

#### High-pressure laminate, plywood edge

Black	
-------	--

#### Mass-colored wood fibreboard

Grey	
Black	

### August table frame

#### Powder-coated metal

Jet Black RAL 9005	
--------------------	--

Payfit office in Paris, France



## DIMENSIONS

### Workbay

Seat depth: 48 cm / Seat height: 45 cm

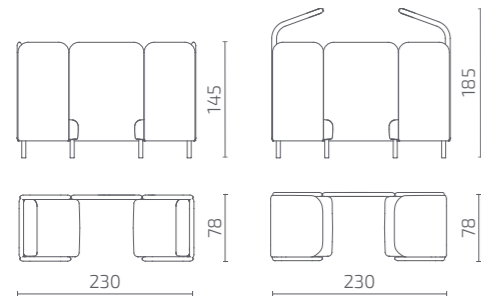

**S101-WS1H2**

**S101-WS1H3**

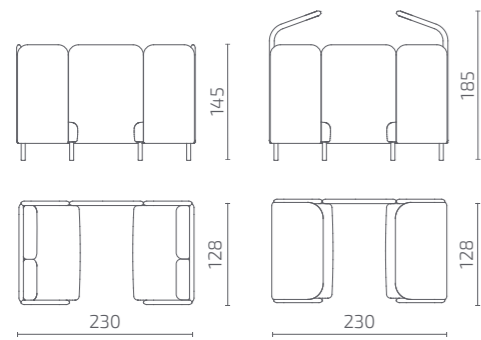

**S101-WS2H2**

**S101-WS2H3**

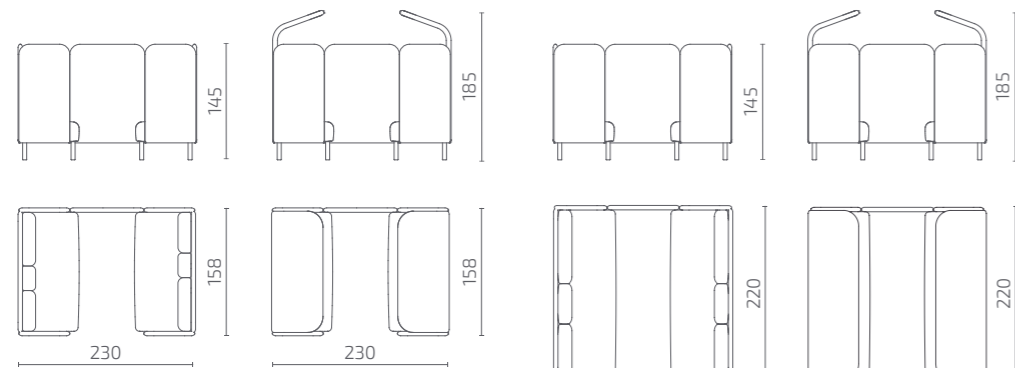

**S101-WS25H2**

**S101-WS25H3**

**S101-WS3H2**

**S101-WS3H3**

### Workbay wall

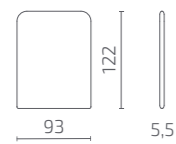

Regular wall



**S101-ELPC**  
PC integrated  
electrical outlet



**S101-ELTV**  
TV integrated  
electrical outlet

All dimensions provided in centimetres.

## PRICE LIST

Currency: € (VAT excl.)

PRODUCT NAME	CODE	COM/ PWF*	FABRIC CONS.	FABRIC 1	FABRIC 2	FABRIC 3	FABRIC 4	FABRIC 5
AUGUST Workbay 1-Seat H2	<b>S101-WS1H2</b>	3995	16,2	4141	4640	5184	5910	6636
AUGUST Workbay 1-Seat H3	<b>S101-WS1H3</b>	5310	17,6	5469	6011	6602	7391	8179
AUGUST Workbay 2-Seat H2	<b>S101-WS2H2</b>	5239	20,4	5423	6051	6737	7651	8565
AUGUST Workbay 2-Seat H3	<b>S101-WS2H3</b>	6619	22,8	6824	7526	8292	9314	10335
AUGUST Workbay 2,5-Seat H2	<b>S101-WS25H2</b>	5543	23,6	5756	6482	7275	8333	9390
AUGUST Workbay 2,5-Seat H3	<b>S101-WS25H3</b>	7664	26,8	7905	8730	9631	10831	12032
AUGUST Workbay 3-Seat H2	<b>S101-WS3H2</b>	7024	28,4	7279	8154	9108	10381	11653
AUGUST Workbay 3-Seat H3	<b>S101-WS3H3</b>	8752	32,8	9047	10058	11160	12629	14098

\* Customer's Own Material / Price Without Fabric

TABLES	CODE	PRICE
AIDE cafeteria/work table (60x60x72 cm)	<b>S128-T4M</b>	514
AIDE cafeteria/work table (110x60x72 cm)	<b>S128-T1M</b>	718
AIDE cafeteria/work table (139x60x72 cm)	<b>S128-T3M</b>	728
AUGUST work table (80x36x70 cm)	<b>S101-T1</b>	415
AUGUST work table (110x55x70 cm)	<b>S101-T3</b>	549

WALL WITH ELECTRICAL OUTLET	CODE	PRICE
PC integrated electrical outlet	<b>S101-ELPC</b>	602
TV integrated electrical outlet	<b>S101-ELTV</b>	830

### Tables



**S128-T4M**  
AIDE table



**S128-T1M**  
AIDE table



**S128-T3M**  
AIDE table



**S101-T1**  
AUGUST table



**S101-T3**  
AUGUST table

# August Nook

Available at  
**pCon**  
PLANNER

## Sound-absorbing workstation

Design: Pent Talvet, Iseasi

How do you provide a welcoming space for your hybrid workers? You need the compact 3-in-1 August Nook, with its built-in laptop size table, comfortable seat, and sound-absorbing screens.

Inviting you into a secluded spot that encourages focus and deep work, the Nook is somewhere you can slip into for an hour, or hang out in all day. Everything you need, all in one streamlined space.



Concentration Zone

Divide your space with ease

Cut down on background noise

Encourage focus and seclusion

## PRODUCT INFORMATION

### Versions

Left- or right-handed seat position

### Acoustics

Sound absorption class A

### Electrical outlet

Integrated in the table top

### Warranty

5 years

### Sustainability

Embraces the principles of circular design

### Test & Certification

- L1 European Standard strength, durability and safety certificate
- Acoustic absorption test - Class A



## STANDARD MATERIALS

### Frame

Solid wood and plywood

### Seat & backrest

Durable HR foam; fire retardant HR foam on request; fixed seat and back cushions

### Legs

Powder-coated metal

### Tables

Matt high-pressure laminate, or mass-colored wood fibreboard top with matt powder-coated metal frame

### Fabric upholstery

The cover material is not removable

Choose any fabric from **Intuit Standard Fabric Collection**

### Additional information

As part of after-sales service we offer the change of cover fabric and all other components if needed

Bornego College in Netherlands



## FINISHING OPTIONS

### Legs

#### Powder-coated metal

Jet Black RAL 9005



### Tabletop

#### High-pressure laminate, plywood edge

Black



#### Mass-colored wood fibreboard

Grey



Black



### Table frame

#### Powder-coated metal

Jet Black RAL 9005



Other finishing options available on request.

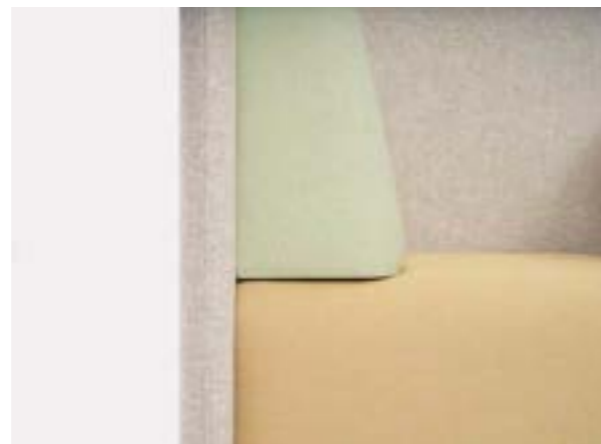

## ELECTRICAL OUTLET



**Powerdot Mini 50**  
Color: Black Matt

Available options CH, EU, FR

220V



**Powerdot Compact 61**  
Color: Black Matt

Available options EU, FR, UK

220V + USB A



**Powerdot 16**  
Color: Black Matt

Available options DK, EU, FR

220V + USB A & C

Other electrical outlet combinations available on request.

## DIMENSIONS

Seat depth: 48 cm / Seat height: 45 cm

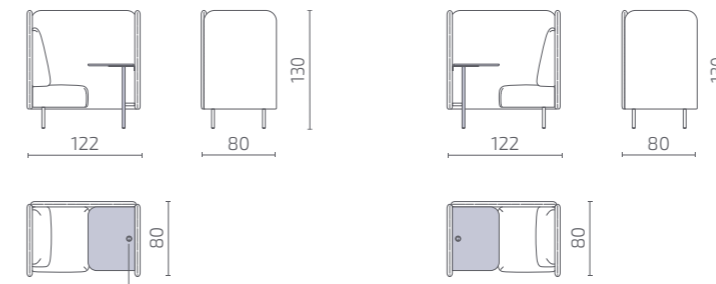

Integrated electrical outlet  
in the table top

S101-NS1L

S101-NS1R

All dimensions provided in centimetres.

## PRICE LIST

Currency: € (VAT excl.)

PRODUCT NAME	CODE	COM/ PWF*	FABRIC CONS.	FABRIC 1	FABRIC 2	FABRIC 3	FABRIC 4	FABRIC 5
AUGUST Nook 1-Seat (left seat position)	S101-NS1L	2387	8,5	2463	2725	3010	3391	3772
AUGUST Nook 1-Seat (right seat position)	S101-NS1R	2387	8,5	2463	2725	3010	3391	3772

\* Customer's Own Material / Price Without Fabric

ELECTRICAL OUTLET	CODE	PRICE
Powerdot Mini 50 1x220V	S114-EL7	81
Powerdot Compact 61 1x 220V + USB A	S114-EL4	118
Powerdot 16 1x 220V + USB A & C	S114-EL5	189

# August Wall

Available at  
**pCon**  
PLANNER

## Sound-absorbing wall panelling and bench

Design: Pent Talvet, Iseasi

Soft August Wall panels with a separate pouffe add a playful touch to the August range. Sound-absorbing panels help improve the acoustic properties of open rooms. Use the August Wall and bench combination to create areas of circulation, where colleagues can have encounters that brighten their day.



## PRODUCT INFORMATION

### Versions

Available in 2 different modules

### Warranty

5 years

### Sustainability

Embraces the principles of circular design

### Test & Certification

L1 European Standard strength, durability and safety certificate



## STANDARD MATERIALS

### Frame

Solid wood and plywood

### Seat & backrest

Durable HR foam; fire retardant HR foam on request

### Legs

Solid oak / Powder-coated metal

### Fabric upholstery

The cover material is not removable

Choose any fabric from **Intuit Standard Fabric Collection**

### Additional information

As part of after-sales service we offer the change of cover fabric and all other components if needed



Welcome Zone



Social Zone

Make your visitors feel at home

Make connections with colleagues

Cut down on background noise

## LEGS



Solid oak legs, stained and varnished; anti-slip soles



Matt powder-coated metal legs; anti-slip soles

### Solid oak

Whitened

Natural

Wenge

Black

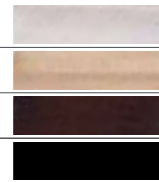

### Powder-coated metal

Jet Black RAL 9005



Other finishing options available on request.

## PRODUCT CONSTRUCTION

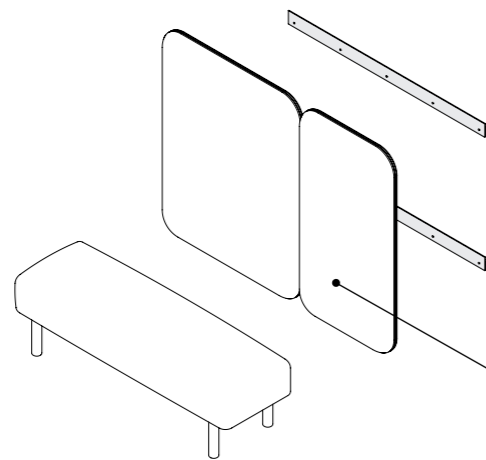
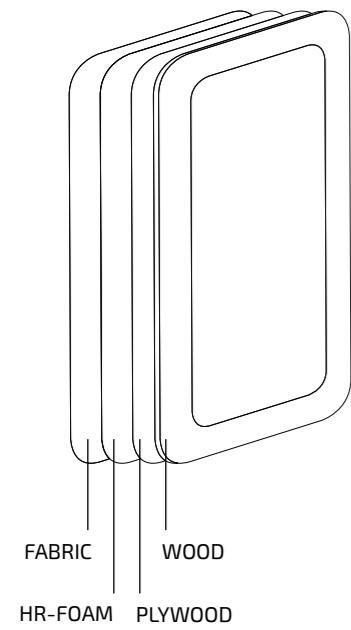

August Wall is a separate panel to be installed on the wall

## DIMENSIONS

**August bench**  
Seat depth: 48 cm

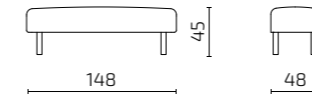

**S101-F25**

**Wall panel**

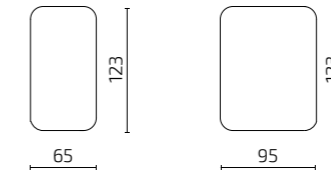

**S101-WS**

**S101-WM**

All dimensions provided in centimetres.

## PRICE LIST

Currency: € (VAT excl.)

PRODUCT NAME	CODE	COM/PWF*	FABRIC CONS.	FABRIC 1	FABRIC 2	FABRIC 3	FABRIC 4	FABRIC 5
AUGUST Bench	<b>S101-F25</b>	627	1,7	643	695	752	828	904
AUGUST Wall small	<b>S101-WS</b>	446	1,6	461	510	564	636	707
AUGUST Wall medium	<b>S101-WM</b>	530	1,6	545	594	648	720	791

\* Customer's Own Material / Price Without Fabric



# Ben

Available at  
**pCon**  
PLANNER

## Soft office sofa

Design: Intuit design team

Sometimes the best business conversations happen away from the desk. Make sure your Social Zone sparks inspiration with the Ben Sofa. With versatile modules, you can create a piece of furniture that perfectly fits your space. And with Ben's springy softness your team will enjoy building connections over coffee.

Superior in design and comfort to the breakroom chairs you're used to, Ben shows your team how much you value their comfort and wellbeing. Put the finishing touches to your Social Zone with this inviting sofa.

## PRODUCT INFORMATION

### Versions

Available in many different modules with and without armrests and 4 different pouffe sizes

### Accessories

Additional pillows, two sizes available

### Warranty

5 years

### Sustainability

Based on principles of the circular economy

### Certification



## STANDARD MATERIALS

### Frame

Solid wood and plywood, zigzag springs

### Seat and backrest

Durable HR foam; fire retardant HR foam on request

### Pillows

Feather or fibre filling

### Fabric upholstery

The cover fabric is not removable

Choose any fabric from **Intuit Standard Fabric Collection**

### Additional information

As part of after-sales service we offer the change of cover fabric and all other components if needed



Total Jobs office in Portsmouth, UK. Photo: Soren Kristensen

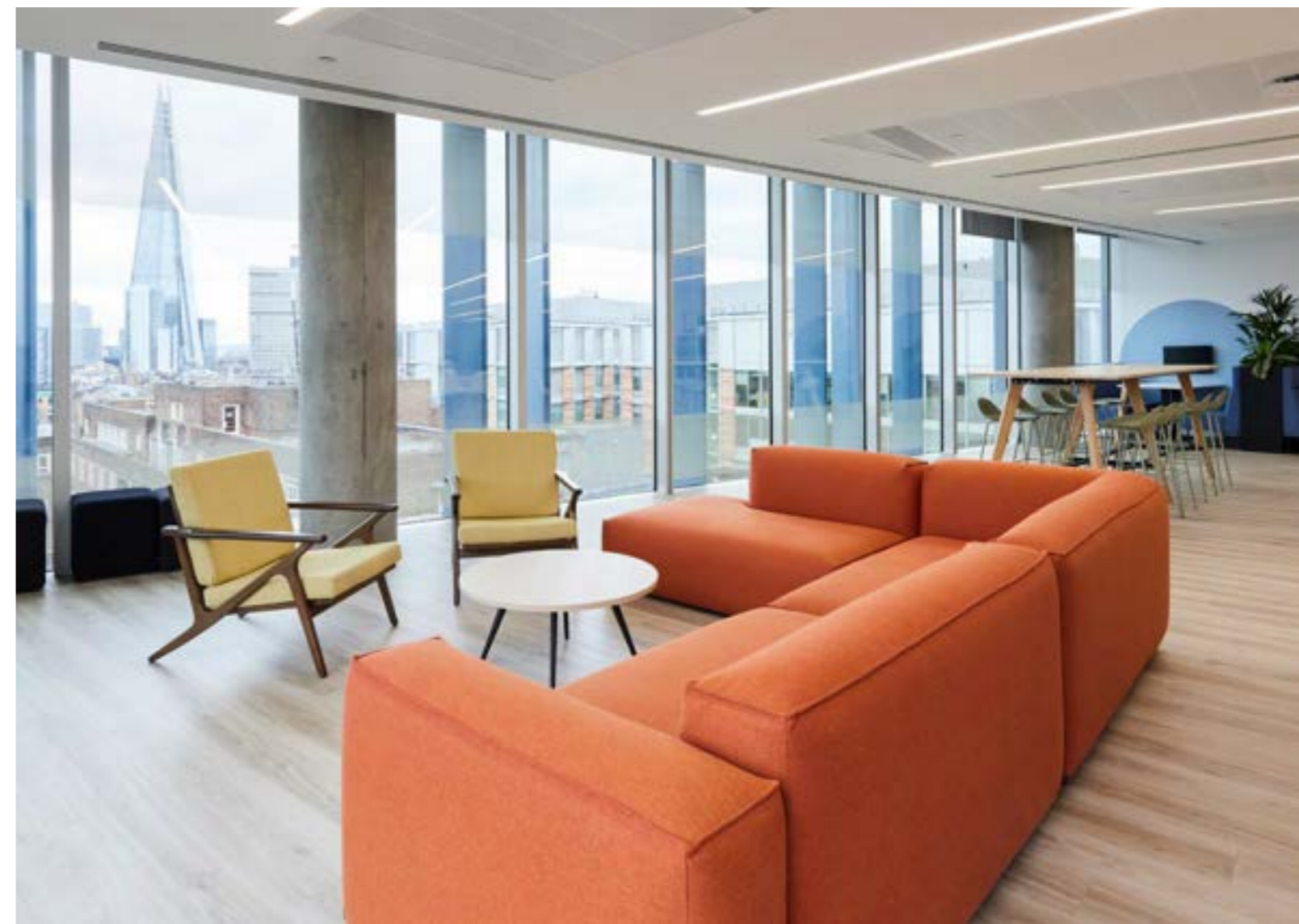

Welcome Zone



Social Zone

Take a break

Make connections with colleagues

Make your visitors feel at home

Grab moments of rest

## DIMENSIONS

### Modules

Seat depth: 58 cm / Seat height: 37 cm

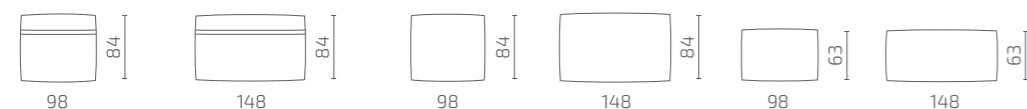
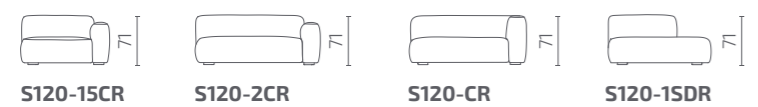
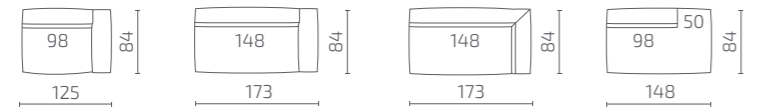
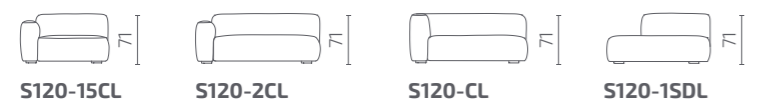
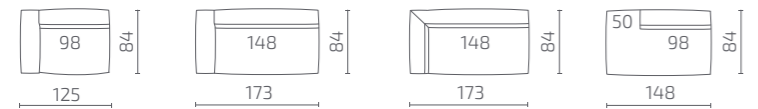
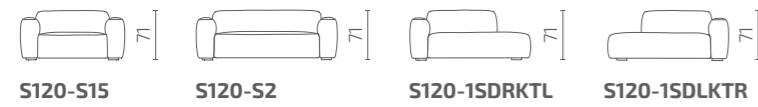
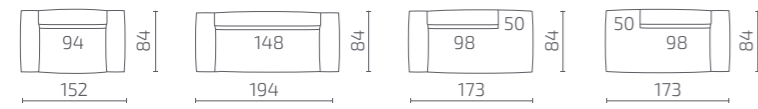

All dimensions provided in centimetres.

### SAMPLE COMBINATIONS

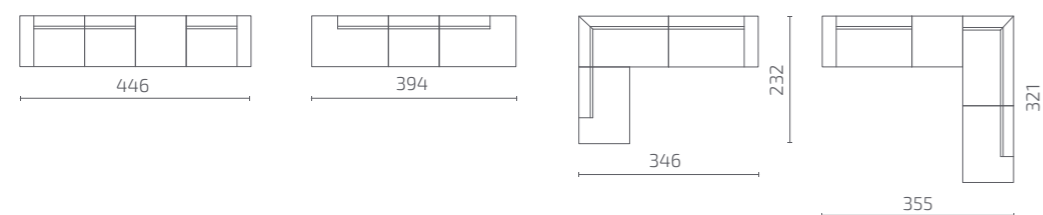
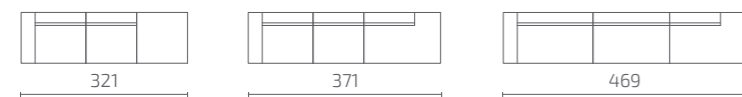
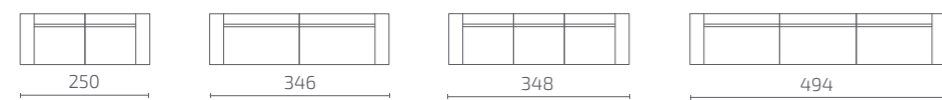

### Pillows

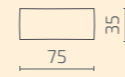

#### S120-P1

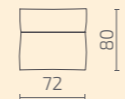

#### S120-P2

## PRICE LIST

Currency: € (VAT excl.)

PRODUCT NAME	CODE	COM/PWF*	FABRIC CONS.	FABRIC 1	FABRIC 2	FABRIC 3	FABRIC 4	FABRIC 5
BEN loveseat 1.5-Seat	<b>S120-S15</b>	1811	7,2	1876	2098	2340	2662	2985
BEN sofa 2-Seat	<b>S120-S2</b>	2133	8,6	2211	2476	2765	3150	3535
BEN separate module with armrest (left)	<b>S120-1SDRCTL</b>	1917	6,1	1971	2159	2364	2638	2911
BEN separate module with armrest (right)	<b>S120-1SDLKTR</b>	1917	6,1	1971	2159	2364	2638	2911
BEN module 1.5-Seat with armrest (left)	<b>S120-15CL</b>	1432	5,6	1483	1655	1843	2094	2345
BEN corner 1.5-Seat with armrest (right)	<b>S120-15CR</b>	1432	5,6	1483	1655	1843	2094	2345
BEN module 2-Seat with armrest (left)	<b>S120-2CL</b>	1752	7,0	1815	2030	2266	2579	2893
BEN module 2-Seat with armrest (right)	<b>S120-2CR</b>	1752	7,0	1815	2030	2266	2579	2893
BEN corner module (left)	<b>S120-CL</b>	1722	6,9	1784	1997	2229	2538	2847
BEN corner module (right)	<b>S120-CR</b>	1722	6,9	1784	1997	2229	2538	2847
BEN extended seat module (left)	<b>S120-1SDL</b>	1529	4,5	1570	1708	1860	2061	2263
BEN extended seat module (right)	<b>S120-1SDR</b>	1529	4,5	1570	1708	1860	2061	2263
BEN module 1.5-Seat	<b>S120-15</b>	1026	3,7	1060	1174	1298	1464	1630
BEN module 2-Seat	<b>S120-2</b>	1354	5,1	1400	1557	1729	1957	2186
BEN footrest 1	<b>S120-F1</b>	820	2,2	840	908	982	1080	1179
BEN footrest 2	<b>S120-F2</b>	895	3,2	924	1022	1130	1273	1417
BEN footrest 3	<b>S120-F3</b>	820	2,2	840	908	982	1080	1179
BEN footrest 4	<b>S120-F4</b>	895	3,2	924	1022	1130	1273	1417
BEN pillow small	<b>S120-P1</b>	81	1,0	90	121	154	199	244
BEN pillow large	<b>S120-P2</b>	155	1,6	170	219	273	344	416

\* Customer's Own Material / Price Without Fabric



Separate module with armrest (left)



2-Seat with armrest (left) / Corner module (left) / Extended seat module (right)



2 x Footrest 4 / Extended seat module (right)



1.5-Seat with armrest (left) / 1.5-Seat with armrest (right)

# Don

Available at  
**pCon**  
PLANNER

## Soft office sofa

Design: Intuit design team

While the lounge couch Ben serves as the focal point of the Social Zone, creating a comfortable space for colleagues to take a break from work, its larger counterpart, Don, elevates these breaks to a whole new level.

Don is as springy and as elegantly designed as Ben, but with a slightly deeper seating area, which adds a luxurious look and makes things more comfortable. Now everyone can get cosy and enjoy lying down, including four-legged members of the office.

## PRODUCT INFORMATION

### Versions

Available in many different modules with and without armrests and 3 different pouffe sizes

### Accessories

Additional pillows, two sizes available

### Warranty

5 years

### Sustainability

Based on principles of the circular economy

### Certification



## STANDARD MATERIALS

### Frame

Solid wood and plywood, zigzag springs

### Seat and backrest

Durable HR foam; fire retardant HR foam on request

### Pillows

Feather or fibre filling

### Fabric upholstery

The cover fabric is not removable

Choose any fabric from **Intuit Standard Fabric Collection**

### Additional information

As part of after-sales service we offer the change of cover fabric and all other components if needed



Welcome Zone



Social Zone

Offer a spacious and comfortable seating area

Make guests feel at home

A great place to befriend colleagues

Lithuanian Railway office in Vilnius, Lithuania. Photo: Lukas Jusas



## DIMENSIONS

### Modules

Seat depth: 72 cm / Seat height: 37 cm

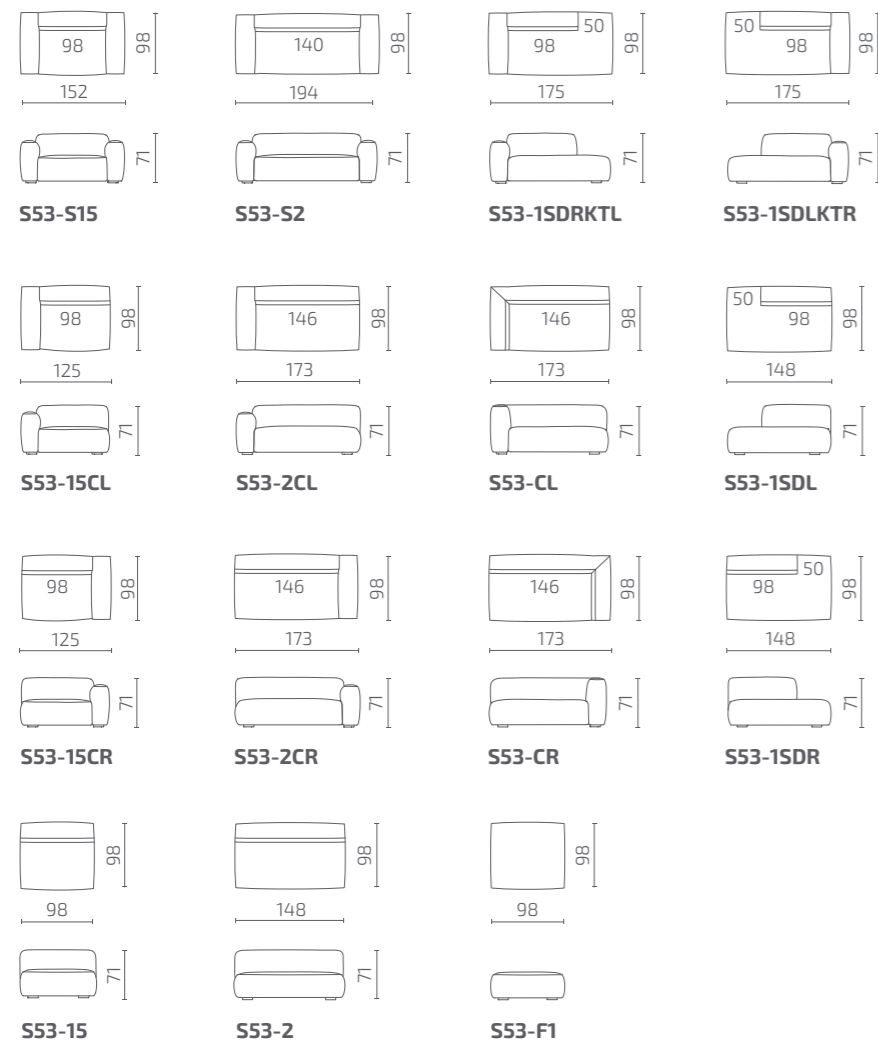

All dimensions provided in centimetres.

### SAMPLE COMBINATIONS

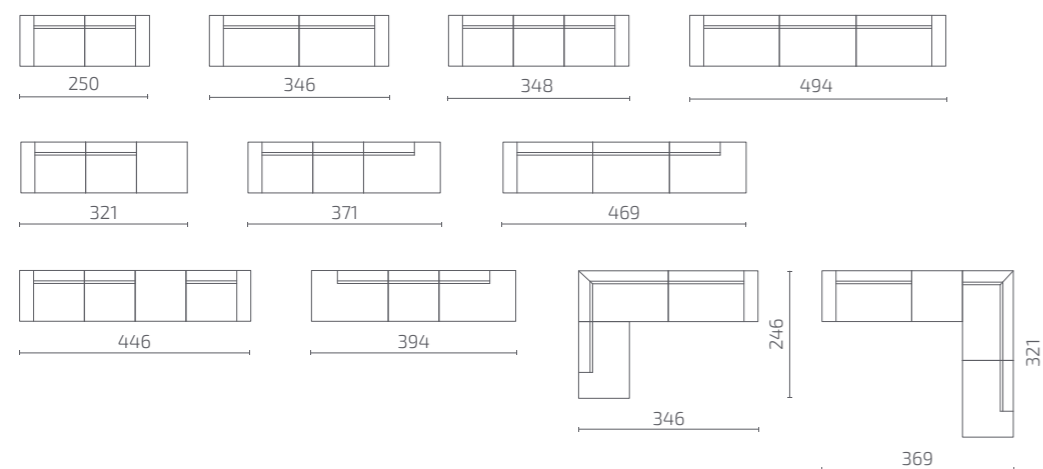

### Pillows

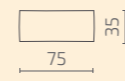

#### S53-P1

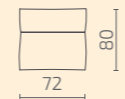

#### S53-P2

## PRICE LIST

Currency: € (VAT excl.)

PRODUCT NAME	CODE	COM/PWF*	FABRIC CONS.	FABRIC 1	FABRIC 2	FABRIC 3	FABRIC 4	FABRIC 5
DON loveseat 1.5-Seat	S53-S15	1984	7,6	2053	2287	2542	2883	3223
DON sofa 2-Seat	S53-S2	2336	9,0	2417	2694	2996	3400	3803
DON separate module with armrest (left)	S53-1SDRKTL	2096	6,4	2154	2351	2566	2853	3139
DON separate module with armrest (right)	S53-1SDLKTR	2096	6,4	2154	2351	2566	2853	3139
DON module 1.5-Seat with armrest (left)	S53-15CL	1569	5,9	1622	1803	2002	2266	2530
DON corner 1.5-Seat with armrest (right)	S53-15CR	1569	5,9	1622	1803	2002	2266	2530
DON module 2-Seat with armrest (left)	S53-2CL	1917	7,3	1983	2208	2453	2780	3107
DON module 2-Seat with armrest (right)	S53-2CR	1917	7,3	1983	2208	2453	2780	3107
DON corner module (left)	S53-CL	1887	7,2	1952	2174	2416	2738	3061
DON corner module (right)	S53-CR	1887	7,2	1952	2174	2416	2738	3061
DON extended seat module (left)	S53-1SDL	1674	4,8	1717	1865	2026	2241	2456
DON extended seat module (right)	S53-1SDR	1674	4,8	1717	1865	2026	2241	2456
DON module 1.5-Seat	S53-15	1118	3,7	1151	1265	1390	1555	1721
DON module 2-Seat	S53-2	1478	5,1	1524	1681	1852	2081	2309
DON footrest 1	S53-F1	912	3,2	941	1040	1147	1291	1434
DON pillow small	S53-P1	84	1,0	93	124	157	202	247
DON pillow large	S53-P2	160	1,6	174	223	277	349	420

\* Customer's Own Material / Price Without Fabric



1.5-Seat with armrest (left) / 1.5-Seat



1.5-Seat with armrest (left) / 1.5-Seat / Footrest



1.5-Seat with armrest (left) / Extended seat module (right)



Separate module with armrest (left)



2-Seat with armrest (left) / 2-Seat with armrest (right)



2-Seat / Corner module (left)



Extended seat module (left) / Corner module (left) / Extended seat module (right)

# Frankie

Available at  

## Work sofa

Design: Argo Tamm

The slender and versatile Frankie embodies Intuit's agile ethos. With options of a sofa, armchair, and extended bench your imagination is the only limit. The set includes an attached table: a space for a computer, mug or magazine. Find your sweet spot with Frankie.



## PRODUCT INFORMATION

### Versions

Available in many different dimensions

### Modularity

Modules can be connected together

### Accessories

Rotating attached side table to add functionality  
 Extra pillow

### Electrical outlet

Under the seating attached to the frame

### Warranty

5 years

### Sustainability

Based on principles of the circular economy

### Test & Certification

L1 European Standard strength, durability and safety certificate



## STANDARD MATERIALS

### Frame

Metal, solid wood and plywood

### Seat & backrest

Durable HR foam; fire retardant HR foam on request

### Legs

Powder-coated metal; anti-slip soles

### Table

Matt high-pressure laminate, or mass-colored wood fibreboard top with matt powder-coated metal frame

### Pillow

Feather filling

### Fabric upholstery

The cover fabric is not removable  
 Choose any fabric from **Intuit Standard Fabric Collection**

### Additional information

As part of after-sales service we offer the change of cover fabric and all other components if needed

Pipedrive office in Tallinn, Estonia



Collaboration Zone



Concentration Zone

Divide your space organically

Create focus and seclusion

Encourage rest

Host your own private meeting

## FINISHING OPTIONS

### Legs

#### Powder-coated metal

Jet Black RAL 9005



### Tabletop

#### High-pressure laminate, plywood edge

Black



#### Mass-colored wood fibreboard

Grey



Black



### Table frame

#### Powder-coated metal

Jet Black RAL 9005



Other finishing options available on request.



## ELECTRICAL OUTLET

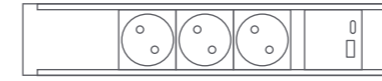

3x 220V + USB A & C

### Bachmann Power Strip

Color: Black Matt

Available options DK, EU, FR, UK

Other electrical outlet combinations available on request.



## SAMPLE COMBINATIONS



1-Seat with 2 side wall



1-Seat with 3 side wall



2-Seat with double opposite 2 side walls



2-Seat with double 2 side walls



2-Seat with double 2/3 side walls



2-Seat with double 3 side walls



Frankie side table

## DIMENSIONS

### Modules



### Table

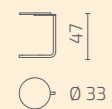

**S107-T330**

### Pillow

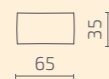

**S107-DP**

All dimensions provided in centimetres.

## PRICE LIST

Currency: € (VAT excl.)

PRODUCT NAME	CODE	COM/PWF*	FABRIC CONS.	FABRIC 1	FABRIC 2	FABRIC 3	FABRIC 4	FABRIC 5
FRANKIE module 1-Seat	<b>S107-F1</b>	669	1,7	685	737	794	870	946
FRANKIE module 2-Seat	<b>S107-F2</b>	981	2,3	1002	1073	1150	1253	1356
FRANKIE module 1-Seat with 2 side walls (left)	<b>S107-2WLS1</b>	1618	5,8	1670	1848	2043	2303	2563
FRANKIE module 1-Seat with 2 side walls (right)	<b>S107-2WRS1</b>	1618	5,8	1670	1848	2043	2303	2563
FRANKIE module 1-Seat with 3 side walls (left)	<b>S107-3WLS1</b>	1864	6,5	1923	2123	2341	2632	2924
FRANKIE module 1-Seat with 3 side walls (right)	<b>S107-3WRS1</b>	1864	6,5	1923	2123	2341	2632	2924
FRANKIE module 2-Seat with 2 side walls (left)	<b>S107-2WLS2</b>	1921	6,4	1979	2176	2391	2678	2965
FRANKIE module 2-Seat with 2 side walls (right)	<b>S107-2WRS2</b>	1921	6,4	1979	2176	2391	2678	2965
FRANKIE module 2-Seat with 3 side walls (left)	<b>S107-3WLS2</b>	2230	7,1	2293	2512	2751	3069	3387
FRANKIE module 2-Seat with 3 side walls (right)	<b>S107-3WRS2</b>	2230	7,1	2293	2512	2751	3069	3387
FRANKIE module 2-Seat with double 2 side walls	<b>S107-2WL2WRS2</b>	2859	10,5	2953	3276	3629	4100	4570
FRANKIE module 2-Seat with double opposite 2 side walls (left)	<b>S107-2WL2WLS2</b>	2859	10,5	2953	3276	3629	4100	4570
FRANKIE module 2-Seat with double opposite 2 side walls (right)	<b>S107-2WR2WRS2</b>	2859	10,5	2953	3276	3629	4100	4570
FRANKIE module 2-Seat with double 3 side walls	<b>S107-3WL3WRS2</b>	3497	11,9	3604	3971	4371	4904	5437
FRANKIE module 2-Seat with double opposite 3 side walls (left)	<b>S107-3WL3WLS2</b>	3497	11,9	3604	3971	4371	4904	5437
FRANKIE module 2-Seat with double opposite 3 side walls (right)	<b>S107-3WR3WRS2</b>	3497	11,9	3604	3971	4371	4904	5437
FRANKIE module 2-Seat with double 2/3 side walls (left)	<b>S107-3WL2WRS2</b>	3164	11,2	3265	3610	3986	4488	4990
FRANKIE module 2-Seat with double 2/3 side walls (right)	<b>S107-2WL3WRS2</b>	3164	11,2	3265	3610	3986	4488	4990
FRANKIE module 2-Seat with double opposite 2/3 side walls (left)	<b>S107-2WL3WLS2</b>	3164	11,2	3265	3610	3986	4488	4990
FRANKIE module 2-Seat with double opposite 2/3 side walls (right)	<b>S107-2WR3WRS2</b>	3164	11,2	3265	3610	3986	4488	4990
FRANKIE extra pillow**	<b>S107-DP</b>	74	0,9	82	110	140	180	221

TABLE	CODE	PRICE
FRANKIE side table (Ø 33 cm)	<b>S107-T330</b>	440

ELECTRICAL OUTLET	CODE	PRICE
Bachmann Power Strip 3x 220V + USB A & C	<b>S114-EL1</b>	353

\* Customer's Own Material / Price Without Fabric  
 \*\* Backrest pillows, corresponding to the number of module seats and upholstered in the same price category material as the seats, are included in the price.

PRICE LIST

Currency: € (VAT excl.)

PRODUCT NAME	CODE	COM/PWF*	FABRIC CONS.	FABRIC 1	FABRIC 2	FABRIC 3	FABRIC 4	FABRIC 5
<b>Multiple fabrics**</b>								
FRANKIE module 1-Seat	<b>S107-F1</b>	675	2,0	693	755	822	911	1001
FRANKIE module 2-Seat	<b>S107-F2</b>	1025	4,6	1066	1208	1363	1569	1775
FRANKIE module 1-Seat with 2 side walls (left)	<b>S107-2WLS1</b>	1625	6,2	1681	1872	2080	2358	2636
FRANKIE module 1-Seat with 2 side walls (right)	<b>S107-2WRS1</b>	1625	6,2	1681	1872	2080	2358	2636
FRANKIE module 1-Seat with 3 side walls (left)	<b>S107-3WLS1</b>	1876	7,1	1939	2158	2397	2715	3033
FRANKIE module 1-Seat with 3 side walls (right)	<b>S107-3WRS1</b>	1876	7,1	1939	2158	2397	2715	3033
FRANKIE module 2-Seat with 2 side walls (left)	<b>S107-2WLS2</b>	1967	8,8	2046	2317	2613	3007	3401
FRANKIE module 2-Seat with 2 side walls (right)	<b>S107-2WRS2</b>	1967	8,8	2046	2317	2613	3007	3401
FRANKIE module 2-Seat with 3 side walls (left)	<b>S107-3WLS2</b>	2279	9,7	2366	2665	2991	3425	3860
FRANKIE module 2-Seat with 3 side walls (right)	<b>S107-3WRS2</b>	2279	9,7	2366	2665	2991	3425	3860
FRANKIE module 2-Seat with double 2 side walls	<b>S107-2WL2WRS2</b>	2906	13,0	3023	3423	3860	4443	5025
FRANKIE module 2-Seat with double opposite 2 side walls (left)	<b>S107-2WL2WLS2</b>	2906	13,0	3023	3423	3860	4443	5025
FRANKIE module 2-Seat with double opposite 2 side walls (right)	<b>S107-2WR2WRS2</b>	2906	13,0	3023	3423	3860	4443	5025
FRANKIE module 2-Seat with double 3 side walls	<b>S107-3WL3WRS2</b>	3552	14,8	3686	4141	4639	5302	5965
FRANKIE module 2-Seat with double opposite 3 side walls (left)	<b>S107-3WL3WLS2</b>	3552	14,8	3686	4141	4639	5302	5965
FRANKIE module 2-Seat with double opposite 3 side walls (right)	<b>S107-3WR3WRS2</b>	3552	14,8	3686	4141	4639	5302	5965
FRANKIE module 2-Seat with double 2/3 side walls (left)	<b>S107-3WL2WRS2</b>	3164	11,2	3265	3610	3986	4488	4990
FRANKIE module 2-Seat with double 2/3 side walls (right)	<b>S107-2WL3WRS2</b>	3164	11,2	3265	3610	3986	4488	4990
FRANKIE module 2-Seat with double opposite 2/3 side walls (left)	<b>S107-2WL3WLS2</b>	3164	11,2	3265	3610	3986	4488	4990
FRANKIE module 2-Seat with double opposite 2/3 side walls (right)	<b>S107-2WR3WRS2</b>	3164	11,2	3265	3610	3986	4488	4990

\* Customer's Own Material / Price Without Fabric

\*\* Backrest pillows, corresponding to the number of module seats and upholstered in the same price category material as the seats, are included in the price.

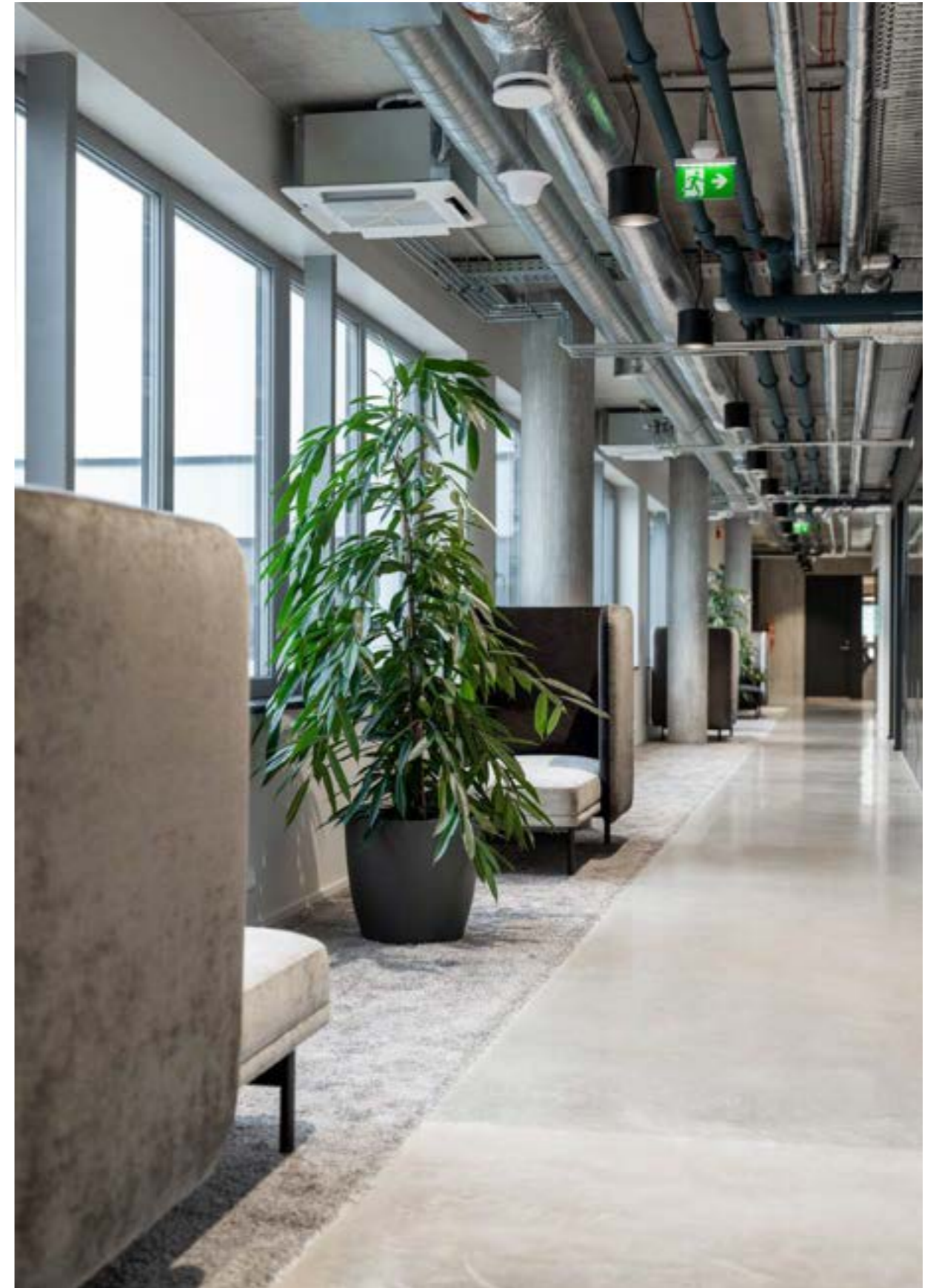

Net group office in Tallinn, Estonia. Photo: Tõnu Runnel

# Harles

## Soft office sofa

Design: Silver-Harles Haljandi

An office that feels like home creates a sense of warmth and belonging, where everyone feels welcomed and cared for. With its flowing form, Harles conveys this message in an effortless and chic way, with a touch of luxury.

The strength of the Harles sofa lies in its softness. Comfy seat cushions, filled with triple-layer foam, maintain their shape beautifully and make sitting a real pleasure. Designed with curves on all sides, Harles brings a sense of cosiness to any space, while its stylish high legs add an air of elegance. Opt for a seat module with a striking diagonal shape, and the character of Harles truly shines.



Welcome Zone



Social Zone



Collaboration Zone



Concentration Zone

Make waiting more comfortable

Feel homely and cosy

A nice place to chat

## PRODUCT INFORMATION

### Versions

Available in many different sizes

### Warranty

5 years

### Sustainability

Based on principles of the circular economy

### Certification



## STANDARD MATERIALS

### Frame

Solid wood and plywood, zigzag springs

### Seat and backrest

Durable HR foam; fire retardant HR foam on request

### Legs

Solid oak / Powder-coated metal

### Fabric upholstery

The cover fabric is removable

Choose any fabric from Intuit **Standard Fabric Collection**

### Additional information

As part of after-sales service we offer the change of cover fabric and all other components if needed



## LEGS



Solid oak legs, stained and varnished;  
anti-slip soles



Matt powder-coated metal legs;  
anti-slip soles

### **Solid oak**

Whitened



Natural



Wenge

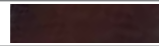

Black



### **Powder-coated metal**

Jet Black RAL 9005



Other finishing options available on request.



## DIMENSIONS

Sofa height: 93 cm / Seat depth: 65 cm / Seat height: 43 cm

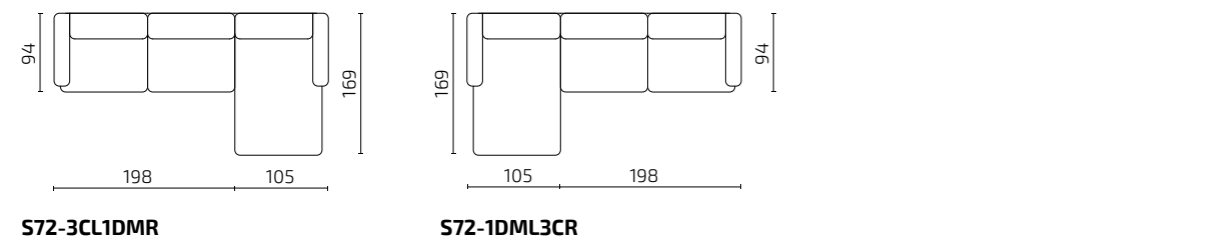
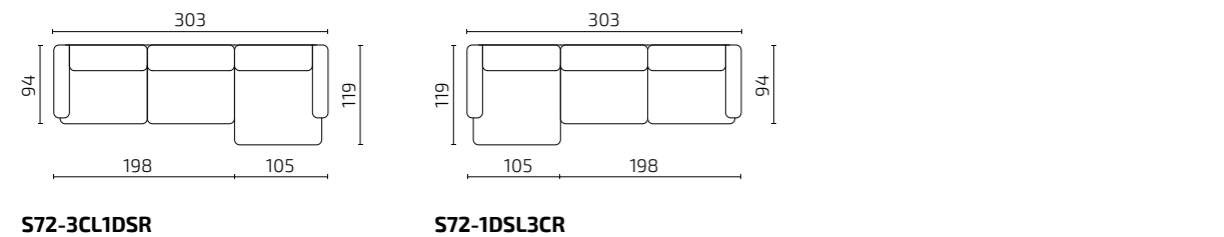
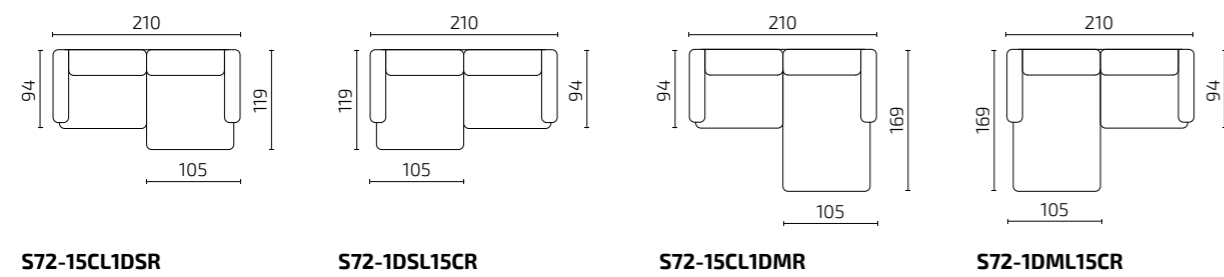
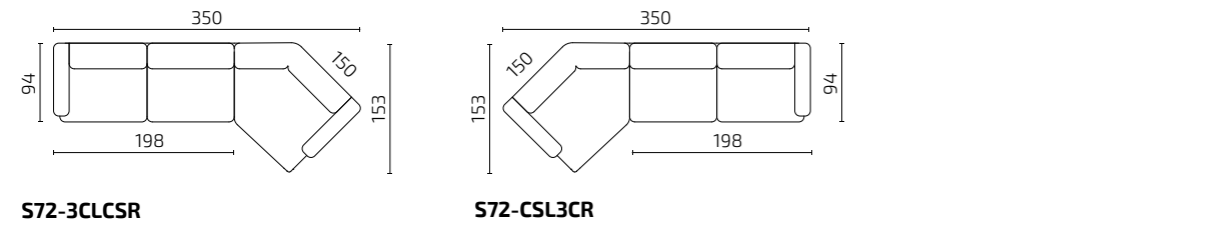
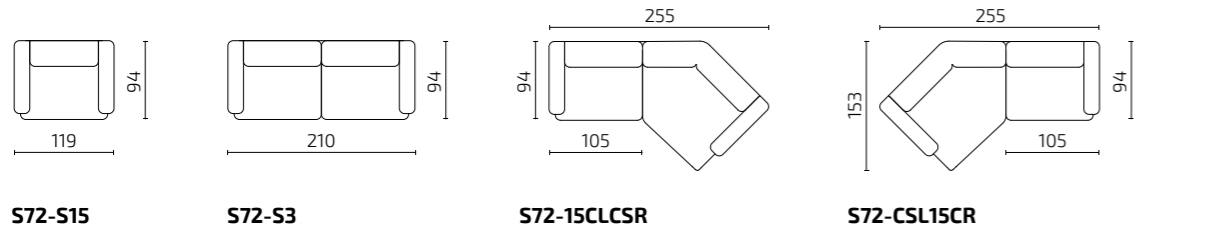

All dimensions provided in centimetres.

## PRICE LIST

Currency: € (VAT excl.)

PRODUCT NAME	CODE	COM/PWF*	FABRIC CONS.	FABRIC 1	FABRIC 2	FABRIC 3	FABRIC 4	FABRIC 5
HARLES loveseat 1.5-Seat	<b>S72-S15</b>	1603	6,1	1657	1845	2050	2324	2597
HARLES sofa 3-Seat	<b>S72-S3</b>	2607	11,8	2714	3077	3473	4002	4531
HARLES module 1.5-Seat with corner module (right)	<b>S72-15CLCSR</b>	3620	15	3755	4217	4721	5393	6065
HARLES module 1.5-Seat with corner module (left)	<b>S72-CSL15CR</b>	3620	15	3755	4217	4721	5393	6065
HARLES module 3-Seat with corner module (right)	<b>S72-3CLCSR</b>	4455	19,8	4633	5243	5908	6795	7682
HARLES module 3-Seat with corner module (left)	<b>S72-CSL3CR</b>	4455	19,8	4633	5243	5908	6795	7682
HARLES module 1.5-Seat with small chaise longue (right)	<b>S72-15CL1DSR</b>	3141	12,6	3254	3642	4065	4630	5194
HARLES module 1.5-Seat with small chaise longue (left)	<b>S72-1DSL15CR</b>	3141	12,6	3254	3642	4065	4630	5194
HARLES module 1.5-Seat with extended chaise longue (right)	<b>S72-15CL1DMR</b>	3344	14,8	3478	3933	4431	5094	5757
HARLES module 1.5-Seat with extended chaise longue (left)	<b>S72-1DML15CR</b>	3344	14,8	3478	3933	4431	5094	5757
HARLES module 3-Seat with small chaise longue (right)	<b>S72-3CL1DSR</b>	3976	17,4	4132	4668	5253	6032	6812
HARLES module 3-Seat with small chaise longue (left)	<b>S72-1DSL3CR</b>	3976	17,4	4132	4668	5253	6032	6812
HARLES module 3-Seat with extended chaise longue (right)	<b>S72-3CL1DMR</b>	4180	19,6	4356	4960	5618	6496	7374
HARLES module 3-Seat with extended chaise longue (left)	<b>S72-1DML3CR</b>	4180	19,6	4356	4960	5618	6496	7374

\* Customer's Own Material / Price Without Fabric

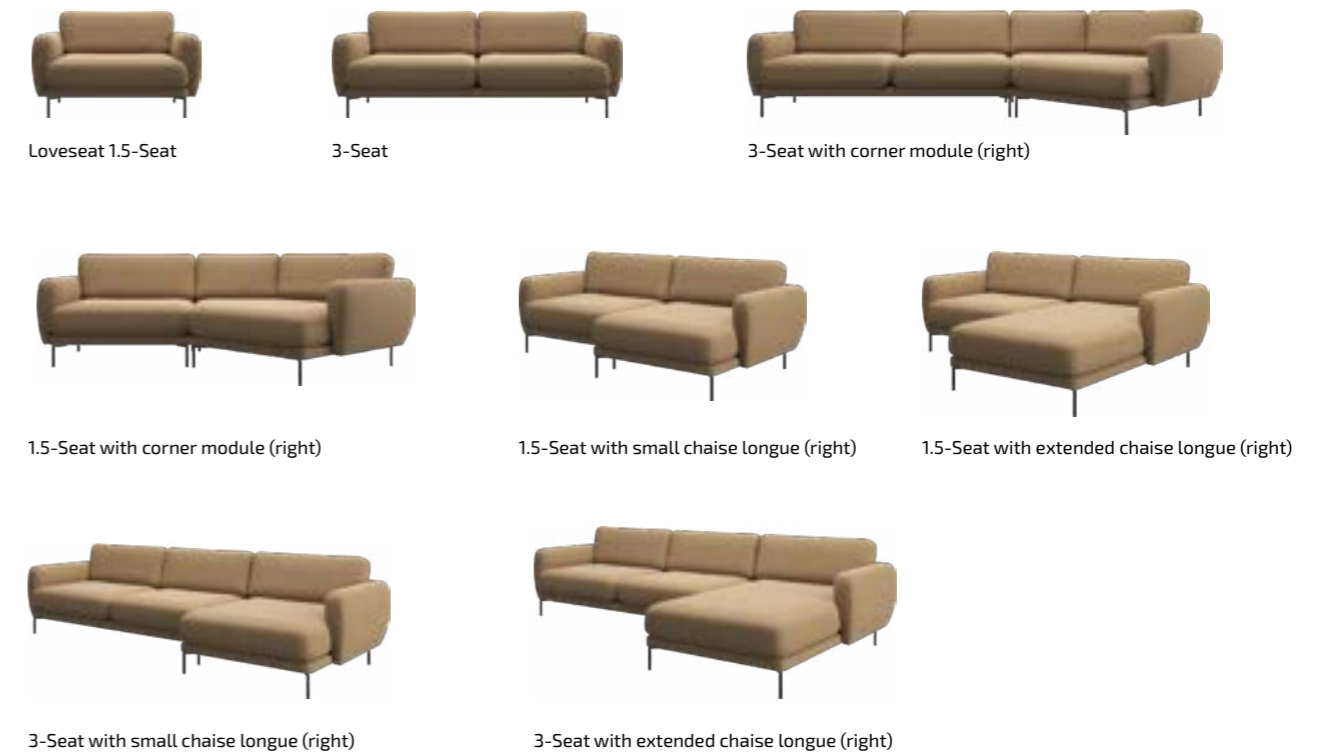

# Hide

## Mobile office armchair

Design: Pent Talvet, Iseasi

A cozy nest in the middle of the office. Some tasks demand a different level of immersion. Some require that you get up from your desk, grab your laptop and slip into a more comfortable corner to allow your thoughts room to roam. The Hide has been specifically designed to be a soft nest to which office nomads can retreat.

Hide's mobility allows for easy repositioning to suit your needs, whether that means facing an inspiring view from a window or turning away from the noisy office crowd.



Concentration Zone

Create a homey atmosphere

Make for a perfect hideaway

## PRODUCT INFORMATION

### Versions

Available in 2 sizes

### Legs

360° rotating and lockable castors

### Warranty

5 years

### Sustainability

Based on principles of the circular economy

### Certification



## STANDARD MATERIALS

### Frame

Plywood and metal

### Seat & backrest

Durable HR foam; fire retardant HR foam on request

### Legs

Powder-coated metal

### Table and shelving

Veneered oak MDF board with solid wood edge

### Fabric upholstery

The cover fabric is not removable

Choose any fabric from **Intuit Standard Fabric Collection**

### Additional information

As part of after-sales service we offer the change of cover fabric and all other components if needed



## FINISHING OPTIONS

### Tabletop and shelving

#### Veneered MDF board

Natural oak



Other finishing options available on request.

### Legs/Frame

#### Powder-coated metal

Jet Black RAL 9005



360° rotating attached table



## DIMENSIONS

Seat height: 40 cm



All dimensions provided in centimetres.

## PRICE LIST

Currency: € (VAT excl.)

PRODUCT NAME	CODE	COM/ PWF*	FABRIC CONS.	FABRIC 1	FABRIC 2	FABRIC 3	FABRIC 4	FABRIC 5
Hide armchair with side table 360° rotating (left)	<b>S125-1L + S125-T2</b>	2171	7,1	2235	2454	2692	3010	3328
Hide armchair with side table 360° rotating (right)	<b>S125-1R + S125-T2</b>	2171	7,1	2235	2454	2692	3010	3328
HIDE armchair with shelved side table (left)	<b>S125-15L</b>	2530	7,6	2599	2833	3088	3429	3769
HIDE armchair with shelved side table (right)	<b>S125-15R</b>	2530	7,6	2599	2833	3088	3429	3769

\* Customer's Own Material / Price Without Fabric

# Hubert & Hubert Mini

Available at  

## High and low chair for meeting tables

Design: Iseasi

A chair that lets you brainstorm in style. The sleek frame and raised seat of the Hubert help to support ergonomic posture effortlessly, while the 360° swivel base lets you rotate and rock while ideating – great for productive and dynamic team meetings.

Simple to maneuver, these chairs help you create a welcoming and agile collaboration space at a moment's notice.



Collaboration Zone

Bring heads together at a moment's notice

Encourage active problem-solving

Make your office flexible

## PRODUCT INFORMATION

### Versions

Available in bar stool and regular seat height

### Rocking base

Available with a rocking base and 360° rotating & tilting base

### Warranty

5 years

### Sustainability

Based on principles of the circular economy

### Certification



## STANDARD MATERIALS

### Frame

Plywood

### Seat & backrest

Durable HR foam; fire retardant HR foam on request

### Legs

Rocking base: oak

360° rotating & tilting base: plastic POM, black

### Fabric upholstery

The cover fabric is removable

Choose any fabric from **Intuit Standard Fabric Collection**

### Additional information

As part of after-sales service we offer the change of cover fabric and all other components if needed

SK ID Solutions office in Tallinn, Estonia. Photo: Märt Lillesiim





Ev. Hochschule in Freiburg, Germany



## DIMENSIONS

### Rocking base

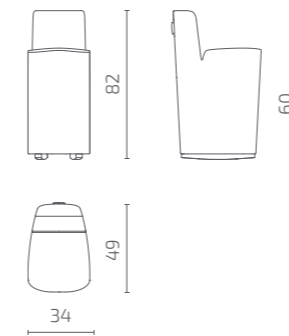

**S109-FL1**

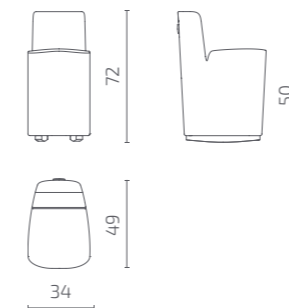

**S109-MFL1**

### 360° rotating & tilting base

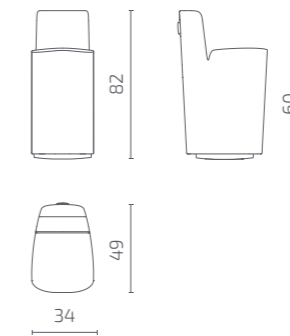

**S109-FL2**

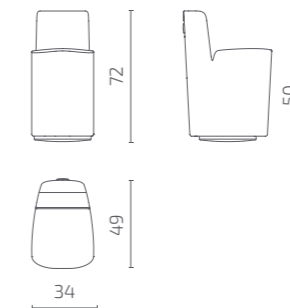

**S109-MFL2**

Seat depth: 36 cm

All dimensions provided in centimetres.

## PRICE LIST

Currency: € (VAT excl.)

PRODUCT NAME	CODE	COM/ PWF*	FABRIC CONS.	FABRIC 1	FABRIC 2	FABRIC 3	FABRIC 4	FABRIC 5
HUBERT high chair with rocking base	<b>S109-FL1</b>	588	1,8	604	660	720	801	882
HUBERT high chair with 360° rotating and tilting base	<b>S109-FL2</b>	723	1,8	739	794	855	935	1016
HUBERT low chair with rocking base	<b>S109-MFL1</b>	569	1,8	585	641	701	782	862
HUBERT low chair with 360° rotating and tilting base	<b>S109-MFL2</b>	699	1,8	715	770	831	911	992

\* Customer's Own Material / Price Without Fabric

The chic design also comes in miniature. **Hubert Mini** has all the benefits of ergonomic design, manoeuvrability, and style, whilst being just the right size for regular meeting tables.



# Intro

## Lounge chair

Design: Argo Tamm

Not every office can cater for sprawling sofas and ping pong tables. But don't despair! If you're looking to create a flexible area for building community and encouraging relaxation, then we have what you need.

Compact, minimalist, oh so comfortable, Intro is easy to sink into with a cup of steaming coffee. And with its streamlined proportions you have an elegant solution to your space constraints.



Welcome Zone



Social Zone

Make your visitors feel welcome

Take a welcome break from your desk

Make connections with colleagues

## PRODUCT INFORMATION

**Leg**  
360° swivel base: metal leg and wood base

**Warranty**  
5 years

**Sustainability**  
Based on principles of the circular economy

### Certification



## STANDARD MATERIALS

**Frame**  
Metal

**Leg**  
Powder-coated metal leg and wood base

**Seat & backrest**  
High resiliency moulded PU foam

**Fabric upholstery**  
The cover fabric is not removable  
Choose any fabric from **Intuit Standard Fabric Collection**

**Additional information**  
As part of after-sales service we offer the change of cover fabric and all other components if needed

## FINISHING OPTIONS

### Leg

#### Solid oak

Natural	
Wenge	
Black	

#### Powder-coated metal

Jet Black RAL 9005	
Stone Grey RAL 7030	
Traffic White RAL 9016	

Other finishing options available on request.

## DIMENSIONS

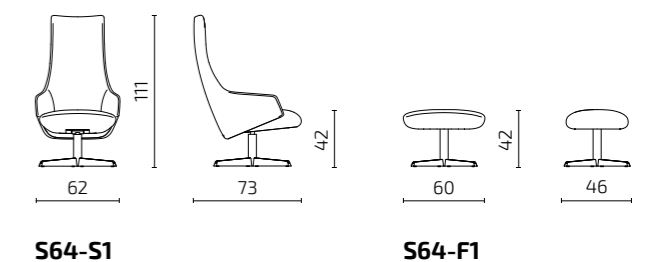

All dimensions provided in centimetres.

## PRICE LIST

Currency: € (VAT excl.)

PRODUCT NAME	CODE	COM/PWF*	FABRIC CONS.	FABRIC 1	FABRIC 2	FABRIC 3	FABRIC 4	FABRIC 5
INTRO armchair	S64-S1	1356	2,1	1375	1440	1511	1605	1699
INTRO footrest	S64-F1	691	1,0	700	731	765	810	854

\* Customer's Own Material / Price Without Fabric

# Kimi

## Japandi-inspired, environmentally conscious sofa

Design: Argo Tamm

Inspired by Japandi style, Kimi brings balance, calm and conscious simplicity into the workplace. Its solid wood frame has a restrained, architectural presence, while adding warmth and natural character to the interior.

Thanks to its modular structure, Kimi can be configured into sofa compositions that suit a variety of spaces — from reception areas and lounges to quieter meeting and conversation zones. A practical movable armrest/table is available as an accessory: one side functions as a comfortable support to lean against, while the other provides a solid surface for a coffee cup, laptop or notebook. Decorative cushions can also be added to enhance back support and overall comfort.



## PRODUCT INFORMATION

### Versions

Available in many different sizes

### Modularity

Modules can be connected together

### Accessories

Movable armrest / side table: double-sided, one side functions as a tabletop, the other as a padded armrest  
Decorative cushion: adds extra back comfort.

### Warranty

5 years

### Sustainability

Designed according to circular economy principles.  
All sofa components are easily replaceable, supporting long product life and responsible use

### Certification



## STANDARD MATERIALS

### Leg frame

Solid ash wood with long lamella profile  
Finishes: natural or oak stain (matte lacquer)

### Seat and back cushions

Back cushion: plywood frame with HS foam;  
Seat cushion: HR foam with bent plywood slats underneath

### Fabric upholstery

The covers are fully removable. 100% cotton base fabric  
Choose any fabric from Intuit **Standard Fabric Collection**

### Additional information

As part of our after-sales service, we offer replacement of upholstery and all other components when needed



Welcome Zone



Social Zone

Help create a balanced, low-stress environment

Offer comfortable seating for relaxed conversations

Support sustainable and responsible interior design

## FINISHING OPTIONS

### Leg frame

#### Solid ash

Natural

Oak stain



Other finishing options available on request.



## One of Intuit's most sustainable sofa solutions



Kimi has been designed in line with **circular economy principles**. Instead of a traditional boxed construction, its frame is based on monomaterials, making the sofa fully recyclable. All upholstery covers are completely removable, allowing for easy maintenance and replacement — extending the product's lifespan and supporting long-term, responsible use.

## DIMENSIONS

### Individual modules

Seat depth: 74 cm

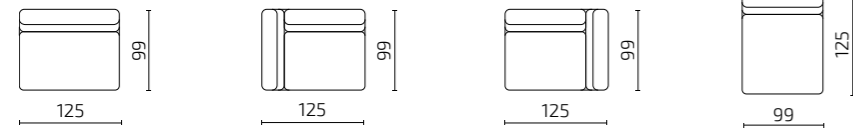
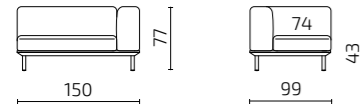

**S77-1**

**S77-1CL**

**S77-1CR**

**S77-1D**

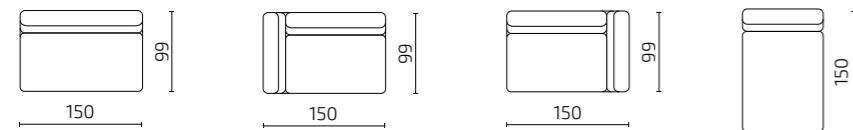

**S77-2**

**S77-2CL**

**S77-2CR**

**S77-2D**

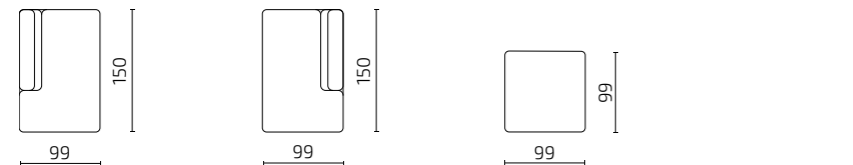

**S77-2SDL**

**S77-2SDR**

**S77-1F**

### Modules to combine

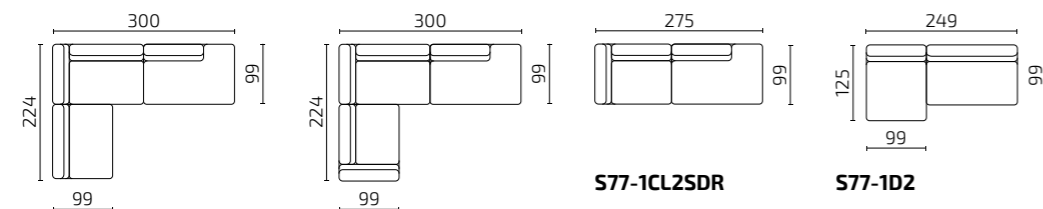

**S77-12CL2SDR**

**S77-1CL2CL2SDR**

**S77-1CL2SDR**

**S77-1D2**

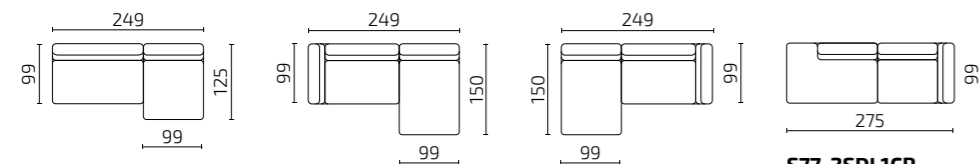

**S77-21D**

**S77-2CL2D**

**S77-2D2CR**

**S77-2SDL1CR**

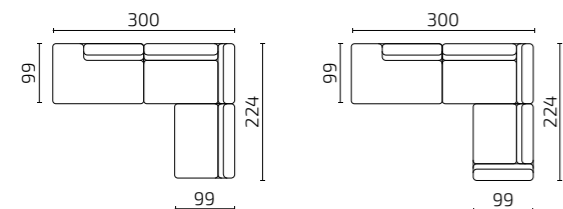

**S77-2SDL2CR1**

**S77-2SDL2CR1CR**

All dimensions provided in centimetres.

### Movable armrest/ side table

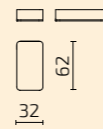

**S77-KT1**

### Decorative cushion

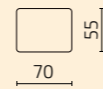

**S77-P1**

## PRICE LIST

Currency: € (VAT excl.)

PRODUCT NAME	CODE	COM/PWF*	FABRIC CONS.	FABRIC 1	FABRIC 2	FABRIC 3	FABRIC 4	FABRIC 5
KIMI module 1-Seat	<b>S77-1</b>	1547	4,8	1625	1773	1935	2150	2365
KIMI module 1-Seat with armrest (left)	<b>S77-1CL</b>	1692	5,6	1793	1965	2153	2404	2655
KIMI module 1-Seat with armrest (right)	<b>S77-1CR</b>	1692	5,6	1793	1965	2153	2404	2655
KIMI module 1-Seat with small chaise longue	<b>S77-1D</b>	1527	5,1	1614	1771	1942	2171	2399
KIMI module 2-Seat	<b>S77-2</b>	1784	5,6	1885	2057	2245	2496	2747
KIMI module 2-Seat with armrest (left)	<b>S77-2CL</b>	2022	5,8	2128	2307	2502	2762	3022
KIMI module 2-Seat with armrest (right)	<b>S77-2CR</b>	2022	5,8	2128	2307	2502	2762	3022
KIMI module 1-Seat with extended chaise longue	<b>S77-2D</b>	1650	5,1	1737	1894	2065	2294	2522
KIMI module 2-Seat with extended seat (left)	<b>S77-2SDL</b>	1752	5,4	1847	2013	2195	2437	2679
KIMI module 2-Seat with extended seat (right)	<b>S77-2SDR</b>	1752	5,4	1847	2013	2195	2437	2679
KIMI pouf	<b>S77-1F</b>	1113	3,5	1155	1263	1380	1537	1694
KIMI armrest / side table	<b>S77-KT1</b>	454	0,7	473	490	497	529	560
KIMI cushion	<b>S77-P1</b>	126	0,8	148	160	176	212	248
KIMI combination 1-Seat + 2-Seat with armrest (left) + 2-Seat with extended seat (right)	<b>S77-12CL2SDR</b>	5209	16	5601	6094	6631	7348	8065
KIMI combination 1-Seat with armrest (left) + 2-Seat with armrest (left) + 2-Seat with extended seat (right)	<b>S77-1CL2CL2SDR</b>	5354	11,2	5611	5956	6332	6834	7336
KIMI combination 1-Seat with armrest + 2-Seat with extended seat (right)	<b>S77-1CL2SDR</b>	3387	11	3639	3978	4348	4841	5333
KIMI combination 1-Seat with small chaise longue + 2-Seat	<b>S77-1D2</b>	3255	10,7	3499	3828	4188	4667	5146
KIMI combination 2-Seat + 1-Seat with small chaise longue	<b>S77-21D</b>	3255	10,7	3499	3828	4188	4667	5146
KIMI combination 2-Seat with armrest (left) + 1-Seat with extended chaise longue	<b>S77-2CL2D</b>	3616	10,9	3865	4201	4567	5056	5544
KIMI combination 2-Seat with extended chaise longue + 2-Seat with armrest (right)	<b>S77-2D2CR</b>	3616	10,9	3865	4201	4567	5056	5544
KIMI combination 2-Seat with extended seat (left) + 1-Seat with armrest (right)	<b>S77-2SDL1CR</b>	3387	11	3639	3978	4348	4841	5333
KIMI combination 2-Seat with extended seat (Left) + 2-Seat with armrest (right) + 1-Seat	<b>S77-2SDL2CR1</b>	5209	16	5601	6094	6631	7348	8065
KIMI combination 2-Seat with extended seat (left) + 2-Seat armrest (right) + 1-Seat with armrest (right)	<b>S77-2SDL2CR1CR</b>	5354	16,8	5768	6285	6850	7603	8355

\* Customer's Own Material / Price Without Fabric

# Lilja

## Work sofa

Design: Samuli Naamanka

Transforming public spaces with Nordic elegance. Created in collaboration with Finnish designer Samuli Naamanka, Lilja is a tribute to the harmony and timelessness of Nordic design. Warm and friendly solid wood and elegant lines make up a pleasing piece of furniture that reflects the Nordic attitude to style and quality.

Lilja has flexibility at her heart, allowing you to tailor its setup to suit various spaces and personal tastes. Cherry-pick the armrest combinations. Optional backseat and armrest pillows enhance the comfort, inviting you to sink in and experience its welcoming embrace. Whether it's your office or any public area, Lilja promises to transform ordinary spaces into cozy, inviting environments. Much you value their comfort and wellbeing. Put the finishing touches to your Social Zone with this inviting sofa.



Welcome Zone



Social Zone

Foster connections among colleagues

Welcome your visitors with a touch of home

Offer a restorative retreat from the daily grind

## PRODUCT INFORMATION

### Versions

Many different modules with and without armrests

### Modularity

Modules can be connected together

### Accessories

Additional backseat and armrest pillows

### Warranty

5 years

### Sustainability

Based on principles of the circular economy

### Certification



## STANDARD MATERIALS

### Frame

Solid wood and plywood

### Seat and backrest

Durable HR foam; fire retardant HR foam on request

### Leg frames

Solid oak / Powder-coated metal

### Pillows

Feather or fibre filling

### Fabric upholstery

The cover fabric is not removable

Choose any fabric from **Intuit Standard Fabric Collection**

### Additional information

As part of after-sales service we offer the change of cover fabric and all other components if needed

Tartu University Clinic, Estonia. Photo: Märt Lillesiim



## FINISHING OPTIONS

### Leg frame

#### Solid oak

Natural



#### Powder-coated metal

Jet Black RAL 9005



Other finishing options available on request.



## SAMPLE COMBINATIONS

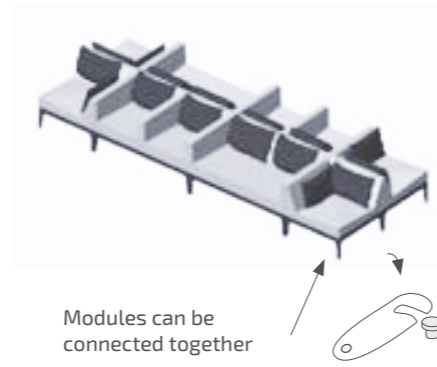
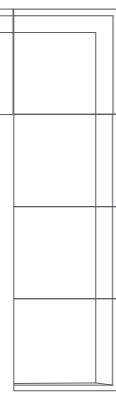
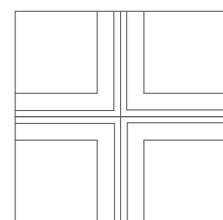
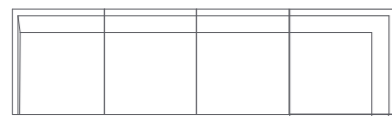
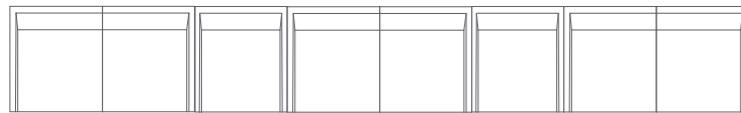
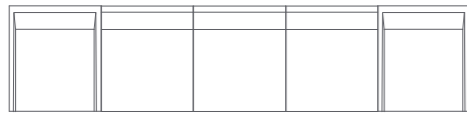
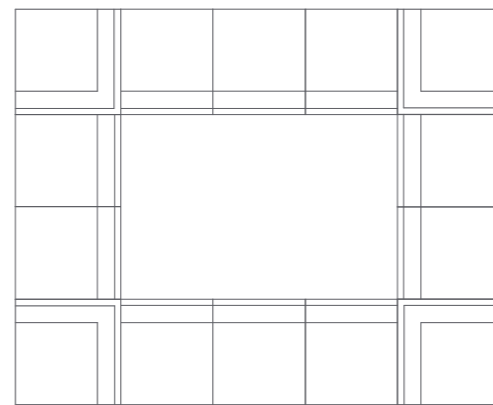
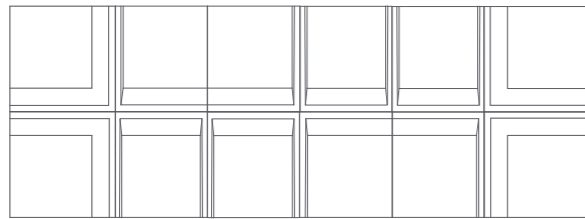

Modules can be connected together



Tartu University Clinic, Estonia. Photo: Märt Lillesiim

## DIMENSIONS

### Modules

Seat depth: 61 cm, with extra pillow 48 cm



**S102-S1**

**S102-1CL1CR**

**S102-1CL11CR**

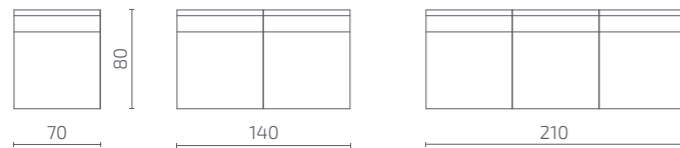

**S102-1**

**S102-11**

**S102-111**

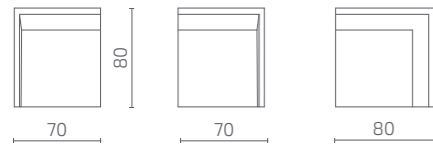

**S102-1CL**

**S102-1CR**

**S102-C**

### Oak leg frames

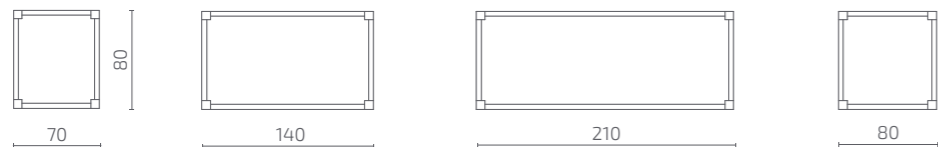

**A0803-0039**

**A0803-0040**

**A0803-0041**

**A0803-0042**

### Metal leg frames



**A0803-0050**

**A0803-0051**

**A0803-0052**

**A0803-0053**

All dimensions provided in centimetres.

### Pillows



**S102-P**  
Back pillow



**S102-KTP**  
Armrest pillow

## PRICE LIST

Currency: € (VAT excl.)

PRODUCT NAME	CODE	COM/ PWF*	FABRIC CONS.	FABRIC 1	FABRIC 2	FABRIC 3	FABRIC 4	FABRIC 5
LILJA armchair	<b>S102-S1</b>	796	2,7	820	903	994	1115	1236
LILJA sofa 2-Seat	<b>S102-1CL1CR</b>	1416	4,2	1454	1583	1725	1913	2101
LILJA sofa 3-Seat	<b>S102-1CL11CR</b>	1931	5,9	1984	2165	2364	2628	2892
LILJA module 1-Seat	<b>S102-1</b>	515	1,7	530	583	640	716	792
LILJA module 2-Seat	<b>S102-11</b>	1029	3,4	1060	1165	1279	1431	1584
LILJA module 3-Seat	<b>S102-111</b>	1544	5,1	1590	1747	1918	2147	2375
LILJA module with armrest 1-Seat (left)	<b>S102-1CL</b>	652	2,1	671	735	806	900	994
LILJA module with armrest 1-Seat (right)	<b>S102-1CR</b>	652	2,1	671	735	806	900	994
LILJA corner module	<b>S102-C</b>	708	2,1	727	792	863	957	1051
LILJA back pillow	<b>S102-P</b>	80	0,8	88	112	139	175	211
LILJA armrest pillow	<b>S102-KTP</b>	79	0,7	85	107	130	162	193

\* Customer's Own Material / Price Without Fabric

Price does not include leg frames; these must be ordered separately and matched to the seating modules.

LEG FRAMES	CODE	PRICE
LILJA oak leg frame 1-Seat	<b>A0803-0039</b>	918
LILJA oak leg frame 2-Seat	<b>A0803-0040</b>	1059
LILJA oak leg frame 3-Seat	<b>A0803-0041</b>	1189
LILJA oak leg corner frame	<b>A0803-0042</b>	988
LILJA metal leg frame 1-Seat	<b>A0803-0050</b>	484
LILJA metal leg frame 2-Seat	<b>A0803-0051</b>	519
LILJA metal leg frame 3-Seat	<b>A0803-0052</b>	590
LILJA metal leg corner frame	<b>A0803-0053</b>	484



Tartu University Clinic, Estonia. Photo: Märt Lillesiim

# Loop, Duo & Twin

## Poufs

Design: Lauri Visnapuu

We think you should be able to gather wherever inspiration strikes. Which is why we've designed our trio of playful poufs to be the ultimate in flexible seating.

Grab them by their tabs and pull them over to your colleague's desk. So that you can carry on forming your new idea, without getting a crick in your neck.



Welcome Zone



Social Zone



Collaboration Zone

Bring some playful energy

Make your seating super flexible

Gather wherever you need to

## PRODUCT INFORMATION

### Versions

Available in 3 different shapes

### Warranty

5 years

### Sustainability

Based on principles of the circular economy

### Certification



## STANDARD MATERIALS

### Frame

Solid wood and plywood

### Seat

Durable HR foam; fire retardant HR foam on request

### Fabric upholstery

The cover fabric is not removable

Choose any fabric from **Intuit Standard Fabric Collection**

### Additional information

As part of after-sales service we offer the change of cover fabric and all other components if needed

## DIMENSIONS

### Loop

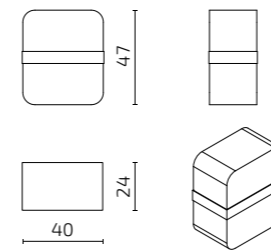

S116-F47

### Duo

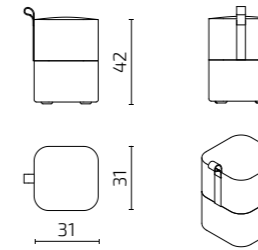

S117-F31

### Twin

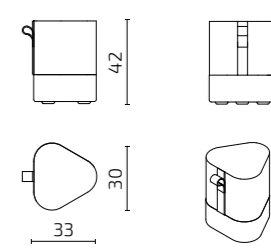

S118-F33

All dimensions provided in centimetres.

## PRICE LIST

Currency: € (VAT excl.)

PRODUCT NAME	CODE	COM / PWF*	FABRIC CONS.	FABRIC 1	FABRIC 2	FABRIC 3	FABRIC 4	FABRIC 5
LOOP pouf (40x24x47 cm)	S116-F47	263	1,7	279	331	388	464	540
DUO pouf (31x31x42 cm)	S117-F31	207	2,7	231	314	405	526	647
TWIN pouf (33x30x42 cm)	S118-F33	203	2,5	226	303	387	499	611
<b>Multiple fabrics**</b>								
LOOP pouf (40x24x47 cm)	S116-F47	250	1	259	290	323	368	413
DUO pouf (31x31x42 cm)	S117-F31	182	1,4	195	238	285	347	410
TWIN pouf (33x30x42 cm)	S118-F33	181	1,3	192	232	276	334	392

\* Customer's Own Material / Price Without Fabric

\*\* Price includes two fabrics from the same price category. For fabrics from different price categories, please contact our sales support for a price calculation.

# Meeter Modular

Available at  
**pCon**  
PLANNER

## Sofa modules

Design: Argo Tamm

Don't let your chairs distract from your chat. You can use the effortless design of the Meeter sofa modules wherever you want to bring people together. Perfect for those office reception areas and work cafes, Meeter has also found a happy home in the dining halls of catering establishments.

Renowned for its exceptional adaptability in both height and length, the Meeter sofa seamlessly integrates into any milieu. These compact sofas are engineered for endurance, effortlessly withstanding heavy usage and frequent cleaning.



Welcome Zone



Social Zone

Create compact waiting spots

Make even your smaller dining areas comfy

Optimize space with flexible seating

## PRODUCT INFORMATION

### Versions

Available in 3 different heights and in 5 standard lengths

### Modularity

Modules can be connected together

### Legs

Available with regular legs and plinth

### Accessories

Attached side table to add functionality  
Custom-made planter boxes to offer an organic touch of privacy

### Electrical outlet

Integrated electrical outlet

### Warranty

10 years

### Sustainability

Based on principles of the circular economy

### Test & Certification

- L2 European Standard strength, durability and safety certificate
- EU Ecolabel Certified



## STANDARD MATERIALS

### Frame

Solid wood and plywood

### Seat & backrest

Durable HR foam; fire retardant HR foam on request

### Legs

Solid oak / Powder-coated metal  
Plinth: Veneer / Melamine / High-pressure laminate

### Table

Mass colored wood fibreboard / high-pressure laminate top with plywood edge; powder-coated metal frame

### Planter box

Veneer / Melamine / High-pressure laminate

### Fabric upholstery

The cover material is not removable  
Choose any fabric from **Intuit Standard Fabric Collection**

### Additional information

As part of after-sales service we offer the change of cover fabric and all other components if needed

Hella Lithuania office in Kaunas, Lithuania. Photo: Norbert Tukaji



## LEGS



Solid oak legs, stained and varnished; anti-slip soles



Powder-coated metal; anti-slip soles. Available in U-shape and straight legs



Plinth  
Additional cost will apply

### Solid oak

Whitened	
Natural	
Wenge	
Black	

### Powder-coated metal

Jet Black RAL 9005	
--------------------	--

### Plinth

Natural oak veneer	
Black melamine	
Black high-pressure laminate	

Other finishing options available on request.

## PLANTER BOX

Natural oak veneer	
Black melamine	
Black high-pressure laminate	

Other finishing options available on request.



## ELECTRICAL OUTLET

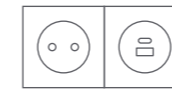

**220V + USB A & C**

Other electrical outlet combinations available on request.

**Berker Integro Flow**  
Color: Anthracite Matt

Available options DK, EU, FR, UK

## TABLE

### Tabletop

**High-pressure laminate, plywood edge**

Black	
-------	--

**Mass-colored wood fibreboard**

Grey	
Black	

### Table frame

**Powder-coated metal**

Jet Black RAL 9005	
--------------------	--

Other finishing options available on request.



Meeter side table

Totaljobs office in Portsmouth, UK. Photo: Soren Kristensen



## DIMENSIONS

### Modules

Seat depth: 45 cm / Seat height: 46 cm  
Standard lengths 62 / 80 / 100 / 120 / 150  
Custom lengths available up to 200 cm

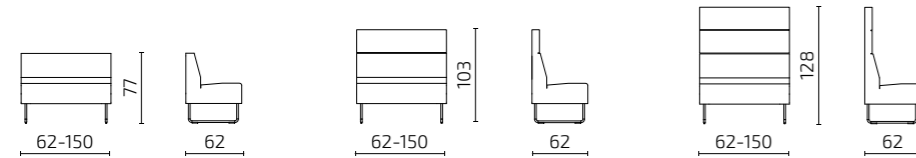

#### S108-1H162

S108-1H180  
S108-1H1100  
S108-1H1120  
S108-1H1150

#### S108-1H262

S108-1H280  
S108-1H2100  
S108-1H2120  
S108-1H2150

#### S108-1H362

S108-1H380  
S108-1H3100  
S108-1H3120  
S108-1H3150

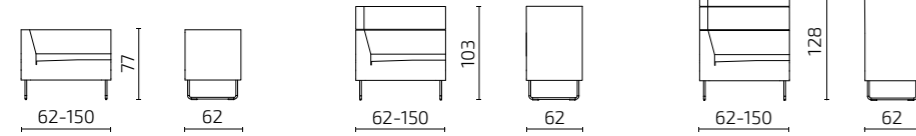

#### S108-1CLH162

S108-1CLH180  
S108-1CLH1100  
S108-1CLH1120  
S108-1CLH1150

#### S108-1CLH262

S108-1CLH280  
S108-1CLH2100  
S108-1CLH2120  
S108-1CLH2150

#### S108-1CLH362

S108-1CLH380  
S108-1CLH3100  
S108-1CLH3120  
S108-1CLH3150

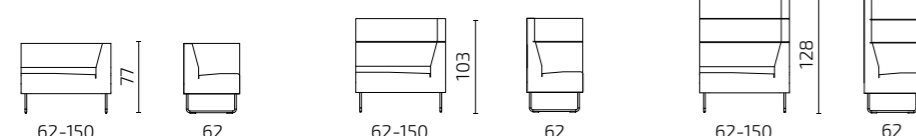

#### S108-1CRH162

S108-1CRH180  
S108-1CRH1100  
S108-1CRH1120  
S108-1CRH1150

#### S108-1CRH262

S108-1CRH280  
S108-1CRH2100  
S108-1CRH2120  
S108-1CRH2150

#### S108-1CRH362

S108-1CRH380  
S108-1CRH3100  
S108-1CRH3120  
S108-1CRH3150

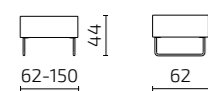

#### S108-F62

S108-F80  
S108-F100  
S108-F120  
S108-F150

All dimensions provided in centimetres.

### Table



#### S108-T1

### Planter boxes

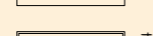
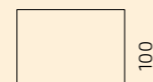
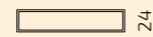
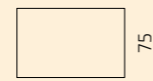

Length tailored  
to the full length  
of modular sofa

### Inner dimensions

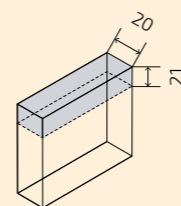

## PRICE LIST

Currency: € (VAT excl.)

PRODUCT NAME	CODE	COM/ PWF*	FABRIC CONS.	FABRIC 1	FABRIC 2	FABRIC 3	FABRIC 4	FABRIC 5
<b>Straight modules</b>								
MEETER module, height 1, length 62	<b>S108-1H162</b>	538	2,1	557	622	692	786	880
MEETER module, height 1, length 80	<b>S108-1H180</b>	641	2,5	663	740	824	936	1048
MEETER module, height 1, length 100	<b>S108-1H1100</b>	714	2,9	740	829	927	1057	1187
MEETER module, height 1, length 120	<b>S108-1H1120</b>	808	3,3	837	939	1050	1198	1346
MEETER module, height 1, length 150	<b>S108-1H1150</b>	971	3,9	1006	1126	1257	1432	1607
MEETER module, height 2, length 62	<b>S108-1H262</b>	664	2	682	744	811	901	990
MEETER module, height 2, length 80	<b>S108-1H280</b>	761	2,4	783	857	937	1045	1152
MEETER module, height 2, length 100	<b>S108-1H2100</b>	835	2,8	860	946	1040	1166	1291
MEETER module, height 2, length 120	<b>S108-1H2120</b>	943	3,2	972	1070	1178	1321	1465
MEETER module, height 2, length 150	<b>S108-1H2150</b>	1119	3,8	1153	1270	1398	1568	1738
MEETER module, height 3, length 62	<b>S108-1H362</b>	779	2,6	802	882	970	1086	1203
MEETER module, height 3, length 80	<b>S108-1H380</b>	871	3,1	899	994	1099	1237	1376
MEETER module, height 3, length 100	<b>S108-1H3100</b>	948	3,7	981	1095	1220	1386	1551
MEETER module, height 3, length 120	<b>S108-1H3120</b>	1063	4,3	1101	1234	1378	1571	1764
MEETER module, height 3, length 150	<b>S108-1H3150</b>	1231	5,2	1278	1438	1613	1846	2079
<b>Corner modules</b>								
MEETER left corner, height 1, length 62	<b>S108-1CLH162</b>	746	2,2	766	834	908	1006	1105
MEETER right corner, height 1, length 62	<b>S108-1CRH162</b>	746	2,2	766	834	908	1006	1105
MEETER left corner, height 1, length 80	<b>S108-1CLH180</b>	798	2,5	820	897	981	1093	1205
MEETER right corner, height 1, length 80	<b>S108-1CRH180</b>	798	2,5	820	897	981	1093	1205
MEETER left corner, height 1, length 100	<b>S108-1CLH1100</b>	886	2,9	912	1001	1099	1229	1359
MEETER right corner, height 1, length 100	<b>S108-1CRH1100</b>	886	2,9	912	1001	1099	1229	1359
MEETER left corner, height 1, length 120	<b>S108-1CLH1120</b>	997	3,3	1027	1128	1239	1387	1535
MEETER right corner, height 1, length 120	<b>S108-1CRH1120</b>	997	3,3	1027	1128	1239	1387	1535
MEETER left corner, height 1, length 150	<b>S108-1CLH1150</b>	1195	3,9	1230	1350	1481	1656	1831
MEETER right corner, height 1, length 150	<b>S108-1CRH1150</b>	1195	3,9	1230	1350	1481	1656	1831

\* Customer's Own Material / Price Without Fabric

PRICE LIST

Currency: € (VAT excl.)

PRODUCT NAME	CODE	COM/PWF*	FABRIC CONS.	FABRIC 1	FABRIC 2	FABRIC 3	FABRIC 4	FABRIC 5
<b>Corner modules</b>								
MEETER left corner, height 2, length 62	S108-1CLH262	869	2,8	894	981	1075	1200	1326
MEETER right corner, height 2, length 62	S108-1CRH262	869	2,8	894	981	1075	1200	1326
MEETER left corner, height 2, length 80	S108-1CLH280	946	3,2	975	1073	1181	1324	1467
MEETER right corner, height 2, length 80	S108-1CRH280	946	3,2	975	1073	1181	1324	1467
MEETER left corner, height 2, length 100	S108-1CLH2100	1002	3,6	1034	1145	1266	1428	1589
MEETER right corner, height 2, length 100	S108-1CRH2100	1002	3,6	1034	1145	1266	1428	1589
MEETER left corner, height 2, length 120	S108-1CLH2120	1128	4	1164	1287	1421	1601	1780
MEETER right corner, height 2, length 120	S108-1CRH2120	1128	4	1164	1287	1421	1601	1780
MEETER left corner, height 2, length 150	S108-1CLH2150	1393	4,6	1434	1576	1730	1936	2142
MEETER right corner, height 2, length 150	S108-1CRH2150	1393	4,6	1434	1576	1730	1936	2142
MEETER left corner, height 3, length 62	S108-1CLH362	1059	3	1086	1178	1279	1414	1548
MEETER right corner, height 3, length 62	S108-1CRH362	1059	3	1086	1178	1279	1414	1548
MEETER left corner, height 3, length 80	S108-1CLH380	1144	3,5	1176	1284	1401	1558	1715
MEETER right corner, height 3, length 80	S108-1CRH380	1154	3,5	1185	1293	1411	1567	1724
MEETER left corner, height 3, length 100	S108-1CLH3100	1212	3,9	1248	1368	1499	1673	1848
MEETER right corner, height 3, length 100	S108-1CRH3100	1212	3,9	1248	1368	1499	1673	1848
MEETER left corner, height 3, length 120	S108-1CLH3120	1355	4,5	1395	1534	1685	1887	2088
MEETER right corner, height 3, length 120	S108-1CRH3120	1319	4,5	1360	1498	1650	1851	2053
MEETER left corner, height 3, length 150	S108-1CLH3150	1644	5,3	1692	1855	2033	2270	2508
MEETER right corner, height 3, length 150	S108-1CRH3150	1644	5,3	1692	1855	2033	2270	2508
<b>Meeter pouf modules</b>								
MEETER pouf, length 60	S108-F62	382	1,4	394	437	484	547	610
MEETER pouf, length 80	S108-F80	438	1,6	452	502	555	627	699
MEETER pouf, length 100	S108-F100	480	1,8	497	552	613	693	774
MEETER pouf, length 120	S108-F120	590	2	608	670	737	826	916
MEETER pouf, length 150	S108-F150	738	2,3	758	829	907	1010	1113

\* Customer's Own Material / Price Without Fabric

Solid oak and powder-coated metal leg options are included in the module pricing. If you choose the plinth option, an additional cost will be calculated based on the total length of the module combination.

The cost of planter boxes will be calculated based on the total length of the module combination.

PLINTH	CODE	PRICE
MEETER plinth, oak (running meter)	A0803-0103	317
MEETER plinth, black laminate (running meter)	A0803-0104	317
MEETER plinth, black melamine (running meter)	A0803-0102	205

TABLE	CODE	PRICE
MEETER side table (Ø 33 cm)	S108-T1	440

ELECTRICAL OUTLET	CODE	PRICE
Berker Integro Flow 220V + USB A & C	S114-EL11	521

SAMPLE MODULES





Continental factory restaurant in Kaunas, Lithuania. Photo: Norbert Tukaji

**Shallow seating** makes the Meeter perfect for tighter places



Finnish Transport Infrastructure Agency in Helsinki, Finland. Photo: Hannakaisa Pekkala

# Meeter Round

Available at  

## Sofa modules

Design: Argo Tamm

Meeter Round, an evolution of the straight module, streamlines rows of seating. Its gently rounded silhouette and smooth curves optimise available space, creating an inviting seating area perfect for waiting rooms, cafés, and other public spaces.



Welcome Zone



Social Zone

Create compact waiting spots

Add elegance with a rounded silhouette

## PRODUCT INFORMATION

### Versions

Available in 3 different heights and 2 different shapes

### Modularity

Modules can be connected together

### Legs

Available with regular legs and plinth

### Accessories

Attached side table to add functionality

### Warranty

5 years

### Sustainability

Based on principles of the circular economy

### Certification



## STANDARD MATERIALS

### Frame

Solid wood and plywood

### Seat & backrest

Durable HR foam; fire retardant HR foam on request

### Legs

Solid oak / Powder-coated metal  
 Plinth: Veneer / High-pressure laminate

### Table

Mass colored wood fibreboard / high-pressure laminate top with plywood edge; powder-coated metal frame

### Fabric upholstery

The cover material is not removable  
 Choose any fabric from **Intuit Standard Fabric Collection**

### Additional information

As part of after-sales service we offer the change of cover fabric and all other components if needed



## LEGS



Solid oak legs, stained and varnished; anti-slip soles



Powder-coated metal; anti-slip soles. Available in U-shape and straight legs



Plinth. Additional cost will apply

### Solid oak

Whitened	
Natural	
Wenge	
Black	

Other finishing options available on request.

### Powder-coated metal

Jet Black RAL 9005	
<b>Plinth</b>	
Natural oak veneer	
Black high-pressure laminate	

## TABLE

### Tabletop

#### High-pressure laminate, plywood edge

Black	
-------	--

#### Mass-colored wood fibreboard

Grey	
Black	

### Table frame

#### Powder-coated metal

Jet Black RAL 9005	
--------------------	--

Other finishing options available on request.



Meeter side table

## DIMENSIONS

### Modules

Seat depth: 45 cm / height: 46 cm

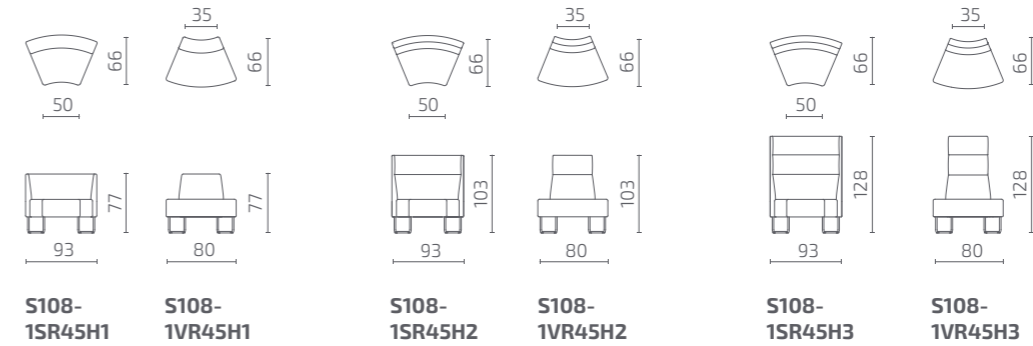

All dimensions provided in centimetres.

## SAMPLE COMBINATIONS

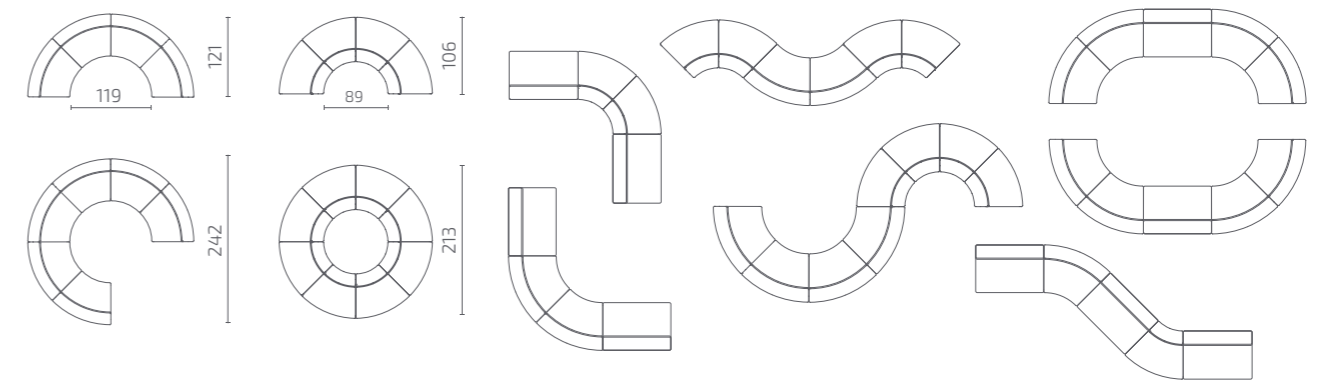

## PRICE LIST

Currency: € (VAT excl.)

PRODUCT NAME	CODE	COM/PWF*	FABRIC CONS.	FABRIC 1	FABRIC 2	FABRIC 3	FABRIC 4	FABRIC 5
MEETER round module with inner radius H1	S108-1SR45H1	1246	2,9	1272	1361	1458	1588	1718
MEETER round module with outer radius H1	S108-1VR45H1	1265	3,9	1300	1420	1551	1726	1900
MEETER round module with inner radius H2	S108-1SR45H2	1405	3,2	1434	1533	1640	1784	1927
MEETER round module with outer radius H2	S108-1VR45H2	1432	4,6	1473	1615	1770	1976	2182
MEETER round module with inner radius H3	S108-1SR45H3	1639	3,4	1669	1774	1888	2041	2193
MEETER round module with outer radius H3	S108-1VR45H3	1673	5,2	1720	1880	2055	2288	2520

\* Customer's Own Material / Price Without Fabric

Solid oak and powder-coated metal leg options are included in the module pricing. If you choose the plinth option, an additional cost will be calculated based on the total length of the module combination.

TABLE	CODE	PRICE
MEETER side table (Ø 33 cm)	S108-T1	440

### Table



S108-T1

# Meeter Sofa & Armchair

Available at  

## Sofa and armchair

Design: Argo Tamm

The modern, simple lines of the Armchair & Sofa come in standard dimensions. Available in three widths, the modules seat one, two, or three people side by side. Choose from three backrest heights – the higher, the more private.



## PRODUCT INFORMATION

### Versions

Available in 3 different heights and 3 different sizes

### Legs

Available with regular legs and plinth

### Accessories

Attached side table to add functionality  
 Custom-made planter boxes to offer an organic touch of privacy

### Electrical outlet

Intergrated electrical outlet

### Warranty

10 years

### Sustainability

Based on principles of the circular economy

### Test & Certification

- L2 European Standard strength, durability and safety certificate
- EU Ecolabel Certified



## STANDARD MATERIALS

### Frame

Solid wood and plywood

### Seat & backrest

Durable HR foam; fire retardant HR foam on request

### Legs

Solid oak / Powder-coated metal  
 Plinth: Veneer / Melamine / High-pressure laminate

### Tables

Mass colored wood fibre board / high-pressure laminate top with plywood edge; powder-coated metal frame

### Planter box

Veneer / Melamine / High-pressure laminate

### Fabric upholstery

The cover material is not removable  
 Choose any fabric from **Intuit Standard Fabric Collection**

### Additional information

As part of after-sales service we offer the change of cover fabric and all other components if needed



Welcome Zone



Social Zone

Create compact waiting spots

Elevate privacy with stylish high walls

## LEGS



Solid oak legs, stained and varnished; anti-slip soles



Powder-coated metal; anti-slip soles. Available in U-shape and straight legs



Plinth  
Additional cost will apply

### Solid oak

Whitened	
Natural	
Wenge	
Black	

Other finishing options available on request.

### Powder-coated metal

Jet Black RAL 9005	
--------------------	--

### Plinth

Natural oak veneer	
Black melamine	
Black high-pressure laminate	

## TABLE

### Tabletop

**High-pressure laminate, plywood edge**

Black	
-------	--

**Mass-colored wood fibreboard**

Grey	
Black	

### Table frame

**Powder-coated metal**

Jet Black RAL 9005	
--------------------	--

Other finishing options available on request.



Meeter side table

## PLANTER BOX

Natural oak veneer	
Black melamine	
Black high-pressure laminate	

Other finishing options available on request.



## ELECTRICAL OUTLET

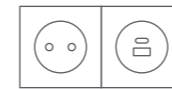

**220V + USB A & C**

Other electrical outlet combinations available on request.

**Berker Integro Flow**  
Color: Anthracite Matt

Available options DK, EU, FR, UK



## DIMENSIONS

### Armchair and sofa

Seat depth: 45 cm / Seat height: 46 cm

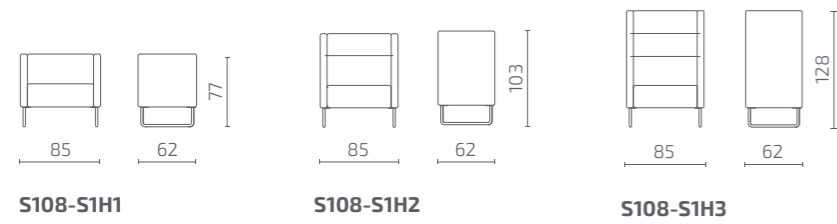

S108-S1H1

S108-S1H2

S108-S1H3

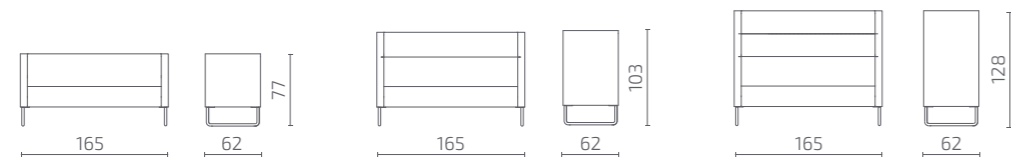

S108-S2H1

S108-S2H2

S108-S2H3

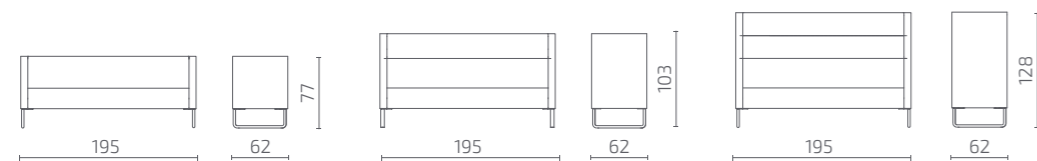

S108-S3H1

S108-S3H2

S108-S3H3

All dimensions provided in centimetres.



Armchair / H1

Armchair / H2

Armchair / H3



Sofa 2-Seat / H1

Sofa 2-Seat / H2

Sofa 2-Seat / H3

### Table



S108-T1

### Planter boxes

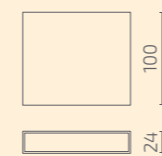
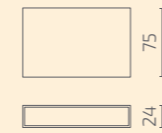

Length tailored to Meeter sofa

### Inner dimensions

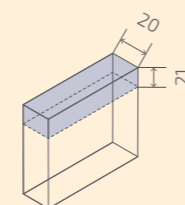

## PRICE LIST

Currency: € (VAT excl.)

PRODUCT NAME	CODE	COM/PWF*	FABRIC CONS.	FABRIC 1	FABRIC 2	FABRIC 3	FABRIC 4	FABRIC 5
MEETER armchair H1	S108-S1H1	1186	3,5	1217	1325	1442	1599	1756
MEETER armchair H2	S108-S1H2	1320	4,6	1361	1503	1658	1864	2070
MEETER armchair H3	S108-S1H3	1438	5,6	1488	1661	1849	2100	2351
MEETER Sofa 2-Seat H1	S108-S2H1	1438	5,2	1485	1645	1820	2053	2286
MEETER Sofa 2-Seat H2	S108-S2H2	1547	6,3	1604	1798	2010	2292	2574
MEETER Sofa 2-Seat H3	S108-S2H3	1848	7,5	1915	2146	2398	2734	3070
MEETER Sofa 3-Seat H1	S108-S3H1	1612	5,8	1664	1843	2038	2298	2557
MEETER Sofa 3-Seat H2	S108-S3H2	1787	6,9	1849	2061	2293	2602	2911
MEETER Sofa 3-Seat H3	S108-S3H3	1942	8,5	2019	2281	2566	2947	3328

\* Customer's Own Material / Price Without Fabric

Solid oak and powder-coated metal leg options are included in the module pricing. If you choose the plinth option, an additional cost will be applied.

The cost of planter boxes will be calculated based on the total length of the module combination.

PLINTH	CODE	PRICE
MEETER armchair plinth (75 cm), oak	A0803-0326	238
MEETER armchair plinth (75 cm), black laminate	A0803-0327	238
MEETER armchair plinth (75 cm), black melamine	A0803-0325	154
MEETER Sofa 2-Seat plinth (155 cm), oak	A0803-0313	491
MEETER Sofa 2-Seat plinth (155 cm), black laminate	A0803-0314	491
MEETER Sofa 2-Seat plinth (155 cm), black melamine	A0803-0312	317
MEETER Sofa 3-Seat plinth (185 cm), oak	A0803-0316	586
MEETER Sofa 3-Seat plinth (185 cm), black laminate	A0803-0315	586
MEETER Sofa 3-Seat plinth (185 cm), black melamine	A0803-0317	379

TABLE	CODE	PRICE
MEETER side table (Ø 33 cm)	S108-T1	440

ELECTRICAL OUTLET	CODE	PRICE
Berker Integro Flow 220V + USB A & C	S114-EL11	521

# Meeter Workbay

Available at  

## Workstation

Design: Argo Tamm

The calm walls of the Meeter Workbay can contain the most important of conversations, or welcome the individual in for some deep focused work. We've all found the need for quiet and calm in the middle of a busy workplace. That's why we're helping you create the perfect Concentration Zone.

Meeter Workbay's minimalist design makes it an easy addition to any open-plan office, letting you create the private spaces you need.



## PRODUCT INFORMATION

### Versions

Available in 3 different sizes

### Legs

Available with regular legs and plinth

### Accessories

Additional tables to add functionality to the seating area

### Electrical outlet

Integrated electrical outlet

### Warranty

5 years

### Sustainability

Embraces the principles of circular design

### Test & Certification

- L1 European Standard strength, durability and safety certificate
- EU Ecolabel Certified



## STANDARD MATERIALS

### Frame

Solid wood and plywood

### Seat & backrest

Durable HR foam; fire retardant HR foam on request

### Wall fastenings

Powder-coated metal

### Legs

Solid oak / Powder-coated metal  
 Plinth: Veneer / Melamine / High-pressure laminate

### Tables

Matt high-pressure laminate, or mass-colored wood fibreboard top with powder-coated metal legs

### Fabric upholstery

The cover material is not removable  
 Choose any fabric from **Intuit Standard Fabric Collection**

### Additional information

As part of after-sales service we offer the change of cover fabric and all other components if needed

Finnish Transport Infrastructure Agency in Helsinki, Finland. Photo: Hannakaisa Pekkala



Collaboration Zone



Concentration Zone

Divide your space organically

Give the option of focus and seclusion

Cut down on background noise

Hold your own private meeting

## LEGS



Solid oak legs, stained and varnished; anti-slip soles



Powder-coated metal; anti-slip soles. Available in U-shape and straight legs



Plinth  
Additional cost will apply

### Solid oak

Whitened	
Natural	
Wenge	
Black	

### Powder-coated metal

Jet Black RAL 9005	
--------------------	--

### Plinth

Natural oak veneer	
Black melamine	
Black high-pressure laminate	

Other finishing options available on request.

## TABLES



Aide cafeteria / work tables

### Aide tabletop

#### High-pressure laminate

Alpine White Egger W1100 PM	
Soft Black Egger U899 PM	
Stone Green Egger U665 PM	
Garnet Red Egger U399 PM	

### Aide table legs

#### Powder-coated metal

Signal White RAL 9003	
Jet Black RAL 9005	
Tarpaulin Grey RAL 7010	
Black Red RAL 3007	

Other finishing options available on request.

## ELECTRICAL OUTLET

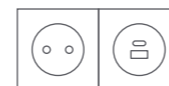

220V + USB A & C

Other electrical outlet combinations available on request.



August table with plywood edge

### August tabletop

#### High-pressure laminate, plywood edge

Black	
-------	--

#### Mass-colored wood fibreboard

Grey	
Black	

### August table legs

#### Powder-coated metal

Jet Black RAL 9005	
--------------------	--

Ev. Hochschule in Freiburg, Germany



**Berker Integro Flow**  
Color: Anthracite Matt

Available options DK, EU, FR, UK

## DIMENSIONS

### Workbay

Seat height: 46 cm

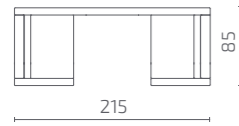
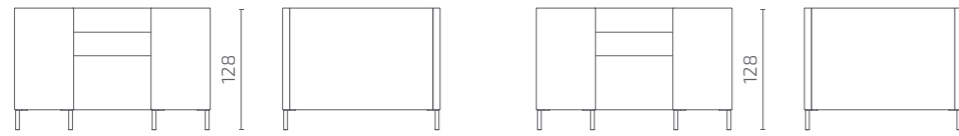

**S108-WS1H3**

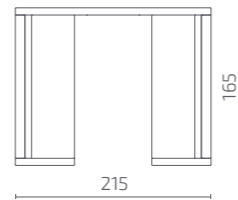

**S108-WS2H3**

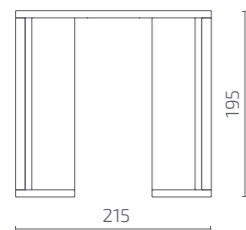
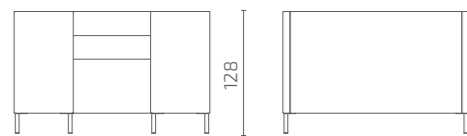

**S108-WS3H3**

All dimensions provided in centimetres.



## Tables

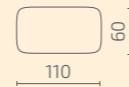
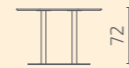

**S128-T1M**  
AIDE table



**S128-T3M**  
AIDE table

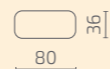
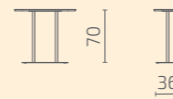

**S101-T1**  
AUGUST table

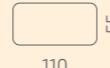
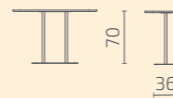

**S101-T3**  
AUGUST table

## PRICE LIST

Currency: € (VAT excl.)

PRODUCT NAME	CODE	COM/ PWF*	FABRIC CONS.	FABRIC 1	FABRIC 2	FABRIC 3	FABRIC 4	FABRIC 5
MEETER Workbay 1-Seat	<b>S108-WS1H3</b>	3070	12,5	3182	3567	3987	4547	5107
MEETER Workbay 2-Seat	<b>S108-WS2H3</b>	3933	16,4	4081	4586	5137	5871	6606
MEETER Workbay 3-seat	<b>S108-WS3H3</b>	4057	18,1	4220	4777	5385	6196	7007

\* Customer's Own Material / Price Without Fabric

Solid oak and powder-coated metal leg options are included in the module pricing. If you choose the plinth option, an additional cost will be applied.

PLINTH	CODE	PRICE
MEETER Workbay 1-Seat plinth (75 cm x2), oak	<b>A0803-0326 x 2</b>	475
MEETER Workbay 1-Seat plinth (75 cm x2), black laminate	<b>A0803-0327 x 2</b>	475
MEETER Workbay 1-Seat plinth (75 cm x2), black melamine	<b>A0803-0325 x 2</b>	307
MEETER Workbay 2-Seat plinth (155 cm x2), oak	<b>A0803-0313 x 2</b>	981
MEETER Workbay 2-Seat plinth (155 cm x2), black laminate	<b>A0803-0314 x 2</b>	981
MEETER Workbay 2-Seat plinth (155 cm x2), black melamine	<b>A0803-0312 x 2</b>	634
MEETER Workbay 3-Seat plinth (185 cm x2), oak	<b>A0803-0316 x 2</b>	1171
MEETER Workbay 3-Seat plinth (185 cm x2), black laminate	<b>A0803-0315 x 2</b>	1171
MEETER Workbay 3-Seat plinth (185 cm x2), black melamine	<b>A0803-0317 x 2</b>	757

TABLES	CODE	PRICE
AIDE cafeteria/work table (110x60x72 cm)	<b>S128-T1M</b>	718
AIDE cafeteria/work table (139x60x72 cm)	<b>S128-T3M</b>	728
AUGUST work table (80x36x70 cm)	<b>S101-T1</b>	415
AUGUST work table (110x55x70 cm)	<b>S101-T3</b>	549

ELECTRICAL OUTLET	CODE	PRICE
Berker Integro Flow 220V + USB A & C	<b>S114-EL11</b>	521



# Meeter Chair

## Dining chair

Design: Argo Tamm

Elevating the Meeter product line, the latest addition is the Meeter chair that boasts sleek, contemporary lines, perfectly complementing its sofa counterparts.



## PRODUCT INFORMATION

**Warranty**  
5 years

**Sustainability**  
Based on principles of the circular economy

### Certification



## STANDARD MATERIALS

**Frame**  
Plywood

**Seat & backrest**  
Durable HR foam; fire retardant HR foam on request

**Legs**  
Powder-coated metal, anti-slip soles

**Armrest**  
Plywood with high-pressure laminate on top

**Fabric upholstery**  
The cover material is not removable  
Choose any fabric from **Intuit Standard Fabric Collection**

**Additional information**  
As part of after-sales service we offer the change of cover fabric and all other components if needed

## DIMENSIONS

Seat depth: 45 cm

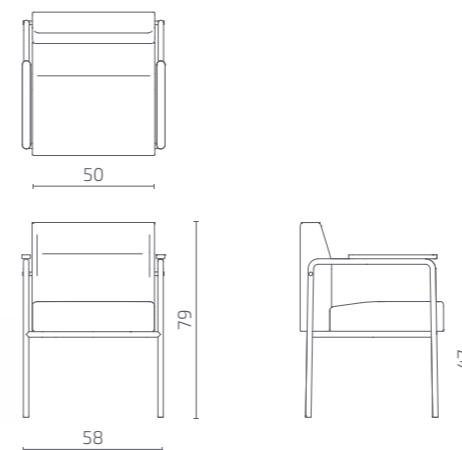

S108-ST1

All dimensions provided in centimetres.

## FINISHING OPTIONS

### Legs

#### Powder-coated metal

Jet Black RAL 9005

### Armrest

#### High-pressure laminate

Black

Other finishing options available on request.

## PRICE LIST

Currency: € (VAT excl.)

PRODUCT NAME	CODE	COM/PWF*	FABRIC CONS.	FABRIC 1	FABRIC 2	FABRIC 3	FABRIC 4	FABRIC 5
MEETER dining chair	S108-ST1	828	1,4	840	884	931	993	1056

\* Customer's Own Material / Price Without Fabric



Welcome Zone



Social Zone



Collaboration Zone

# Sans

Available at  

## Soft work sofa

Design: Argo Tamm

The Sans versatile sofa family provides a welcoming resting place in the welcome and social areas. Comfortable and practical for a communal space, the Sans is available as a classic sofa, or with an integral table. And, when equipped with eye-level walls, it's the perfect home for intimate conversations in any breakout spaces. Pop down your coffee cup, lean back, and enjoy the clean lines and sociable layout.



Welcome Zone



Social Zone



Collaboration Zone

Divide your space organically

Offer up moments of rest and relaxation

Make your visitors feel at home

## PRODUCT INFORMATION

### Versions

Many different sizes and combinations

### Accessories

Various additional tables  
 Additional pillows

### Electrical outlet

Under the seating mounted to the frame  
 Integrated in the table top

### Warranty

5 years

### Sustainability

Based on principles of the circular economy

### Test & Certification

L1 European Standard strength, durability and safety certificate



## STANDARD MATERIALS

### Frame

Solid wood and plywood

### Seat & backrest

Durable and fireproof HR-foam; nosag springs; fixed seat and back cushions

### Legs

Powder-coated metal frame; plastic soles

### Tables

High-pressure laminate table top with plywood edge, powder-coated metal frame

### Pillows

Feather filling

### Fabric upholstery

The cover material is not removable  
 Choose any fabric from **Intuit Standard Fabric Collection**

### Additional information

As part of after-sales service we offer the change of cover fabric and all other components if needed

Co-working space NUUUORK at Berlin Airport, Germany. Photo: Ariane Brille



## FINISHING OPTIONS

### Leg frame

#### Powder-coated metal

Jet Black RAL 9005



### Tabletop

#### High-pressure laminate, plywood edge

Black



### Table frame

#### Powder-coated metal

Jet Black RAL 9005



Other finishing options available on request.



## ELECTRICAL OUTLET

### Under the seating attached to the frame

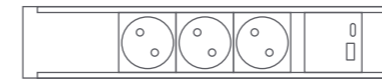

3x 220V + USB A & C

### Integrated in the table top



220V + USB A



220V + USB A & C

Other electrical outlet combinations available on request.

### Bachmann Power Strip

Color: Black Matt

Available options DK, EU, FR, UK

### Powerdot Compact 61

Color: Black Matt

Available options EU, FR, UK

### Powerdot 16

Color: Black Matt

Available options DK, EU, FR

Savant Zorg office in the Netherlands



SAMPLE COMBINATIONS

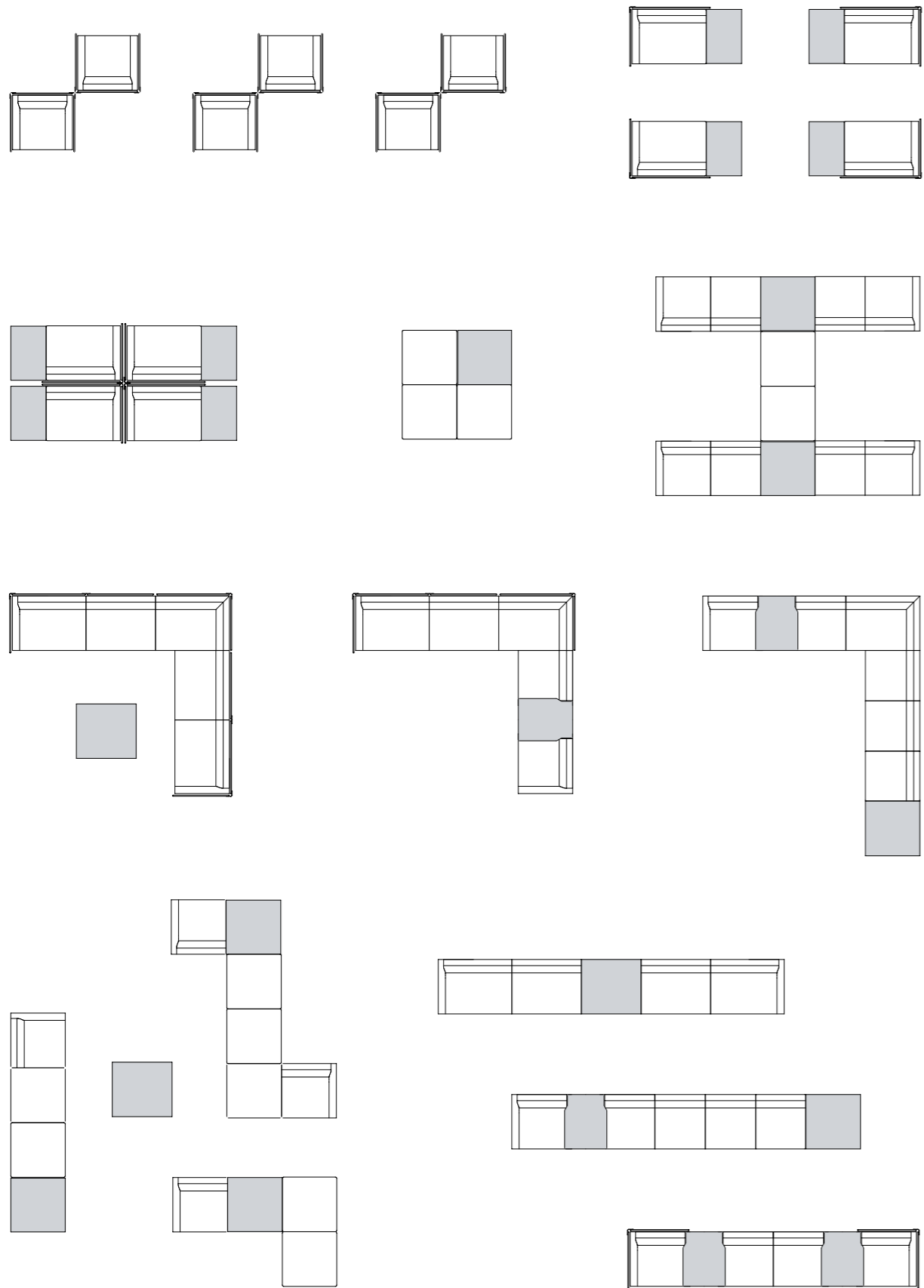

## DIMENSIONS

### Individual modules

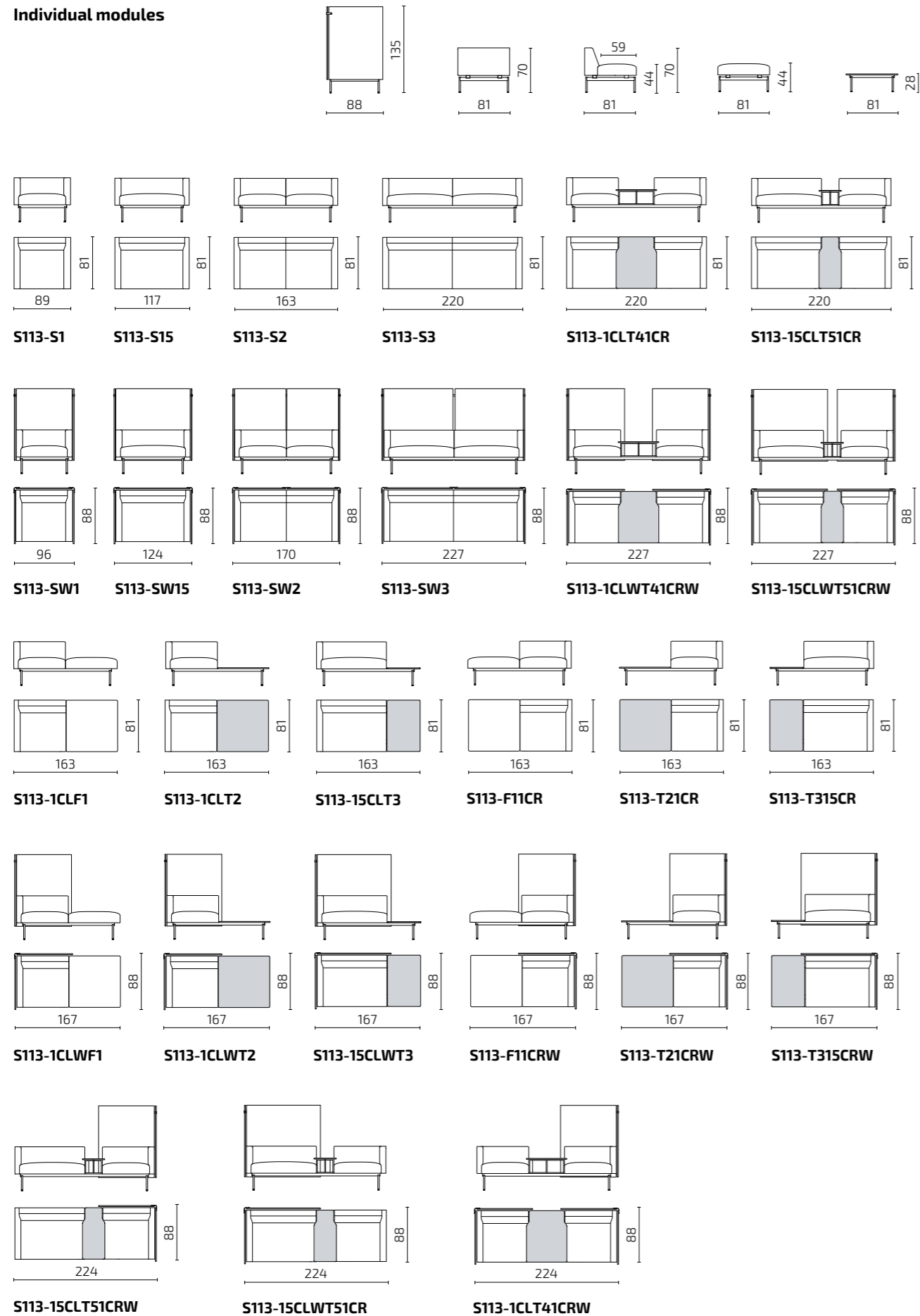

All dimensions provided in centimetres.

## PRICE LIST

Currency: € (VAT excl.)

PRODUCT NAME	CODE	COM/PWF*	FABRIC CONS.	FABRIC 1	FABRIC 2	FABRIC 3	FABRIC 4	FABRIC 5
<b>Individual models</b>								
SANS armchair	<b>S113-S1</b>	976	3,5	1007	1115	1232	1389	1546
SANS wide armchair	<b>S113-S15</b>	1156	4,1	1193	1319	1457	1641	1824
SANS sofa 2-Seat	<b>S113-S2</b>	1472	5,3	1520	1683	1861	2099	2336
SANS sofa 3-Seat	<b>S113-S3</b>	1790	6,4	1847	2044	2260	2546	2833
SANS sofa 2-Seat with medium table	<b>S113-1CLT41CR</b>	2252	5,2	2299	2459	2634	2867	3100
SANS sofa 2-Seat with small table	<b>S113-15CLT51CR</b>	2323	5,8	2375	2554	2749	3009	3269
SANS armchair with walls	<b>S113-SW1</b>	1816	9,2	1899	2183	2492	2904	3316
SANS wide armchair with walls	<b>S113-SW15</b>	1923	10,4	2016	2337	2686	3152	3618
SANS sofa 2-Seat with walls	<b>S113-SW2</b>	2553	12,5	2666	3051	3471	4031	4591
SANS sofa 3-Seat with walls	<b>S113-SW3</b>	2812	14,8	2945	3401	3898	4561	5224
SANS sofa 2-Seat with medium table and walls	<b>S113-1CLWT41CRW</b>	3238	12,5	3351	3736	4156	4716	5276
SANS sofa 2-Seat with small table and walls	<b>S113-15CLWT51CRW</b>	3253	13,6	3376	3794	4251	4861	5470
SANS left side 1-Seat with pouf	<b>S113-1CLF1</b>	1294	3,6	1326	1437	1558	1719	1880
SANS left side 1-Seat with wide table	<b>S113-1CLT2</b>	1262	2,7	1287	1370	1460	1581	1702
SANS left side 1,5-Seat with small table	<b>S113-15CLT3</b>	1308	3,3	1338	1440	1551	1698	1846
SANS right side 1-Seat with pouf	<b>S113-F11CR</b>	1294	3,6	1326	1437	1558	1719	1880
SANS right side 1-Seat with wide table	<b>S113-T21CR</b>	1262	2,7	1287	1370	1460	1581	1702
SANS right side 1,5-Seat with small table	<b>S113-T315CR</b>	1308	3,3	1338	1440	1551	1698	1846
SANS left side 1-Seat with pouf and walls	<b>S113-1CLWF1</b>	1780	7,2	1845	2067	2309	2631	2954
SANS left side 1-Seat with wide table and walls	<b>S113-1CLWT2</b>	1777	6,3	1834	2028	2239	2522	2804
SANS left side 1,5-Seat with small table and walls	<b>S113-15CLWT3</b>	1774	7,5	1841	2072	2324	2660	2996
SANS right side 1-Seat with pouf and walls	<b>S113-F11CRW</b>	1780	7,2	1845	2067	2309	2631	2954
SANS right side 1-Seat with wide table and walls	<b>S113-T21CRW</b>	1777	6,3	1834	2028	2239	2522	2804
SANS right side 1,5-Seat with small table and walls	<b>S113-T315CRW</b>	1774	7,5	1841	2072	2324	2660	2996
SANS 1,5-Seat with corner (left) / small table / 1-Seat with corner and wall (right)	<b>S113-15CLT51CRW</b>	2964	9,9	3053	3358	3690	4134	4577
SANS 1,5-Seat with corner and wall (left) / small table / 1-Seat with corner (right)	<b>S113-15CLWT51CR</b>	2973	10,5	3068	3391	3744	4214	4685
SANS 1-Seat with corner (left) / medium table / 1-Seat with corner and wall (right)	<b>S113-1CLT41CRW</b>	3088	9,3	3172	3458	3771	4188	4604

\* Customer's Own Material / Price Without Fabric

## DIMENSIONS

### Daybed

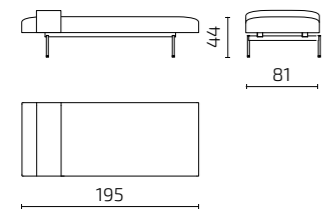

**S113-DB1**

### Poufs and tables

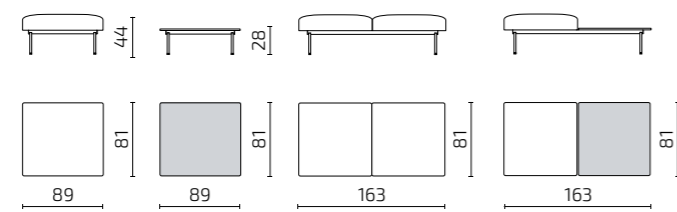

**S113-F**

**S113-T1**

**S113-F2**

**S113-F1T2**

### Pillows

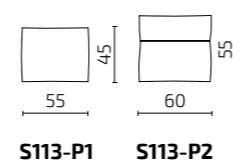

**S113-P1**

**S113-P2**

### Modules to combine

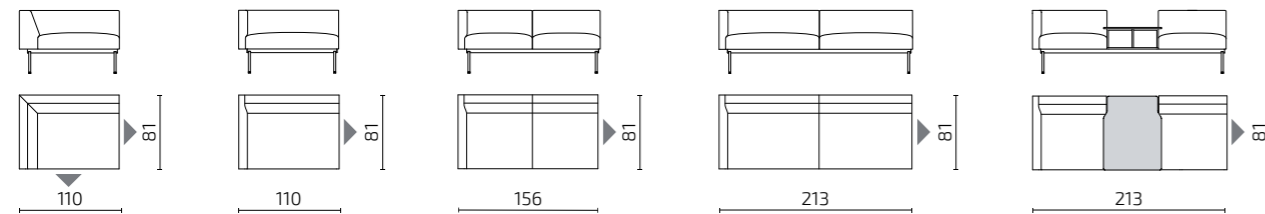

**S113-CL**

**S113-15CL**

**S113-2CL**

**S113-3CL**

**S113-1CLT41**

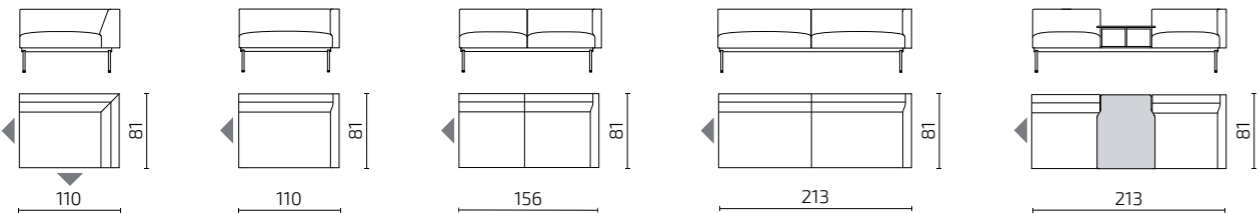

**S113-CR**

**S113-15CR**

**S113-2CR**

**S113-3CR**

**S113-1T41CR**

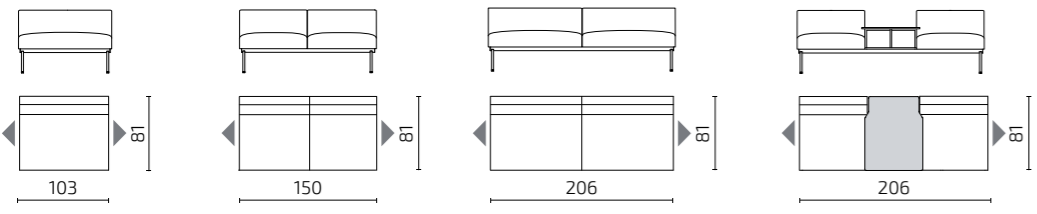

**S113-15**

**S113-2**

**S113-3**

**S113-1T41**

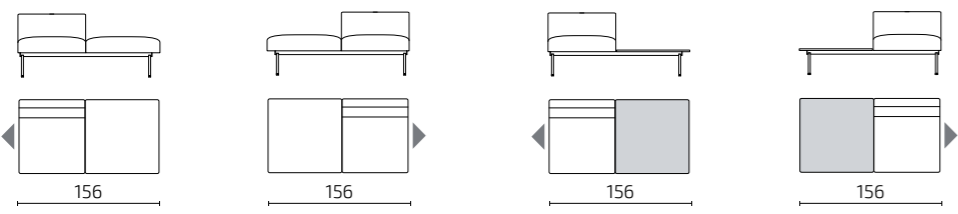

**S113-1F1**

**S113-F11**

**S113-1T2**

**S113-T21**

All dimensions provided in centimetres.

## PRICE LIST

Currency: € (VAT excl.)

PRODUCT NAME	CODE	COM/ PWF*	FABRIC CONS.	FABRIC 1	FABRIC 2	FABRIC 3	FABRIC 4	FABRIC 5
<b>Daybed / Poufs and tables / Pillows</b>								
SANS daybed	<b>S113-DB1</b>	1177	3,0	1204	1297	1398	1532	1666
SANS 1-Seat pouf	<b>S113-F</b>	646	1,8	662	717	778	858	939
SANS wide table	<b>S113-T1</b>	636						
SANS 2-Seat pouf	<b>S113-F2</b>	1083	2,7	1107	1190	1281	1402	1523
SANS 1-Seat pouf with wide table	<b>S113-F1T2</b>	1038	1,8	1054	1109	1170	1250	1331
SANS small pillow (55x45 cm)	<b>S113-P1</b>	75	0,8	82	107	134	170	205
SANS large pillow (60x55 cm)	<b>S113-P2</b>	86	0,8	93	118	145	181	217
<b>Modules to combine</b>								
SANS 1-Seat corner module (left)	<b>S113-CL</b>	1029	3,0	1056	1148	1249	1384	1518
SANS 1-Seat corner module (right)	<b>S113-CR</b>	1029	3,0	1056	1148	1249	1384	1518
SANS 1.5-Seat module with corner (left)	<b>S113-15CL</b>	1056	3,3	1086	1188	1299	1446	1594
SANS 1.5-Seat module with corner (right)	<b>S113-15CR</b>	1056	3,3	1086	1188	1299	1446	1594
SANS 2-Seat module with corner (left)	<b>S113-2CL</b>	1539	4,4	1579	1714	1862	2059	2256
SANS 2-Seat module with corner (right)	<b>S113-2CR</b>	1539	4,4	1579	1714	1862	2059	2256
SANS 3-Seat module with corner (left)	<b>S113-3CL</b>	1714	5,5	1763	1932	2117	2364	2610
SANS 3-Seat module with corner (right)	<b>S113-3CR</b>	1714	5,5	1763	1932	2117	2364	2610
SANS module with corner and medium table (left)	<b>S113-1CLT41</b>	2138	4,4	2178	2313	2461	2658	2855
SANS module with corner and medium table (right)	<b>S113-1T41CR</b>	2138	4,4	2178	2313	2461	2658	2855
SANS 1.5-Seat middle module	<b>S113-15</b>	909	2,5	931	1008	1092	1204	1316
SANS 2-Seat middle module	<b>S113-2</b>	1215	3,6	1248	1358	1479	1641	1802
SANS 3-Seat middle module	<b>S113-3</b>	1510	4,7	1553	1697	1855	2066	2276
SANS 1-Seat/medium table/ 1-Seat middle module	<b>S113-1T41</b>	1663	3,6	1696	1806	1927	2089	2250
SANS left side 1-Seat module with pouf	<b>S113-1F1</b>	1174	2,8	1199	1286	1380	1505	1631
SANS right side 1-Seat module with pouf	<b>S113-F11</b>	1174	2,8	1199	1286	1380	1505	1631
SANS left side 1-Seat module with middle table	<b>S113-1T2</b>	1176	1,9	1194	1252	1316	1401	1486
SANS right side 1-Seat module with middle table	<b>S113-T21</b>	1176	1,9	1194	1252	1316	1401	1486

\* Customer's Own Material / Price Without Fabric

**Modules to combine**

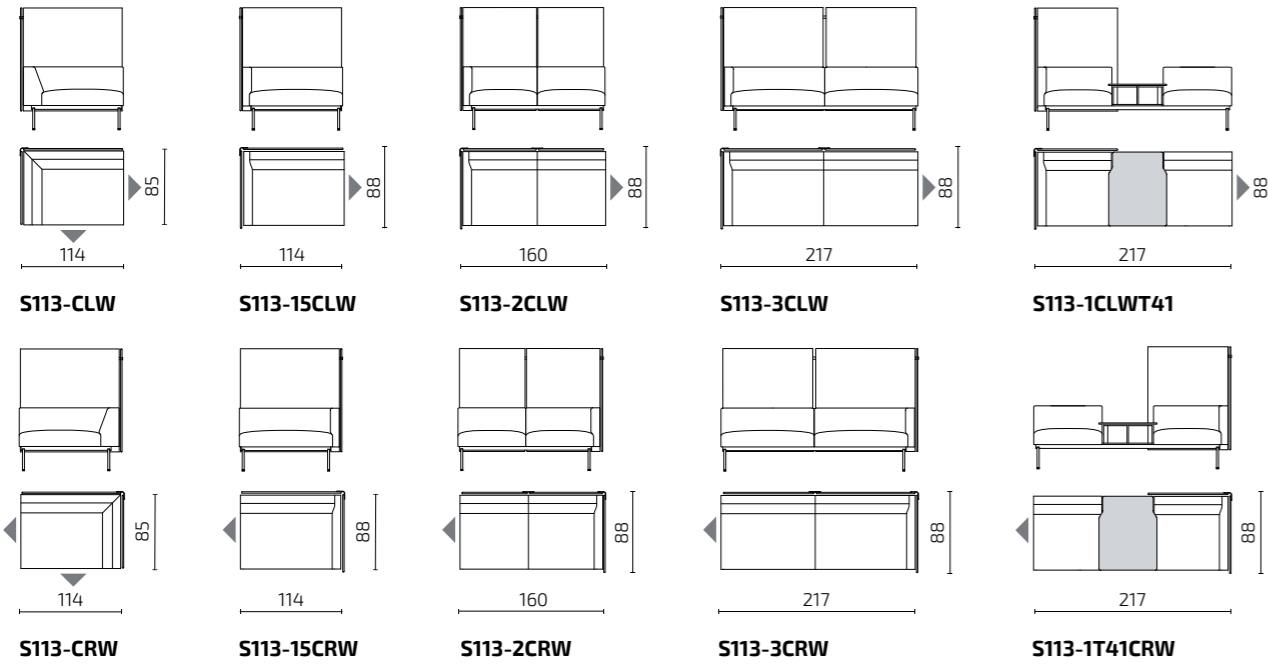

All dimensions provided in centimetres.

PRODUCT NAME	CODE	COM/ PWF*	FABRIC CONS.	FABRIC 1	FABRIC 2	FABRIC 3	FABRIC 4	FABRIC 5
<b>Modules to combine</b>								
SANS 1-Seat corner module with walls (left)	<b>S113-CLW</b>	1465	6,9	1527	1739	1971	2280	2589
SANS 1-Seat corner module with walls (right)	<b>S113-CRW</b>	1465	6,9	1527	1739	1971	2280	2589
SANS 1.5-Seat module with corner and walls (left)	<b>S113-15CLW</b>	1508	7,3	1573	1798	2043	2370	2697
SANS 1.5-Seat module with corner and walls (right)	<b>S113-15CRW</b>	1770	7,3	1836	2061	2306	2633	2960
SANS 2-Seat module with corner and walls (left)	<b>S113-2CLW</b>	2116	9,4	2200	2490	2806	3227	3648
SANS 2-Seat module with corner and walls (right)	<b>S113-2CRW</b>	2116	9,4	2200	2490	2806	3227	3648
SANS 3-Seat module with corner and walls (left)	<b>S113-3CLW</b>	2413	11,7	2519	2879	3272	3796	4320
SANS 3-Seat module with corner and walls (right)	<b>S113-3CRW</b>	2413	11,7	2519	2879	3272	3796	4320
SANS module with corner, medium table and walls (left)	<b>S113-1CLWT41</b>	2594	8,0	2666	2912	3181	3540	3898
SANS module with corner, medium table and walls (right)	<b>S113-1T41CRW</b>	2594	8,0	2666	2912	3181	3540	3898

\* Customer's Own Material / Price Without Fabric



# Sofi

## Sofa & pouf system

Design: Janno Nõu, Iseasi

Kick back and relax. With their fresh look and slim proportions, the Sofi sofa and pouf make even the smallest Welcome Zones inviting. Your visitors will want to put their feet up and settle in with a coffee – so comfy they won't even mind if you're a little late!



Welcome Zone

Create cosy spots in even the smallest spaces

Move around as the conversation flows

Make your guests feel at home

## PRODUCT INFORMATION

### Versions

Available as a sofa, bench and 2 pouf shapes

### Warranty

5 years

### Sustainability

Based on principles of the circular economy

### Certification



## STANDARD MATERIALS

### Frame

Solid wood and plywood

### Seat & backrest

Durable HR foam; fire retardant HR foam on request

### Legs

Stained solid oak

### Fabric upholstery

The cover fabric is not removable

Choose any fabric from **Intuit Standard Fabric Collection**

### Additional information

As part of after-sales service we offer the change of cover fabric and all other components if needed

Kääriku Sports Center, Estonia. Photo: Tõnu Runnel



## LEGS

### Solid oak

Whitened

Natural

Wenge

Black

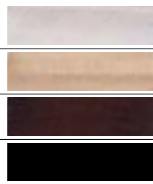

Other finishing options available on request.



## DIMENSIONS

Seat depth: 48 cm

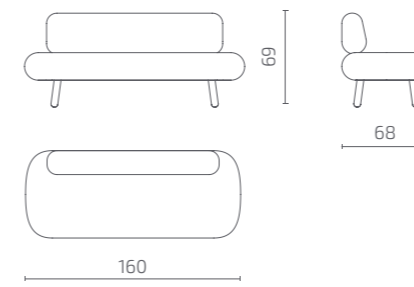

**S105-S2**

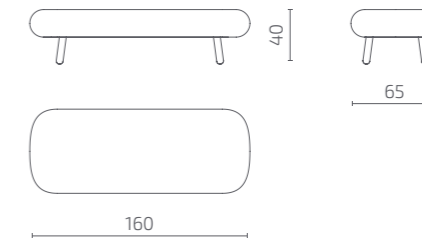

**S105-F2**

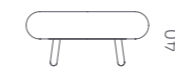

**S105-F90**



**S105-F1**

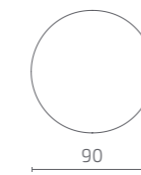

All dimensions provided in centimetres.

## PRICE LIST

Currency: € (VAT excl.)

PRODUCT NAME	CODE	COM/ PWF*	FABRIC CONS.	FABRIC 1	FABRIC 2	FABRIC 3	FABRIC 4	FABRIC 5
SOFI sofa 2-Seat	<b>S105-S2</b>	1180	3,3	1209	1311	1422	1570	1717
SOFI pouf 2-Seat	<b>S105-F2</b>	918	2,9	944	1034	1131	1261	1391
SOFI round pouf	<b>S105-F90</b>	604	1,8	620	675	736	816	897
SOFI rectangular pouf	<b>S105-F1</b>	600	1,6	615	664	718	790	861

\* Customer's Own Material / Price Without Fabric



# Spot

## Multifunctional seating furniture

Design: Pent Talvet, Iseasi

Spot is a centre of attraction, one that dominates both the Welcome and Social zones. The four modules can be used to create varied solutions for one or more seated individuals. Whether Spot provides privacy for someone waiting or facilitates communication depends entirely on its placement.

Always practical, Spot is a combination of an inviting seating area and a useful supporting surface. The shelves surrounding the seat form ideal supports on which to place a computer or simply to lean against. The shelves feature integrated sockets, enabling Spot to serve as a workspace, if desired. In addition to books and houseplants, the shelves confidently support various furnishing elements that enliven the space. Spot also makes it easy to divide rooms into zones.



Welcome Zone



Social Zone



Collaboration Zone

Can serve several functions

A comfortable place to wait

Create an inviting atmosphere

## PRODUCT INFORMATION

### Versions

Available in 3 different sized modules

### Modularity

Modules can be connected together

### Electrical outlet

Integrated electrical outlet

### Warranty

5 years

### Sustainability

Based on principles of the circular economy

### Certification



## STANDARD MATERIALS

### Frame

Plywood

### Seat and backrest

Durable HR foam; fire retardant HR foam on request

### Legs

Powder-coated metal frame, anti-slip soles (optional)

### Shelving

Pine plywood or oak veneer; top board high-pressure laminate

### Table

High-pressure laminate

### Fabric upholstery

The cover fabric is not removable

Choose any fabric from **Intuit Standard Fabric Collection**

### Additional information

As part of after-sales service we offer the change of cover fabric and all other components if needed



## FINISHING OPTIONS

### Leg frame

#### Powder-coated metal

Jet Black RAL 9005



### Tabletop / Top board

#### High-pressure laminate

Black



### Shelving

#### Pine plywood

Natural pine



#### Oak veneer

Natural oak



Other finishing options available on request.



## MODULES



Corner module 1-Seat



Corner module 2-Seat



Corner module 2-Seat with back shelf only



Table module

## ELECTRICAL OUTLET



220V + USB A & C



220V + USB A + data

Other electrical outlet combinations available on request.

### Powerdot 16

Color: Black Matt

Available options DK, EU, FR

### Powerdot 12

Color: Black Matt

Available options UK

## SAMPLE COMBINATIONS



## DIMENSIONS

### Left corner module 1-Seat

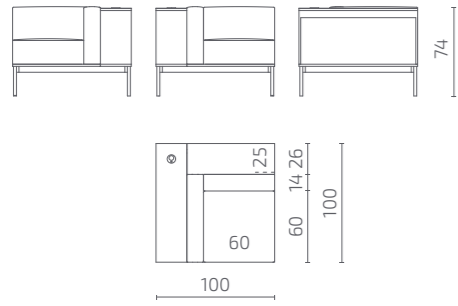

**S126-1CLA**

### Right corner module 1-Seat

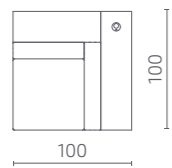

**S126-1CRA**

### Left corner module 2-Seat with back shelf only

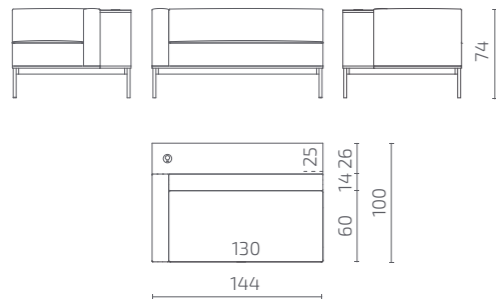

**S126-2CLC**

### Right corner module 2-Seat with back shelf only

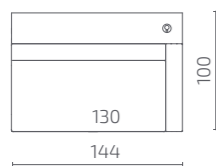

**S126-2CRC**

### Left corner module 2-Seat

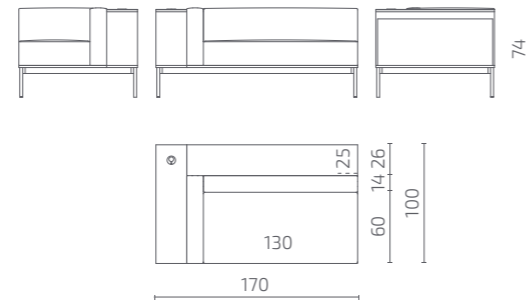

**S126-2CLB**

### Right corner module 2-Seat

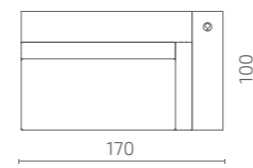

**S126-2CRB**

### Table module

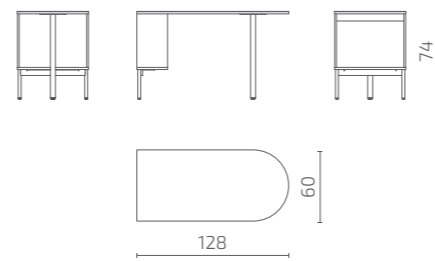

**S126-T1**

All dimensions provided in centimetres.

## PRICE LIST

Currency: € (VAT excl.)

PRODUCT NAME	CODE	COM/PWF*	FABRIC CONS.	FABRIC 1	FABRIC 2	FABRIC 3	FABRIC 4	FABRIC 5
SPOT left corner module 1-Seat with shelf	<b>S126-1CLA</b>	2669	2,7	2693	2776	2867	2988	3109
SPOT right corner module 1-Seat with shelf	<b>S126-1CRA</b>	2669	2,7	2693	2776	2867	2988	3109
SPOT left corner module 2-Seat with shelf	<b>S126-2CLB</b>	3325	3,9	3360	3480	3611	3786	3961
SPOT right corner module 2-Seat with shelf	<b>S126-2CRB</b>	3325	3,9	3360	3480	3611	3786	3961
SPOT left corner module 2-Seat with back shelf only	<b>S126-2CLC</b>	2779	3,9	2814	2934	3065	3240	3415
SPOT right corner module 2-Seat with back shelf only	<b>S126-2CRC</b>	2779	3,9	2814	2934	3065	3240	3415

\* Customer's Own Material / Price Without Fabric

TABLE MODULE	CODE	PRICE
SPOT table with back shelf (128x60 cm)	<b>S126-T1</b>	1272



# Wander

## Cosy niche sofa

Design: Lauri Visnapuu

When you combine the comfort of a home sofa with the convenience of an office sofa, you get Wander – a cosy niche sofa with high walls that provides visual separation, supports productivity, and can be easily moved around.

With modules available in three different widths, Wander offers a number of interior design options. By placing the modules opposite each other, the result is a cosy nest suitable for a private chat. When complemented with an auxiliary desk, it serves as a functional work island. Equipped with castors, Wander moves with you. Modules arranged in a row are also suitable, for a café, for example.

Wander's soft back cushions are loose and adjustable. In keeping with circular economy design, Wander's coverings are durable and easy to replace, even on your own.



Welcome Zone



Social Zone



Collaboration Zone



Concentration Zone

Can be moved around, if desired

Help make waiting more comfortable

Allows you to focus and separate

## PRODUCT INFORMATION

### Versions

Available in 3 different sizes. Additionally available as Workbays in 3 different sizes when connected with compound wall

### Legs

Lockable 360° rotating castors

### Accessories

Workbays' compound walls are equipped with tables to add functionality to the seating area

### Electrical outlet

Integrated electrical outlet

### Warranty

5 years

### Sustainability

Based on principles of the circular economy

### Certification



## STANDARD MATERIALS

### Frame

Solid wood and plywood

### Seat and backrest

Durable HR foam; fire retardant HR foam on request

### Tables

Matt high-pressure laminate top with powder-coated metal leg

### Pillows

Feather filling, attached with Velcro

### Fabric upholstery

The cover fabric is not removable

For extra acoustic attenuation acoustic fabrics recommended  
Choose any fabric from Intuit **Standard Fabric Collection**

### Additional information

As part of after-sales service we offer the change of cover fabric and all other components if needed



## FINISHING OPTIONS

### Tabletop

*High-pressure laminate*

Black



### Table leg

*Powder-coated metal*

Jet Black RAL 9005



Other finishing options available on request.



## ELECTRICAL OUTLET



**220V + USB A & C**

Other electrical outlet combinations available on request.

**Berker Integro Flow**  
Color: Anthracite Matt

*Available options DK, EU, FR, UK*



## DIMENSIONS

Seat depth: 46 cm, without pillow 63 cm  
Seat height: 46 cm

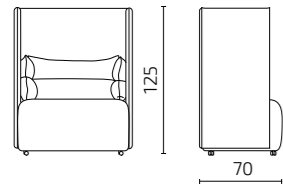

**S129-S1H3**

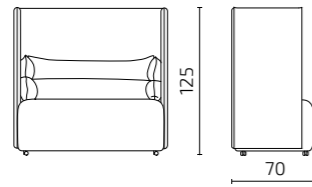
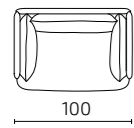

**S129-S2H3**

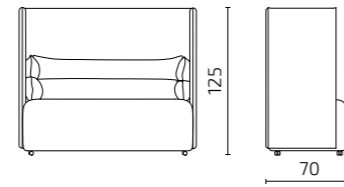
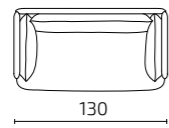

**S129-S25H3**

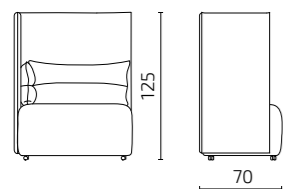
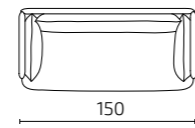

**S129-1CLH3**

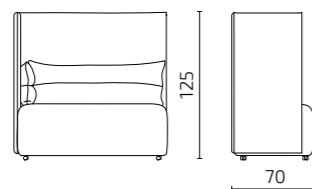
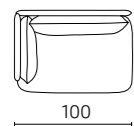

**S129-2CLH3**

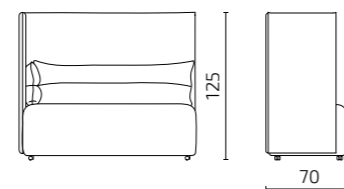
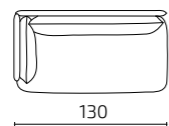

**S129-25CLH3**

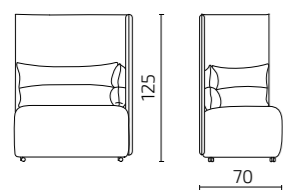
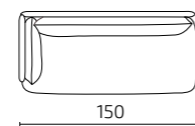

**S129-1CRH3**

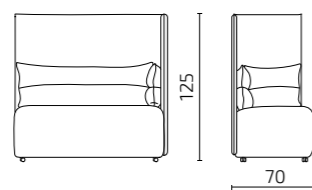
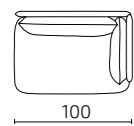

**S129-2CRH3**

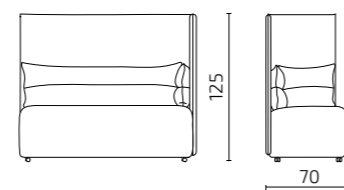
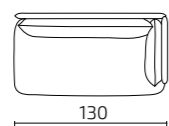

**S129-25CRH3**

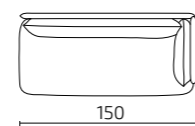

### Tables

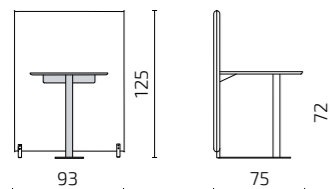

**S129-WH3T1**

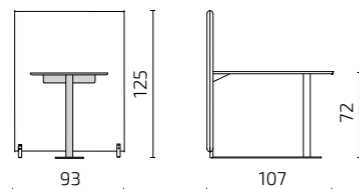
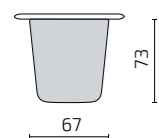

**S129-WH3T2**

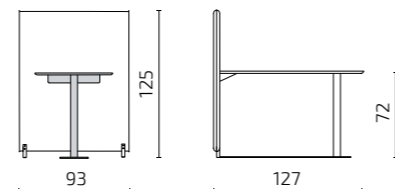
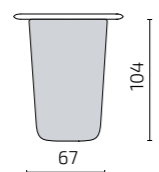

**S129-WH3T25**

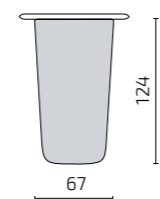

All dimensions provided in centimetres.

## PRICE LIST

Currency: € (VAT excl.)

PRODUCT NAME	CODE	COM/ PWF*	FABRIC CONS.	FABRIC 1	FABRIC 2	FABRIC 3	FABRIC 4	FABRIC 5
WANDER armchair	<b>S129-S1H3</b>	1737	8,3	1812	2068	2346	2718	3090
WANDER sofa 2-Seat	<b>S129-S2H3</b>	2022	8,9	2102	2376	2675	3074	3473
WANDER sofa 2,5-Seat	<b>S129-S25H3</b>	2111	11,8	2217	2581	2977	3506	4035
WANDER left corner module 1-Seat	<b>S129-1CLH3</b>	1596	7,7	1665	1902	2161	2506	2851
WANDER right corner module 1-Seat	<b>S129-1CRH3</b>	1596	7,7	1665	1902	2161	2506	2851
WANDER left corner module 2-Seat	<b>S129-2CLH3</b>	1921	8,3	1995	2251	2530	2902	3274
WANDER right corner module 2-Seat	<b>S129-2CRH3</b>	1921	8,3	1995	2251	2530	2902	3274
WANDER left corner module 2,5-Seat	<b>S129-25CLH3</b>	2005	11,2	2106	2451	2827	3329	3831
WANDER right corner module 2,5-Seat	<b>S129-25CRH3</b>	2005	11,2	2106	2451	2827	3329	3831
WANDER partition wall with table T1 (73x67 cm)	<b>S129-WH3T1</b>	1249	2,5	1271	1348	1432	1544	1656
WANDER partition wall with table T2 (104x67 cm)	<b>S129-WH3T2</b>	1420	2,5	1443	1520	1604	1716	1828
WANDER partition wall with table T25 (124x67 cm)	<b>S129-WH3T25</b>	1492	2,5	1515	1592	1676	1788	1900
<b>Multiple fabrics*</b>								
WANDER armchair	<b>S129-S1H3</b>	1737	8,3	1812	2068	2346	2718	3090
WANDER sofa 2-Seat	<b>S129-S2H3</b>	2022	8,9	2102	2376	2675	3074	3473
WANDER sofa 2,5-Seat	<b>S129-S25H3</b>	2111	11,8	2217	2581	2977	3506	4035
WANDER left corner module 1-Seat	<b>S129-1CLH3</b>	1596	7,7	1665	1902	2161	2506	2851
WANDER right corner module 1-Seat	<b>S129-1CRH3</b>	1596	7,7	1665	1902	2161	2506	2851
WANDER left corner module 2-Seat	<b>S129-2CLH3</b>	1921	8,3	1995	2251	2530	2902	3274
WANDER right corner module 2-Seat	<b>S129-2CRH3</b>	1921	8,3	1995	2251	2530	2902	3274
WANDER left corner module 2,5-Seat	<b>S129-25CLH3</b>	2005	11,2	2106	2451	2827	3329	3831
WANDER right corner module 2,5-Seat	<b>S129-25CRH3</b>	2005	11,2	2106	2451	2827	3329	3831
<b>MODULES WITH ELECTRICAL OUTLET</b>								
WANDER partition wall with table T1 + PC integrated electrical outlet	<b>S129-WH3T1E</b>	1927	2,5	1950	2027	2111	2223	2335
WANDER partition wall with table T2 + PC integrated electrical outlet	<b>S129-WH3T2E</b>	2056	2,5	2078	2155	2239	2351	2463
WANDER partition wall with table T25 + PC integrated electrical outlet	<b>S129-WH3T25E</b>	2104	2,5	2126	2203	2287	2399	2511

\* Customer's Own Material / Price Without Fabric

\*\* Price includes two fabrics from the same price category. For fabrics from different price categories, please contact our sales support for a price calculation.

# Intuit Booth

Available at  

## Phonebooth

Design: Iseasi



You need to make a call. But you'd rather the whole office didn't listen in. Booth provides a quiet oasis, so you can focus on your conversation, without distractions.

We saw an opportunity to make the basic phone booth a much more pleasant place to be. If you've spent time in cramped and claustrophobic phone booths before, you'll marvel at how Booth opens up the space. You can be part of the open-plan space, while still having access to the focus and privacy you need at various points of your day. And its rocking and rotating seat gives you room to move, without banging your elbows on the walls every 5 seconds.

Booth harnesses technology and design to provide an intuitive space for your special task. With sound absorbing upholstery and acoustic panels, Booth dampens noise from every direction. Its motion sensor fresh air ventilation system and adjustable LED lighting help you create exactly the environment you work well in. While its wheels mean you can relocate it to anywhere in your office.

## PRODUCT INFORMATION

### Acoustics

Sound absorption class A

### Movable

On four wheels underneath, floor adjusters are integrated for levelling

### Integrated ventilation

Airflow rate: when occupied 40l/s; stand-by mode, after 5 mins no occupancy 27 l/s

### Accessories

Bar height perch, 360° swivel and rocking

### Electrical outlet

Integrated electrical outlet

### Warranty

5 years

### Sustainability

Based on principles of the circular economy

### Test & Certification

Sound absorption class B



## STANDARD MATERIALS

### Structure

High-quality plywood, painted black

### Outside

Soft upholstered panels covered with any felt fabric

### Inside

Ceiling and wall panels covered with certified acoustic and fire-retardant felt and fabric

### Floor

Carpet tile in a fishbone pattern

### Glass door and back wall

442 laminated and tempered clear glass with sound control PVB interlayer

### Bar height perch

Durable HR-foam, fabric; powder-coated matt metal legs; tilting base

### Fabric upholstery

Choose any felt from **Intuit Standard felt selection**

### Additional information

As part of after-sales service we offer the change of cover fabric and all other components if needed

Utilitas Wind office in Tallinn, Estonia. Photo: Märt Lillesiim



Concentration Zone

Enjoy a room that feels bigger on the inside

Find the peace you need

Take calls without disturbing your team

## INSIDE COVER MATERIALS

### Walls

#### Pressed felt

Dark Grey



Other finishing options available on request.

### Floor

#### Carpet tile

Grey



## ELECTRICAL OUTLET

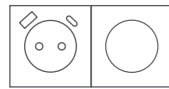

220V + USB A & C + Dimmer



220V + USB A & C + Dimmer

### Jung LS

Color: Anthracite Matt

Available options EU, FR

### Jung LS

Color: Anthracite Matt

Available options UK

### Gira

Color: Anthracite Matt

Available options DK

Other electrical outlet combinations available on request.



## DIMENSIONS

### Phonebooth

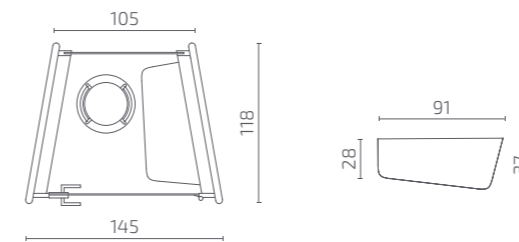
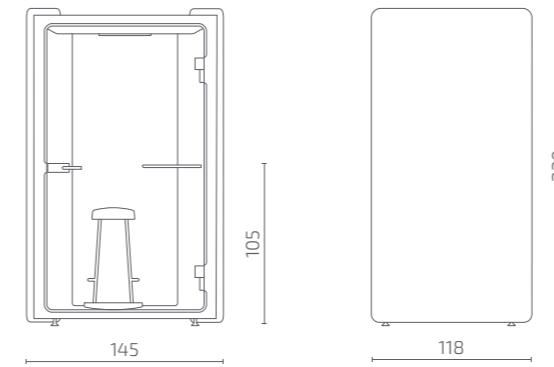

### S122-B00TH1

All dimensions provided in centimetres.

### Bar height perch



### S122-BFL1

### More Space

Booth's trapezoid shape is especially designed to feel spacious. It enables you to choose different positions. Its wide glass panels help you feel part of your wider surroundings, without being disturbed by them. And make the whole booth full of light. You can swing and turn on your chair, adapting your setup to whatever you need to work on.

Utilitas Wind office in Tallinn, Estonia. Photo: Märt Lillesiim



## PRICE LIST

Currency: € (VAT excl.)

PRODUCT NAME	CODE	FABRIC 2
BOOTH phonebooth	S122-B00TH1	11570
BOOTH perch	S122-BFL1	714

# Aide

## Multifunctional table series

Design: Karl Kukkk

The Aide table is an indispensable backdrop, designed to complement room layouts and core furniture. The multi-functional table series comprises variations that are tall, low, slender, sturdy, spacious, compact, and offer a combination of features, totalling 6 different versions.

With its timeless and refined appearance, Aide blends into any interior, while maintaining an understated presence, allowing other furniture pieces to take the spotlight. Aide focuses on function adapting to various environments – it can be a coffee table in the lounge area, a dining table in cafes and canteens, or a desk in the work zone. Finding the perfect solution is easy, as Aide can be integrated with the entire Intuit soft furniture range.



Welcome Zone



Social Zone



Collaboration Zone



Concentration Zone

Easy to combine with other furniture

Can serve several functions

Always blends stylishly into the interior

## PRODUCT INFORMATION

### Versions

Available in 2 different heights and 3 different sizes

### Warranty

5 years

### Sustainability

Based on principles of the circular economy

### Certification



## STANDARD MATERIALS

### Tabletop

Matt high-pressure laminate

### Legs





Powder-coated metal



## FINISHING OPTIONS

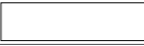



### Tabletop

#### High-pressure laminate

Alpine White Egger W1100 PM	
Soft Black Egger U899 PM	
Stone Green Egger U665 PM	
Garnet Red Egger U399 PM	

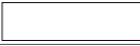

### Legs

#### Powder-coated metal

Signal White RAL 9003	
Jet Black RAL 9005	
Tarpaulin Grey RAL 7010	
Black Red RAL 3007	

## DIMENSIONS

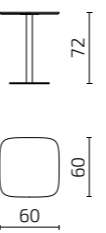
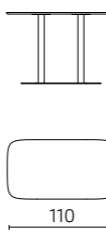
### Cafeteria or work tables

		
<b>S128-T4M</b>	<b>S128-T1M</b>	<b>S128-T3M</b>

### Sofa tables

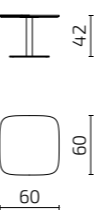
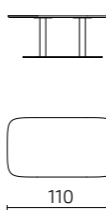
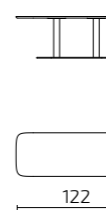
		
<b>S128-T4S</b>	<b>S128-T1S</b>	<b>S128-T3S</b>

All dimensions provided in centimetres.

## PRICE LIST

Currency: € (VAT excl.)

PRODUCT NAME	CODE	PRICE
AIDE cafeteria/work table (60x60x72 cm)	<b>S128-T4M</b>	514
AIDE cafeteria/work table (110x60x72 cm)	<b>S128-T1M</b>	718
AIDE cafeteria/work table (139x60x72 cm)	<b>S128-T3M</b>	728
AIDE sofa table (60x60x42 cm)	<b>S128-T4S</b>	506
AIDE sofa table (110x60x42 cm)	<b>S128-T1S</b>	707
AIDE sofa table (122x44x42 cm)	<b>S128-T3S</b>	707



# Alfred

## Side table

Design: Argo Tamm

Make it easy for your visitors by giving them somewhere to pop their coffee or the piles of notes resting on their lap.

Add its subtle and stylish design to the smaller Social areas you've dotted around the office, and your team can put down their drinks and connect with a quick midday chat.



Welcome Zone



Social Zone



Collaboration Zone

Break up a row of sofas

Make your spaces inviting and practical

## PRODUCT INFORMATION

### Versions

Available in 2 different heights

### Warranty

5 years

### Sustainability

Based on principles of the circular economy

### Certification



## STANDARD MATERIALS

### Tabletop and leg

Solid wood oak

### Base

Powder-coated metal

## FINISHING OPTIONS

### Tabletop and leg

#### Solid oak

Whitened

Natural

Wenge

Black

#### Base

#### Powder-coated metal

Umbr Grey RAL 7022

Jet Black RAL 9005

Other finishing options available on request.

## DIMENSIONS

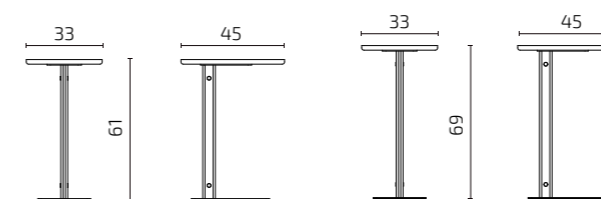

S61-T61T

S61-T69T

All dimensions provided in centimetres.

## PRICE LIST

Currency: € (VAT excl.)

PRODUCT NAME	CODE	PRICE
ALFRED side table (h=61 cm)	S61-T61T	398
ALFRED side table (h=69 cm)	S61-T69T	398
ALFRED side table (h=61 cm) with large base	S61-T61T + A0610-0013	488

# Flow

## Shared office desk

Design: Martin Pärn / Janno Nõu, Iseasi

Sometimes, only a few people come into the office and the room feels empty. Other times, when everyone is there – management, busy bees, guests – it could get a little crowded. With Flow, a shared office desk, neither loneliness nor a lack of space is never an issue

Flow is the social centre of the room, providing an equally welcoming haven for colleagues without a fixed desk as well as for groups holding meetings. The hidden sockets in the table's shelf supports enable one to be productive. It is also an ideal place for team lunches and casual chats. Flow stands without screws on stylish trestles, allowing you to effortlessly give the room a different look with a reversible two-tone tabletop.

## PRODUCT INFORMATION

### Versions

Available in 2 lengths

### Accessories

Shelf  
Under table screen for the wiring

### Electrical outlet

Integrated in the table top (available only for the table with shelf)

### Warranty

5 years

### Sustainability

Based on principles of the circular economy

### Certification



## STANDARD MATERIALS

### Table top

High-pressure laminate or melamine with ABS oak edge band

### Legs

Solid oak

### Metal parts

Powder-coated metal

### Under table screen

Recommended material: any felt fabric from our Standard Fabric Collection

### Additional information

As part of after-sales service we offer the change of cover fabric and all other components if needed



Social Zone



Collaboration Zone

Bring people together

Complements an otherwise empty space

A work and a meeting table



## FINISHING OPTIONS

### Tabletop

#### High-pressure laminate, ABS oak edge band

Garnet Red Egger U399 ST9  
Antique Rose Egger U325 ST9



Indigo Blue Egger U599 ST9  
Cashmere Grey Egger U702 ST9



#### Melamine, ABS oak edge band

Classic White W960 ST7  
Classic Black U999 ST7



Other finishing options available on request.

### Legs

#### Solid oak

Natural



#### Metal parts

##### Powder-coated metal

Jet Black RAL 9005



Grey Blue RAL 5008



Black Red RAL 3007



## DIMENSIONS

### Table without shelf

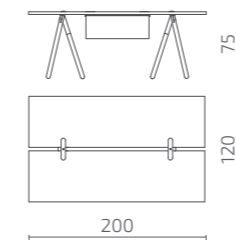

S127-TL200 (laminata)  
S127-TM200 (melamina)

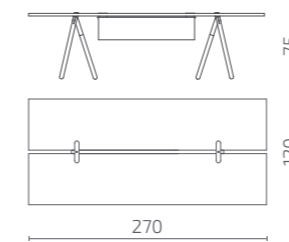

S127-TL270 (laminata)  
S127-TM270 (melamina)

### Table with shelf

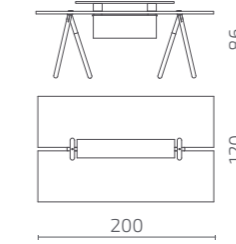

S127-TL200 + S127-TRL (laminata)  
S127-TM200 + S127-TRM (melamina)

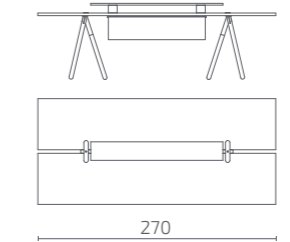

S127-TL270 + S127-TRL (laminata)  
S127-TM270 + S127-TRM (melamina)

All dimensions provided in centimetres.

## ELECTRICAL OUTLET



**Powerdot 16**  
Color: Black Matt

Available options DK, EU, FR

220V + USB A & C



**Powerdot 12**  
Color: Black Matt

Available options UK

220V + USB A + data

Other electrical outlet combinations available on request.



## PRICE LIST

Currency: € (VAT excl.)

PRODUCT NAME	CODE	PRICE
FLOW-200 (laminata)	S127-TL200	2034
FLOW-200 (melamina)	S127-TM200	1425
FLOW-200 with shelf (laminata)	S127-TL200 + S127-TRL	2584
FLOW-200 with shelf (melamina)	S127-TM200 + S127-TRM	1867
FLOW-270 (laminata)	S127-TL270	2367
FLOW-270 (melamina)	S127-TM270	1544
FLOW-270 with shelf (laminata)	S127-TL270 + S127-TRL	2917
FLOW-270 with shelf (melamina)	S127-TM270 + S127-TRM	1986

ELECTRICAL OUTLET	CODE	PRICE
Powerdot 16 220V + USB A & C	S114-EL5	189
Powerdot 12 220V + USB A	S114-EL10	204



# Kuubik

## Sofa table

Design: Argo Tamm

Make it easy. Kuubik is no ordinary table. It's modern cube design means it doesn't impose on its environment.

Use Kuubik to divide up the seating in your reception area, or place them around the office paired with our compact Intro armchair.



Welcome Zone



Social Zone

Bring a little interest to your reception

Encourage inspiring coffee breaks

## PRODUCT INFORMATION

### Versions

Available in 3 different sizes

### Warranty

5 years

### Sustainability

Based on principles of the circular economy

## STANDARD MATERIALS

### Tabletop

Mass-colored wood fibreboard / Veneered MDF board

### Frame

Powder-coated metal

Postimees office in Tallinn, Estonia



## FINISHING OPTIONS

### Tabletop

#### Veneered MDF board

Natural oak



#### Mass-colored wood fibreboard

Black



Other finishing options available on request.

### Frame

#### Powder-coated metal

Jet Black RAL 9005



## DIMENSIONS

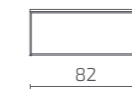
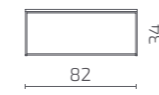
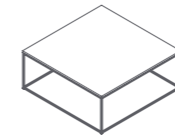

S56-TLK

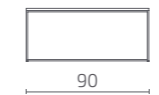
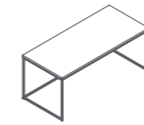

S56-TMA

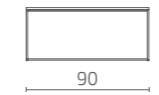
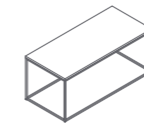

S56-TMK

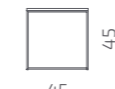

S56-TSA

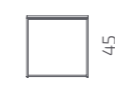

S56-TSK

All dimensions provided in centimetres.

## PRICE LIST

Currency: € (VAT excl.)

PRODUCT NAME	CODE	PRICE
KUUBIK coffee table L	S56-TLK	675
KUUBIK coffee table M with open frame	S56-TMA	451
KUUBIK coffee table M	S56-TMK	451
KUUBIK coffee table S	S56-TSK	328
KUUBIK coffee table S with open frame	S56-TSA	328

# Kuubik

## Side table

Design: Intuit design team

Kuubik side table is a small table of just the right height and weight to pull over your lap while working with the laptop on the couch. The side table is also a comfortable place next to the sofa to place a cup of coffee or a notebook.

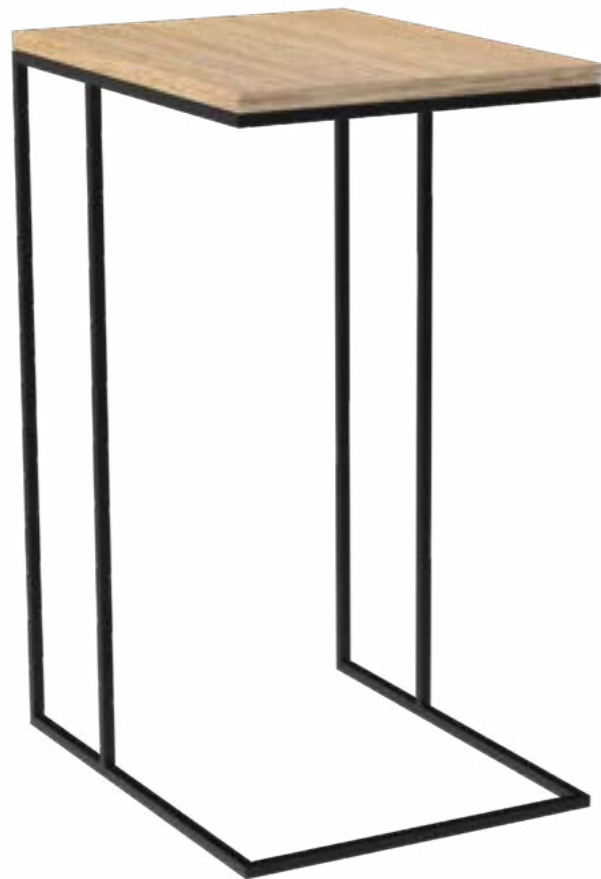

Welcome Zone



Social Zone



Concentration Zone

Give a practical addition to the sofa

Add comfort when working with a laptop on the couch

## PRODUCT INFORMATION

### Versions

Available in 3 different sizes

### Warranty

5 years

### Sustainability

Based on principles of the circular economy

## STANDARD MATERIALS

### Tabletop

Mass-colored wood fibreboard / Veneered MDF board

### Frame

Powder-coated metal

## FINISHING OPTIONS

### Tabletop

#### Veneered MDF board

Natural oak



#### Mass-colored wood fibreboard

Black



Other finishing options available on request.

### Frame

#### Powder-coated metal

Jet Black RAL 9005



## DIMENSIONS

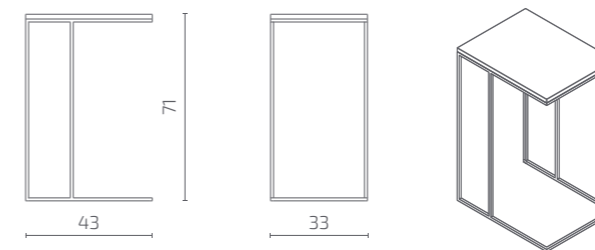

S56-TAB1

All dimensions provided in centimetres.

## PRICE LIST

Currency: € (VAT excl.)

PRODUCT NAME	CODE	PRICE
KUUBIK side table (43x33x71 cm)	S56-TAB1	199

# Rolf

Available at  
**pCon**  
PLANNER

## Mobile table

Design: Iseasi

Keep your conversations agile. A table for flexible collaboration. Designed for ease of movement with its attached wheels and sturdy oak frame, with a height that makes stand-up meetings a breeze. Use these on their own, or push them together to create different configurations. Bar stool height, and always ready for when inspiration strikes, pull over the Rolf and get collaborating.



## PRODUCT INFORMATION

**Warranty**  
5 years

**Legs**  
2 castors, Ø 10 cm

**Sustainability**  
Based on principles of the circular economy

### Certification



## STANDARD MATERIALS

**Tabletop**  
High-pressure laminate with natural oak edge band

**Legs**  
Solid oak

## FINISHING OPTIONS

### Legs

#### Solid oak

Natural



### Tabletop

**High-pressure laminate, natural oak edge band**

Black



White



Other finishing options available on request.

## DIMENSIONS

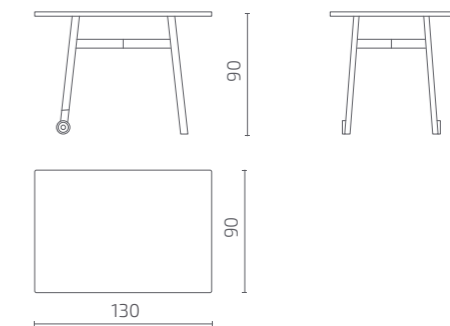

S109-T130

All dimensions provided in centimetres.

## PRICE LIST

Currency: € (VAT excl.)

PRODUCT NAME	CODE	PRICE
ROLF mobile table	S109-T130	2263



Collaboration Zone

Make your office flexible

Encourage active problem-solving

Bring heads together at a moment's notice

Vitronic office in Wiesbaden, Germany  
Photo: Sergey Melnikov

# Grow

Available at  
**pCon**  
 PLANNER

## Mobile plant divider

Design: Lauri Visnapuu

Transform the office into a lush forest and show your commitment to employee well-being. Grow's flowerpots of three different heights act as smart space dividers, offering a secluded retreat from the endlessness of the open office floor plan. Equipped with 360-degree rotating wheels, these planters allow you to refresh the office landscape with a new floral arrangement at your whim.

For added versatility, Grow absorbs office noise and fosters a tranquil environment for the team. Alternatively, choose a multifunctional design featuring a spacious shelf on one side, blending utility with natural beauty.

## PRODUCT INFORMATION

### Versions

Available in 3 different heights

### Acoustics

Sound absorption class D

### Legs

360° rotating and lockable castors

### Warranty

5 years

### Sustainability

Based on principles of the circular economy

### Test & Certification

Acoustic absorption test - Class D



## STANDARD MATERIALS

### Walls

Veneered MDF board, covered with fabric from one or both sides upon request

### Shelving (on models with shelves)

Veneered MDF board

### Legs

Powder-coated metal

### Plant box

Powder coated waterproof steel

### Fabric upholstery

Choose any fabric from **Intuit Standard Fabric Collection**

### Additional information

As part of after-sales service we offer the change of cover fabric and all other components if needed



Welcome Zone



Social Zone



Collaboration Zone



Concentration Zone

Separate work zones and corridors

Create a homey atmosphere

Bring greenery into the office

Improve office acoustics

Construct inspiring private spaces

The top part of Grow features an integrated waterproof metal box for safe watering of plants.

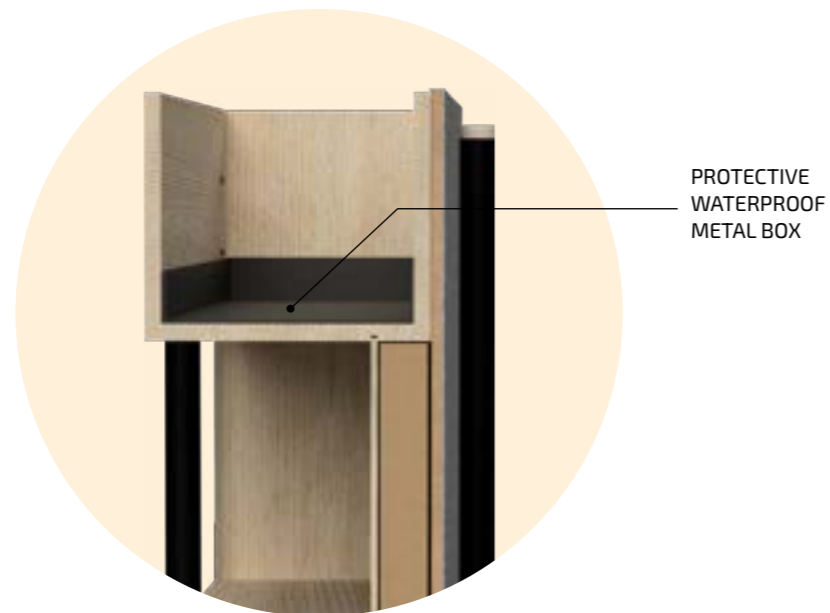

PROTECTIVE WATERPROOF METAL BOX

## FINISHING OPTIONS

### Shelving and walls

#### Veneered MDF board

Natural oak



### Legs

#### Powder-coated metal

Jet Black RAL 9005



Other finishing options available on request.



## DIMENSIONS

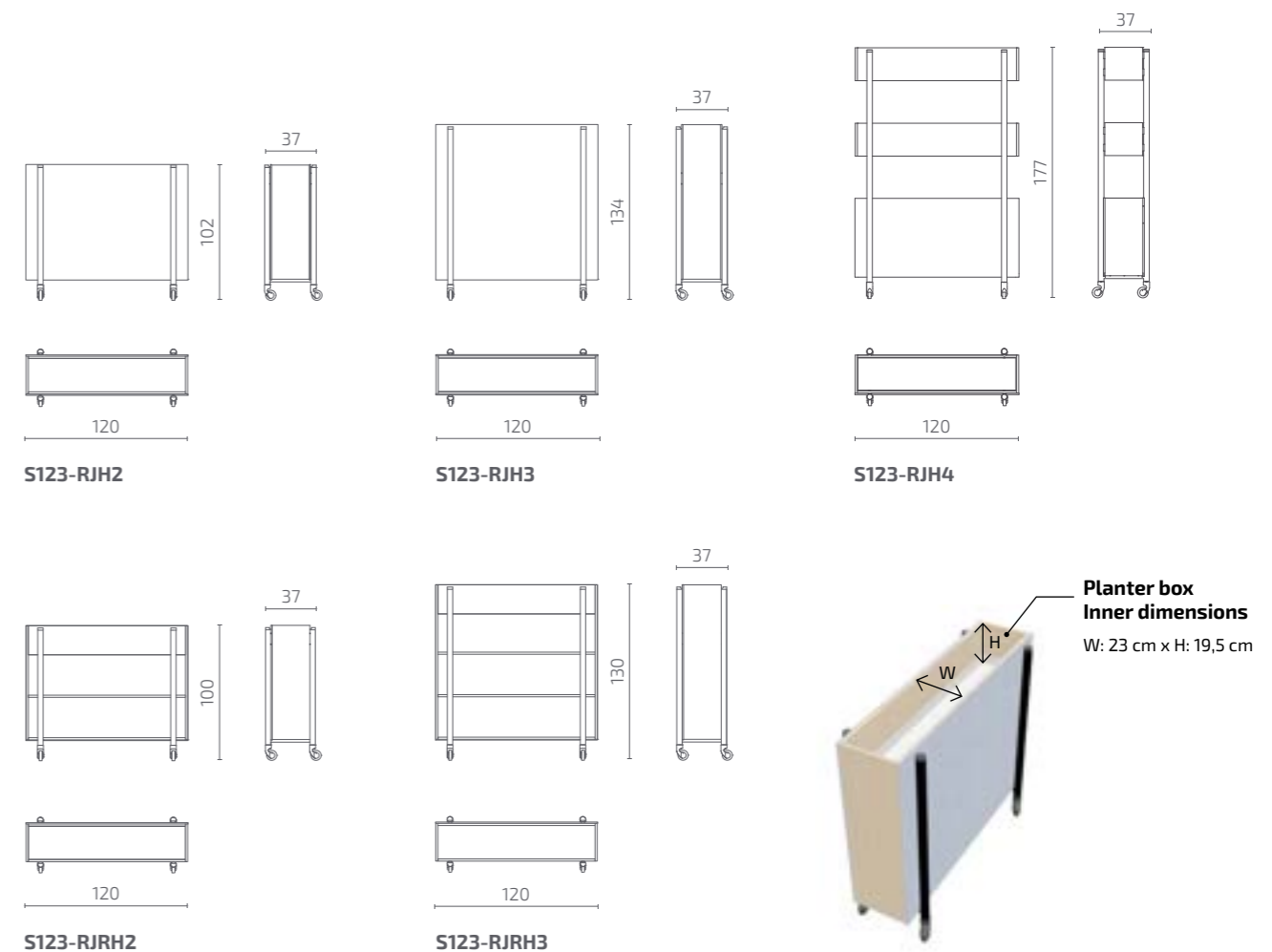

Planter box  
Inner dimensions  
W: 23 cm x H: 19,5 cm

All dimensions provided in centimetres.

## PRICE LIST

Currency: € (VAT excl.)

PRODUCT NAME	CODE	COM / PWF*	FABRIC CONS.	FABRIC 1	FABRIC 2	FABRIC 3	FABRIC 4	FABRIC 5
GROW divider H2	S123-RJH2	1387	2,4	1409	1483	1563	1671	1778
GROW divider with shelf H2	S123-RJRH2	1558	1,2	1568	1605	1646	1700	1753
GROW divider H3	S123-RJH3	1796	3	1823	1916	2016	2151	2285
GROW divider with shelf H3	S123-RJRH3	1930	1,5	1944	1990	2040	2107	2175
GROW divider H4	S123-RJH4	2559	1,6	2574	2623	2677	2748	2820

\* Customer's Own Material / Price Without Fabric

# Hover

## Leaning wall

Design: Karl Kukkk

Sometimes, there's not enough space for a comfortable sofa, but you still want to make waiting comfortable. The day is saved by the soft leaning wall Hover, which you can lean on to pass the time alone or chatting with a companion.

Hover is brilliantly space-saving and fits perfectly in places where you might need to stand, such as at the airport, in a corridor, or behind a meeting room door. Placed in the office kitchen or in an

in-between space, it provides a convenient spot for exchanging ideas with a colleague on the go. Hover is available as a module in four different sizes. By adding a coffee table and a power socket, you can even get work done while leaning. Quickly installable and featuring easily replaceable fabric, Hover also offers noise-dampening properties thanks to its foam and perforated inner panel. Hover is designed for disassembly fully embracing the principles of circular design.



Welcome Zone



Social Zone

Enable to have quick conversations

Save space, adding cosiness to the milieu

Help make waiting more comfortable

## PRODUCT INFORMATION

### Versions

Available in 4 different modules

### Acoustics

Sound absorption class B

### Accessories

Tables to add functionality to the standing area

### Electrical outlet

Integrated electrical outlet

### Warranty

5 years

### Sustainability

Embraces the principles of circular design

### Test & Certification

Acoustic absorption test - Class B



## STANDARD MATERIALS

### Frame

Solid wood slats, perforated MDF-plate

### Mounting

Metal profiles, button-fix

### Backrest

Durable HR foam; fire retardant HR foam on request

### Tables

Mass-colored wood fibreboard top

### Fabric upholstery

The cover fabric is removable

Choose any fabric from **Intuit Standard Fabric Collection**

### Additional information

As part of after-sales service we offer the change of cover fabric and all other components if needed



## CIRCULAR DESIGN

Designed for disassembly fully embracing **the principles of circular design**.

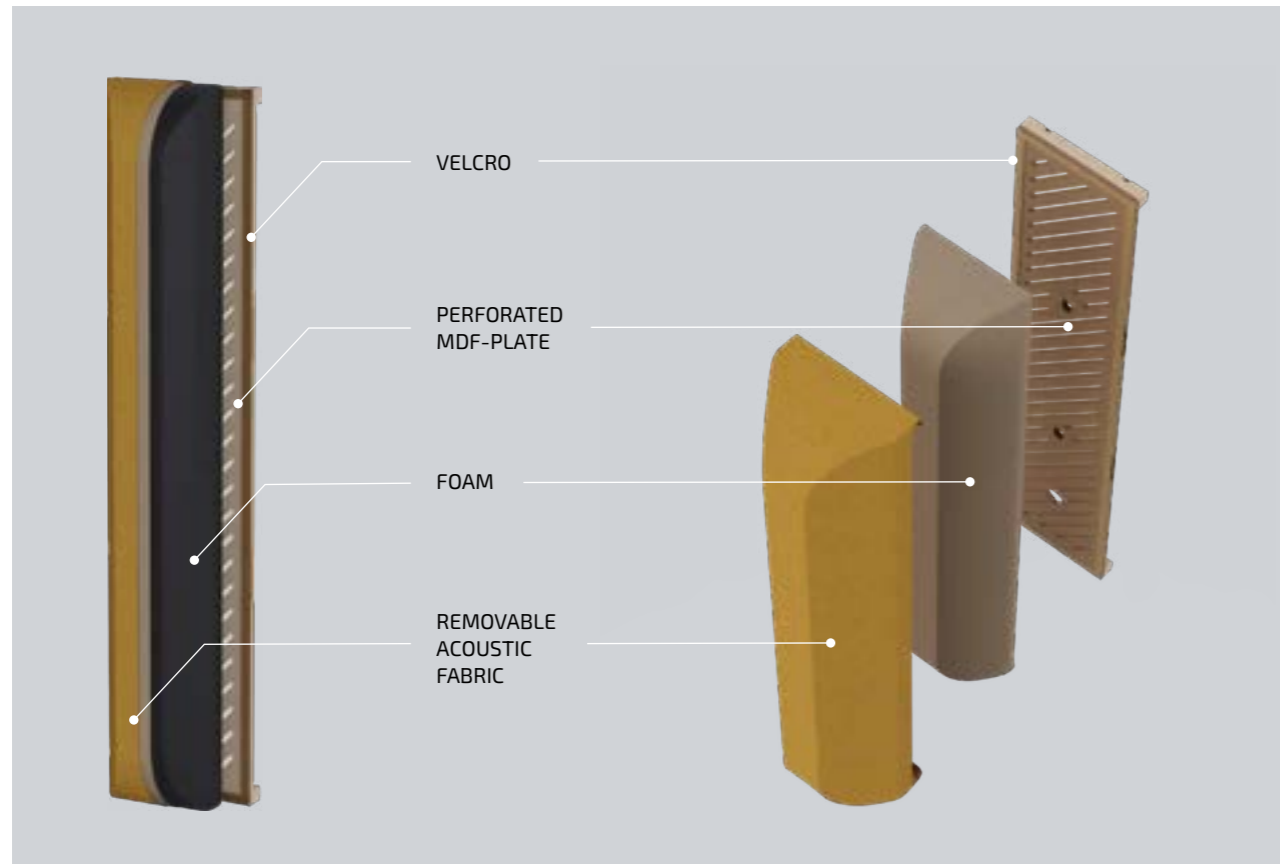

## FINISHING OPTIONS

### Table

**Mass-colored wood fibreboard**

Grey

Black



Other finishing options available on request.



## ELECTRICAL OUTLET



**220V**

**Berker Integro Flow**  
Color: Anthracite Matt

Available options DK, EU, FR, UK



**USB A & C**

**Berker Integro Flow**  
Color: Anthracite Matt

Available options DK, EU, FR, UK

Other electrical outlet combinations available on request.

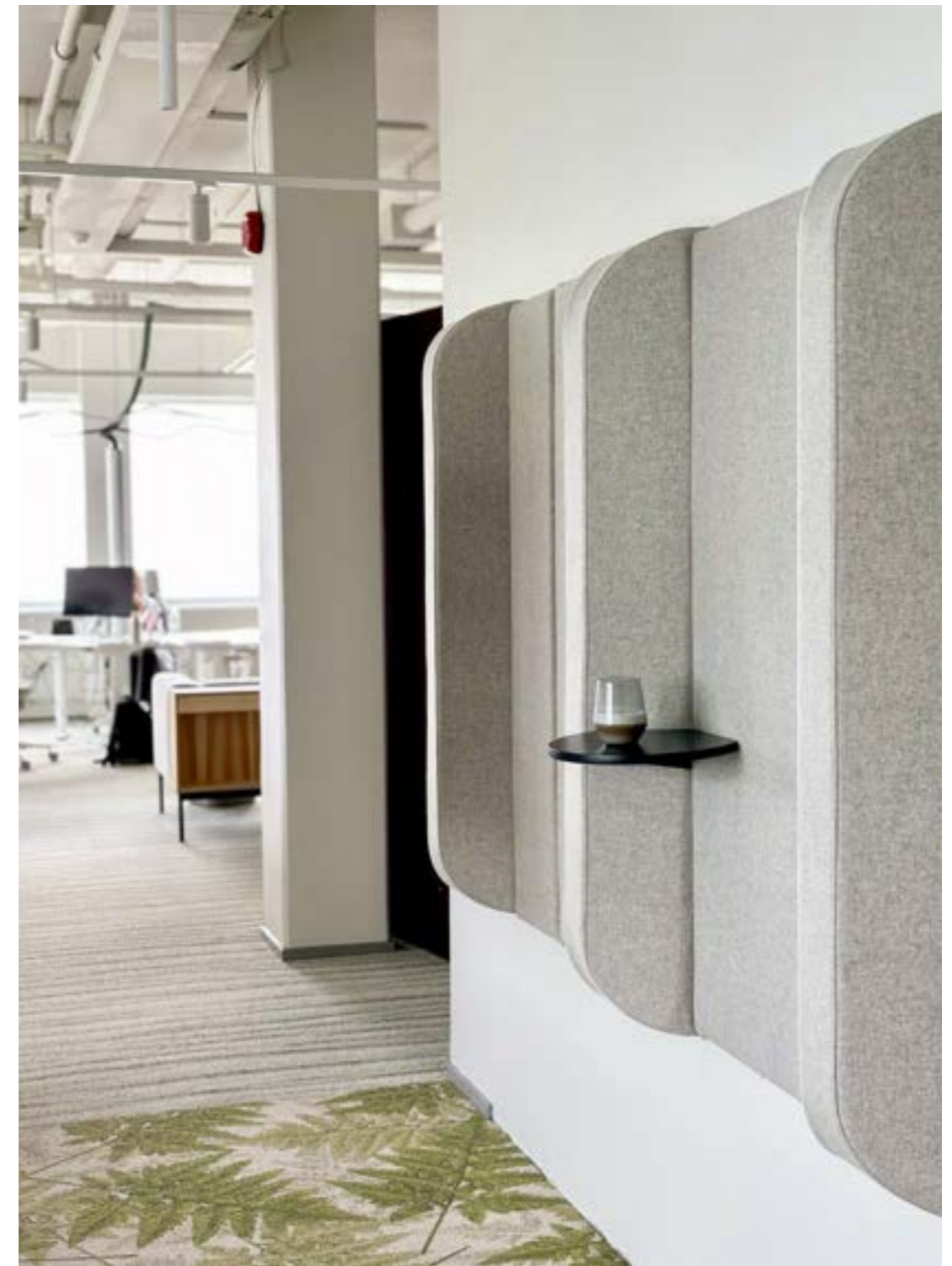

## SAMPLE COMBINATIONS



## DIMENSIONS

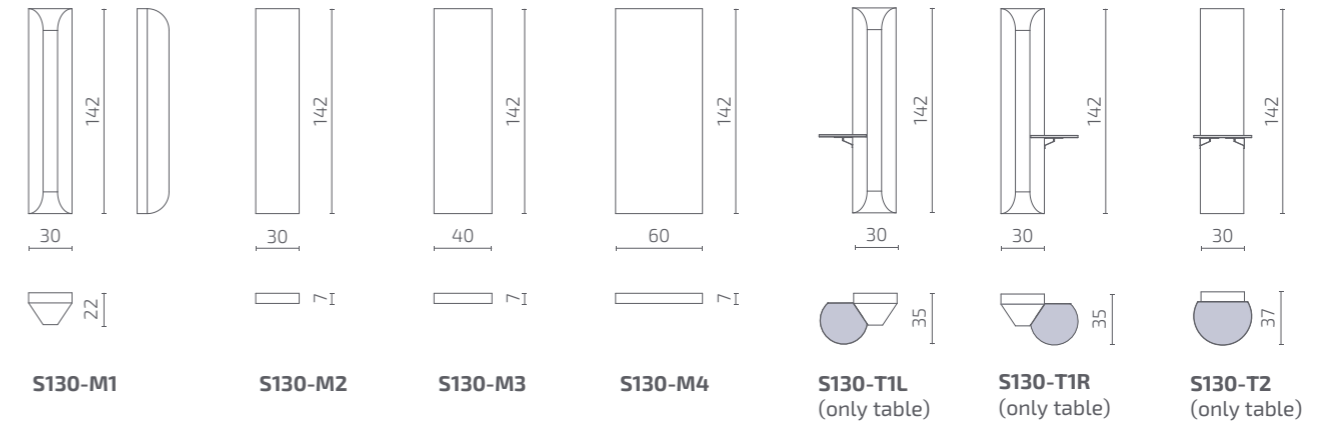

All dimensions provided in centimetres.

## PRICE LIST

Currency: € (VAT excl.)

PRODUCT NAME	CODE	COM / PWF*	FABRIC CONS.	FABRIC 1	FABRIC 2	FABRIC 3	FABRIC 4	FABRIC 5
HOVER corner module	<b>S130-M1</b>	574	2	592	654	721	811	900
HOVER corner module to finish combination (left)	<b>S130-M1L</b>	583	2	601	663	730	820	909
HOVER corner module to finish combination (right)	<b>S130-M1R</b>	583	2	601	663	730	820	909
HOVER module small	<b>S130-M2</b>	426	1,8	442	498	558	639	720
HOVER module medium	<b>S130-M3</b>	435	1,8	451	506	567	647	728
HOVER module large	<b>S130-M4</b>	464	1,8	480	536	596	677	757

TABLES	CODE	PRICE
HOVER side table (left)	<b>S130-T1L</b>	180
HOVER side table (right)	<b>S130-T1R</b>	180
HOVER table	<b>S130-T2</b>	224

MODULES WITH ELECTRICAL OUTLET	CODE	COM / PWF*	FABRIC CONS.	FABRIC 1	FABRIC 2	FABRIC 3	FABRIC 4	FABRIC 5
HOVER module small - Berker Integro Flow 220V	<b>S130-M2E-220V</b>	691	1,8	707	763	823	904	985
HOVER module small - Berker Integro Flow USB A & C	<b>S130-M2E-USB</b>	888	1,8	904	959	1020	1101	1181
HOVER module medium - Berker Integro Flow 220V	<b>S130-M3E-220V</b>	697	1,8	714	769	829	910	991
HOVER module medium - Berker Integro Flow USB A & C	<b>S130-M3E-USB</b>	894	1,8	910	966	1026	1107	1187
HOVER module large - Berker Integro Flow 220V	<b>S130-M4E-220V</b>	727	1,8	743	799	859	940	1021
HOVER module large - Berker Integro Flow USB A & C	<b>S130-M4E-USB</b>	924	1,8	940	995	1056	1137	1217

\* Customer's Own Material / Price Without Fabric

# Note

## Mobile whiteboard

Design: Lauri Visnapuu

Make room for big ideas. Use our convenient mobile whiteboard to utilise every brainstorming opportunity. Equipped with 360-degree wheels, you can take the whiteboard wherever fresh ideas are born.

The back of the whiteboard is optionally covered with cutting-edge acoustic felt. Given its sound-absorbing qualities and notable height, the board can be transformed into a privacy screen, showcasing our love for multifunctional furniture.



Collaboration Zone



Concentration Zone

Minimize workplace noise

Divide your office on the go

Wheel the board around for creative collaboration

## PRODUCT INFORMATION

### Warranty

5 years

### Legs

360° rotating and lockable castors

### Sustainability

Based on principles of the circular economy

### Certification

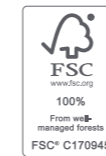

## STANDARD MATERIALS

### Whiteboard

High-pressure decorative laminate

### Panel

MDF, upholstered with batting and covered with acoustic felt on request

### Legs

Powder-coated metal

### Marker Holder

Varnished solid oak

### Fabric upholstery

The cover fabric is not removable

Choose any fabric from **Intuit Standard Fabric Collection**

### Additional information

As part of after-sales service we offer the change of cover fabric and all other components if needed

## DIMENSIONS

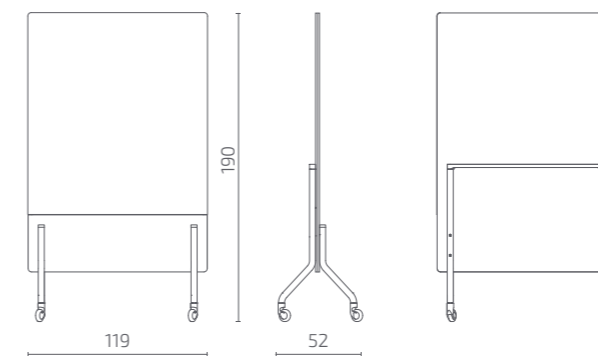

S124-MWH190

All dimensions provided in centimetres.

## FINISHING OPTIONS

### Legs

**Powder-coated metal**

Jet Black RAL 9005

Other finishing options available on request.

## PRICE LIST

Currency: € (VAT excl.)

PRODUCT NAME	CODE	COM/PWF*	FABRIC CONS.	FABRIC 1	FABRIC 2	FABRIC 3	FABRIC 4	FABRIC 5
NOTE whiteboard	S124-MWH190	1676	2,4	1697	1771	1852	1959	2067

\* Customer's Own Material / Price Without Fabric

# Silent Note

## Mobile room divider

Design: Lauri Visnapuu

Shape your world the way you want it. Use this mobile room divider to create a separate space in an open office exactly where you need it. Equipped with 360-degree rotating wheels, it moves easily to the work rhythm of your team.

Silent Note belongs to the Note product family and comes covered with fabric on both sides, offering unlimited possibilities for its unique design. To increase the sound absorbing properties, we recommend using an acoustic felt as a cover.



Collaboration Zone



Concentration Zone

Minimize workplace noise

Divide your office on the go

Wheel the room divider around for creative collaboration

## PRODUCT INFORMATION

### Warranty

5 years

### Legs

360° rotating and lockable castors

### Sustainability

Based on principles of the circular economy

### Certification



## STANDARD MATERIALS

### Panel

MDF, upholstered with batting and covered with acoustic felt on request

### Legs

Powder-coated metal

### Fabric upholstery

The cover fabric is not removable

Choose any fabric from **Intuit Standard Fabric Collection**

### Additional information

As part of after-sales service we offer the change of cover fabric and all other components if needed

## DIMENSIONS

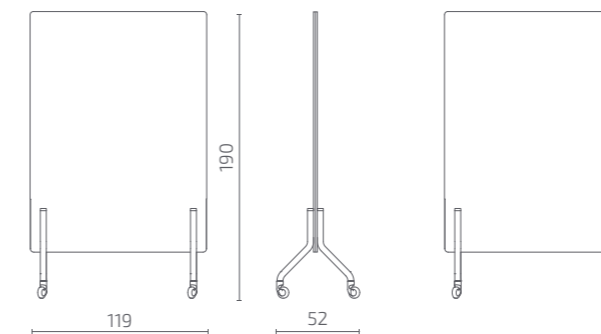

S124-WH190

All dimensions provided in centimetres.

## FINISHING OPTIONS

### Legs

**Powder-coated metal**

Jet Black RAL 9005

Other finishing options available on request.

## PRICE LIST

Currency: € (VAT excl.)

PRODUCT NAME	CODE	COM/PWF*	FABRIC CONS.	FABRIC 1	FABRIC 2	FABRIC 3	FABRIC 4	FABRIC 5
SILENT NOTE divider	S124-WH190	1175	3,45	1206	1312	1428	1583	1737

\* Customer's Own Material / Price Without Fabric

# Oaas

## Planter room divider

Design: Lauri Visnapuu

Character lies in the details. The small, seemingly insignificant elements that give a space its unique identity. The best details don't just enhance aesthetics – they add value!

The Oaas decorative room divider is a stylish and functional backdrop that brightens any room, regardless of size. Its elegant round modules can stand alone or be connected to form 'walls', creating purposeful zones within a space. Designed with practicality in mind, Oaas features a surface perfect for displaying plants or decorative objects. Plus, its fabric-covered outer wall improves acoustics by absorbing echoes.



Welcome Zone



Social Zone



Collaboration Zone



Concentration Zone

Allow the room to be divided into zones

Reduce noise and echoes

Add variety to the room

## PRODUCT INFORMATION

### Versions

Available as a surface or plant pedestal modules in 7 different heights

### Modularity

Modules can be connected together

### Warranty

5 years

### Sustainability

Based on principles of circular economy

### Certification



## STANDARD MATERIALS

### Frame

MDF, carton

### Sole

Felt sole

### Surfaces

Mass-colored wood fibreboard top

### Inside plant pedestals

Water and dirt retardant vinyl fabric, recycled from our production leftovers

### Fabric upholstery

The cover fabric is removable

Choose any felt from **Intuit felt selection**

### Additional information

As part of after-sales service we offer the change of cover fabric and all other components if needed



## FINISHING OPTIONS

### Surface

*Mass-colored wood fibreboard*

Black



Other finishing options available on request.



## SAMPLE COMBINATIONS

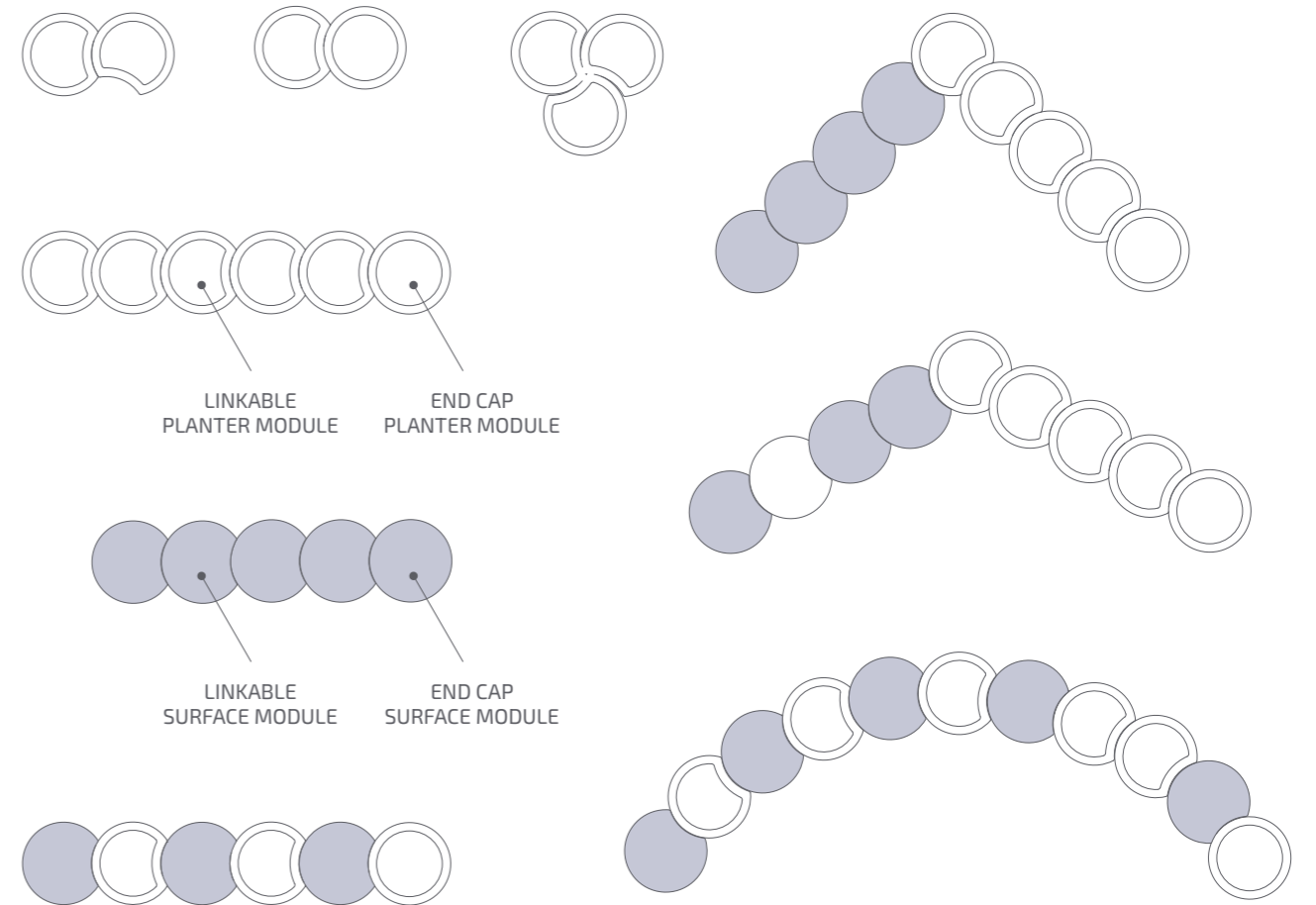

## DIMENSIONS

### Linkable surface module

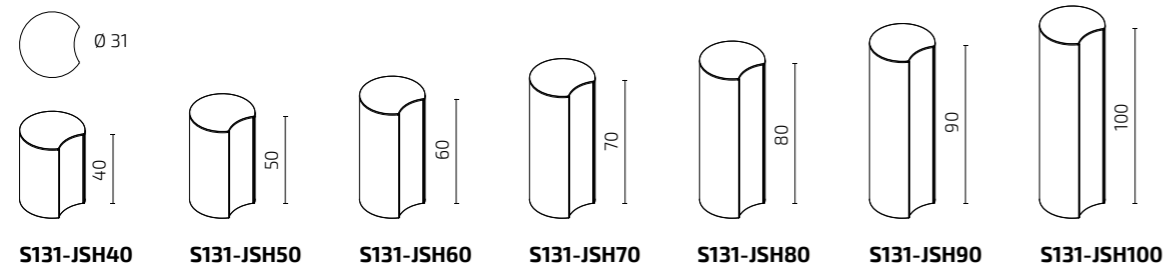

### Linkable planter module

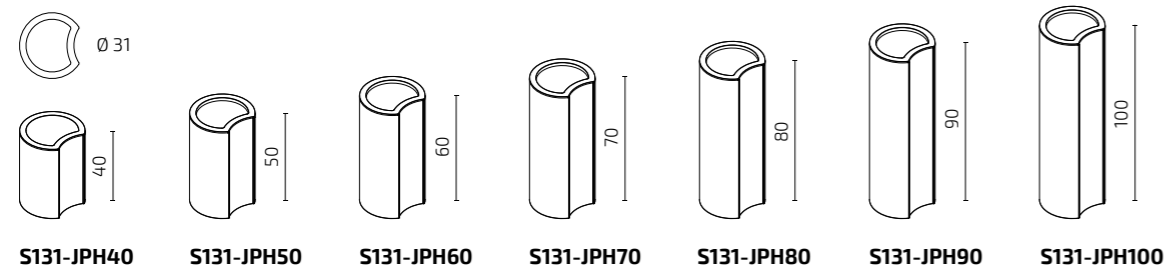

### End cap surface module

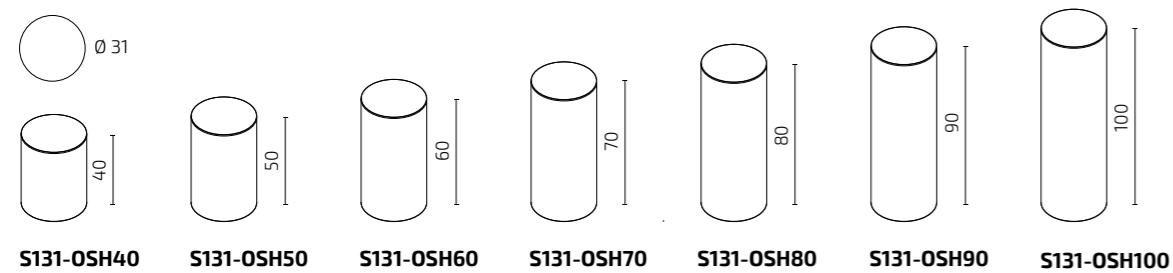

### End cap planter module

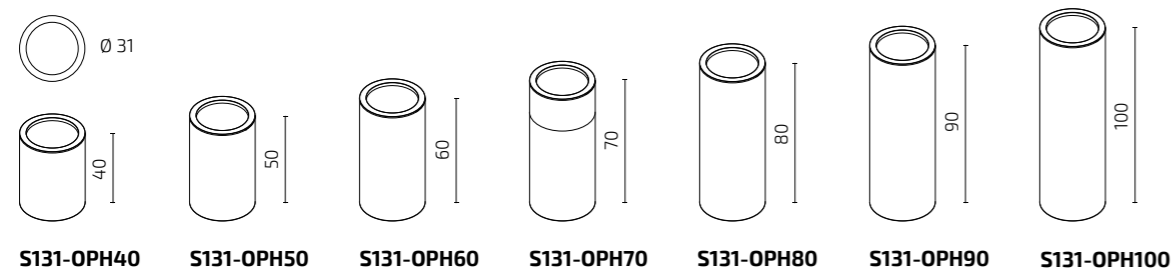

### Planter box inner dimensions

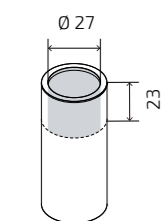

All dimensions provided in centimetres.

## PRICE LIST

Currency: € (VAT excl.)

PRODUCT NAME	CODE	COM/ PWF*	FABRIC CONS.	FABRIC 1	FABRIC 2	FABRIC 3	FABRIC 4	FABRIC 5
<b>Linkable surface module</b>								
OAAS linkable surface module (h=40 cm)	<b>S131-JSH40</b>	228	0,58	234	251	271	297	323
OAAS linkable surface module (h=50 cm)	<b>S131-JSH50</b>	235	0,68	241	262	285	316	346
OAAS linkable surface module (h=60 cm)	<b>S131-JSH60</b>	242	0,78	249	273	299	334	369
OAAS linkable surface module (h=70 cm)	<b>S131-JSH70</b>	249	0,88	257	284	313	353	392
OAAS linkable surface module (h=80 cm)	<b>S131-JSH80</b>	255	0,98	264	294	327	371	415
OAAS linkable surface module (h=90 cm)	<b>S131-JSH90</b>	262	1,08	272	305	342	390	438
OAAS linkable surface module (h=100 cm)	<b>S131-JSH100</b>	268	1,18	279	315	355	408	461
<b>Linkable planter module</b>								
OAAS linkable planter module (h=40 cm)	<b>S131-JPH40</b>	243	0,58	248	266	286	312	338
OAAS linkable planter module (h=50 cm)	<b>S131-JPH50</b>	253	0,68	260	281	303	334	364
OAAS linkable planter module (h=60 cm)	<b>S131-JPH60</b>	260	0,78	267	291	318	352	387
OAAS linkable planter module (h=70 cm)	<b>S131-JPH70</b>	267	0,88	275	302	332	371	410
OAAS linkable planter module (h=80 cm)	<b>S131-JPH80</b>	274	0,98	283	313	346	390	434
OAAS linkable planter module (h=90 cm)	<b>S131-JPH90</b>	281	1,08	290	324	360	408	457
OAAS linkable planter module (h=100 cm)	<b>S131-JPH100</b>	287	1,18	298	334	374	427	480
<b>End cap surface module</b>								
OAAS end cap surface module (h=40 cm)	<b>S131-OSH40</b>	212	0,58	217	235	254	280	306
OAAS end cap surface module (h=50 cm)	<b>S131-OSH50</b>	214	0,68	220	241	264	295	325
OAAS end cap surface module (h=60 cm)	<b>S131-OSH60</b>	224	0,78	231	255	281	316	351
OAAS end cap surface module (h=70 cm)	<b>S131-OSH70</b>	230	0,88	238	265	294	334	373
OAAS end cap surface module (h=80 cm)	<b>S131-OSH80</b>	236	0,98	244	275	308	351	395
OAAS end cap surface module (h=90 cm)	<b>S131-OSH90</b>	242	1,08	251	285	321	369	418
OAAS end cap surface module (h=100 cm)	<b>S131-OSH100</b>	247	1,18	258	294	334	387	440
<b>End cap planter module</b>								
OAAS end cap planter module (h=40 cm)	<b>S131-OPH40</b>	229	0,58	234	252	271	297	323
OAAS end cap planter module (h=50 cm)	<b>S131-OPH50</b>	235	0,68	241	262	285	315	346
OAAS end cap planter module (h=60 cm)	<b>S131-OPH60</b>	241	0,78	248	272	298	333	368
OAAS end cap planter module (h=70 cm)	<b>S131-OPH70</b>	247	0,88	255	282	311	351	390
OAAS end cap planter module (h=80 cm)	<b>S131-OPH80</b>	253	0,98	261	292	324	368	412
OAAS end cap planter module (h=90 cm)	<b>S131-OPH90</b>	258	1,08	268	301	338	386	434
OAAS end cap planter module (h=100 cm)	<b>S131-OPH100</b>	264	1,18	275	311	351	404	457

\* Customer's Own Material / Price Without Fabric

# Sigmund

Available at  
**pCon**  
 PLANNER

## Sound-absorbing screen

Design: Pent Talvet, Iseasi

The office of the future is agile and flexible. When you need to change the use of a space without knocking down walls, then you need Sigmund. This ingenious sound-absorbing screen can make any area feel like a private office.

Create a smaller Collaboration Zone within an open-plan space, or curate an enclosed seating area. Wherever the flow of your workplace, Sigmund can help you intuitively meet the needs of your team. Without having to don a hard hat.



## PRODUCT INFORMATION

**Warranty**  
5 years

**Legs**  
360° rotating wheels

**Sustainability**  
Based on principles of the circular economy

### Certification



## STANDARD MATERIALS

**Filling**  
Synthetic felt with sound-absorbing qualities; cotton batting; HR-foam

**Fabric upholstery**  
The cover fabric is not removable  
Choose any fabric from **Intuit Standard Fabric Collection**

**Additional information**  
As part of after-sales service we offer the change of cover fabric and all other components if needed

## DIMENSIONS

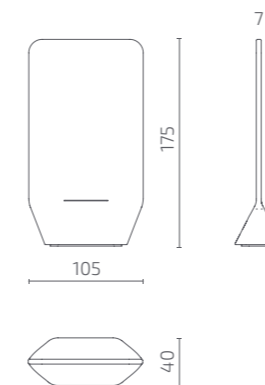

S104-WH175

All dimensions provided in centimetres.



Social Zone



Collaboration Zone



Concentration Zone

Easily display information

Deal with background noise

Create a quiet corner

Divide your open space

## PRICE LIST

Currency: € (VAT excl.)

PRODUCT NAME	CODE	COM/PWF*	FABRIC CONS.	FABRIC 1	FABRIC 2	FABRIC 3	FABRIC 4	FABRIC 5
SIGMUND screen	S104-WH175	796	3,8	830	947	1075	1245	1415

\* Customer's Own Material / Price Without Fabric

# Sprout

## Mobile plant divider

Design: Lauri Visnapuu

Adding greenery to a space enhances overall wellbeing and helps boost productivity. Use the practical Sprout space divider, which lets you grow suitable plants right inside it.

Sprout is ideal for making any space more visually appealing and cosy. Use it to define work areas or leave it in communal spaces for flexible use – Sprout's wheels make it easy to move it around. Sprout is precisely sized to fit between two opposite-facing desks, covering the full span of both workstations and providing privacy. It comes in two heights with three different top surfaces. The fabric-covered exterior adds character and improves room acoustics.



Welcome Zone



Social Zone



Collaboration Zone



Concentration Zone

Easy to move and reposition as needed

Divide the room into zones

Add greenery, cosiness, and a sense of privacy

## PRODUCT INFORMATION

### Versions

Available with 3 different surface widths and in 2 different heights

### Legs

360° rotating and lockable castors

### Warranty

5 years

### Sustainability

Based on principles of circular economy

### Certification



## STANDARD MATERIALS

### Frame

Sheet metal, plywood

### Surfaces

Mass-colored wood fibreboard top

### Planter box

Powder coated waterproof sheet metal

### Fabric upholstery

Choose any felt from **Intuit felt selection**

### Additional information

As part of after-sales service we offer the change of cover fabric and all other components if needed



## FINISHING OPTIONS

### Surface

**Mass-colored wood fibreboard**

Black



Other finishing options available on request.



**Plants** make people happy

## DIFFERENT SURFACES

### NARROW SURFACE

The most compact option. With minimal surface space around the planting area, this version is perfect for use in narrow corridors and passageways.

### EXTENDED SURFACE

The medium-width surface surrounding the planting area is complemented by an extra surface. It can be used for seating or storing work equipment. Suitable for both open areas and between desks.

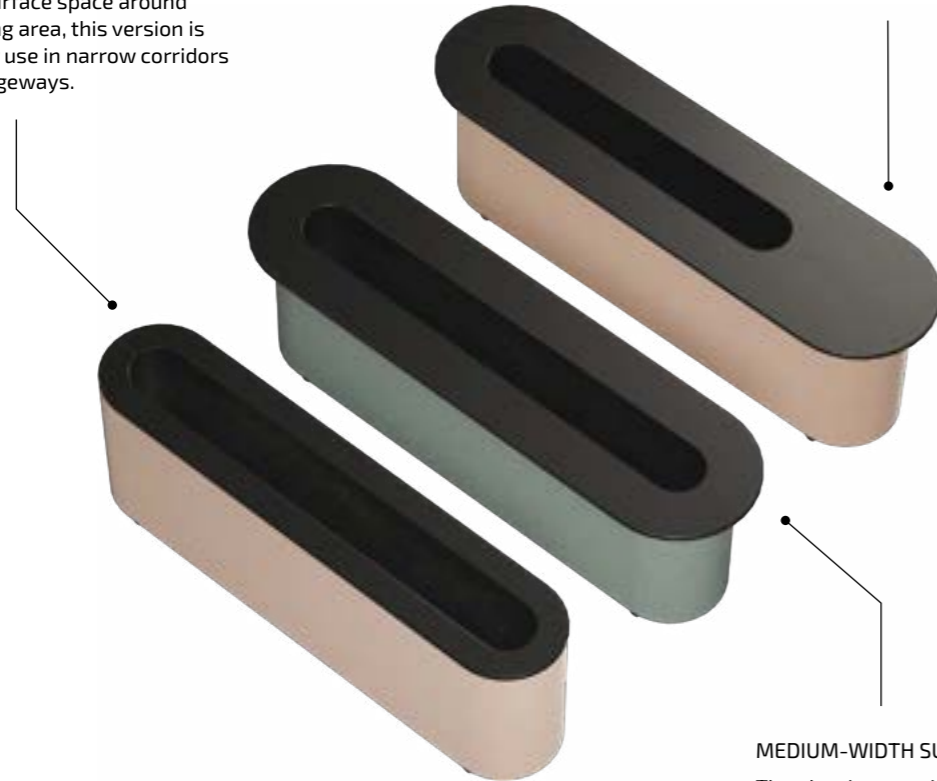

### MEDIUM-WIDTH SURFACE

The planting area is bordered by a medium-width surface – ideal for resting small items like a coffee cup. Suitable for placement in the centre of a room, where it creates visual separation.



## DIMENSIONS

### Narrow surface

#### Planter box inner dimensions

Width: 150 cm / Depth: 31 cm / Height: 22 cm

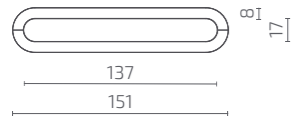
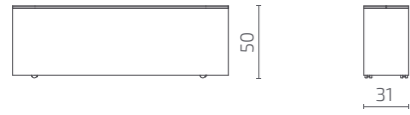

**S78-V1H1**

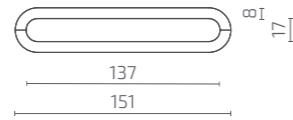
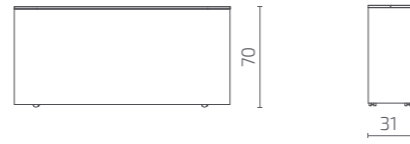

**S78-V1H2**

### Medium-width surface

#### Planter box inner dimensions

Width: 150 cm / Depth: 31 cm / Height: 22 cm

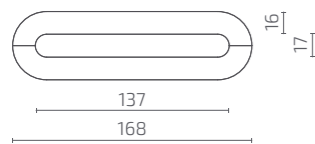
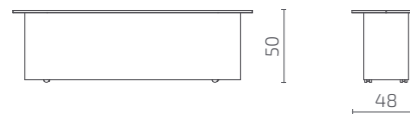

**S78-V2H1**

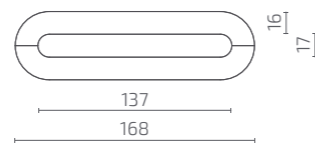
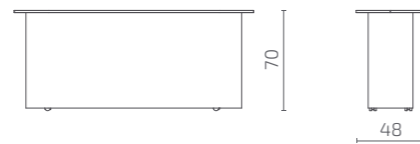

**S78-V2H2**

### Extended surface

#### Planter box inner dimensions

Width: 150 cm / Depth: 31 cm / Height: 22 cm

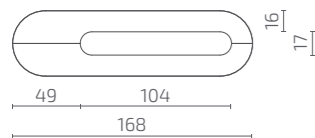
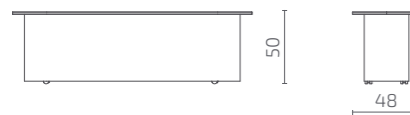

**S78-V3H1**

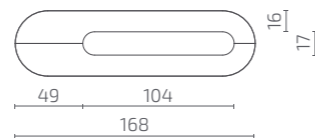
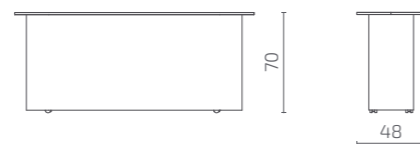

**S78-V3H2**

All dimensions provided in centimetres.

## PRICE LIST

Currency: € (VAT excl.)

PRODUCT NAME	CODE	COM / PWF*	FABRIC CONS.	FABRIC 1	FABRIC 2	FABRIC 3	FABRIC 4	FABRIC 5
SPROUT narrow surface H1	<b>S78-V1H1</b>	1396	1,8	1380	1400	1422	1450	1479
SPROUT narrow surface H2	<b>S78-V1H2</b>	1435	3,6	1403	1442	1485	1543	1601
SPROUT medium-width surface H1	<b>S78-V2H1</b>	1564	1,8	1548	1567	1589	1618	1647
SPROUT medium-width surface H2	<b>S78-V2H2</b>	1603	3,6	1570	1610	1653	1711	1768
SPROUT extended surface H1	<b>S78-V3H1</b>	1571	1,8	1555	1575	1596	1625	1654
SPROUT extended surface H2	<b>S78-V3H2</b>	1610	3,6	1577	1617	1660	1718	1775

\* Customer's Own Material / Price Without Fabric



Narrow surface



Medium-width surface



Extended surface

## STANDARD FABRIC COLLECTION: A SYMPHONY OF DESIGN, DURABILITY AND SUSTAINABILITY

At Intuit by Softrend, we understand that the right fabric can transform a piece of furniture from merely functional to truly exceptional. That's why we offer an extensive Standard Fabric Collection, featuring over 1,000 high-quality fabrics sourced from renowned international suppliers including Camira, Kvadrat, Gabriel, and others. Each fabric is carefully selected to ensure it meets the rigorous demands of public spaces, with superior durability and compliance with flame and/or fire resistance standards.

Our collection is meticulously curated to cater to diverse tastes and budgets, organized into five distinct price categories. This structured assortment ensures that whether you're seeking luxury or affordability, you'll find fabrics that do not compromise on quality or style.

For those who desire a personal touch, we offer the flexibility to upholster your chosen furniture with your own material, allowing for a truly customized interior experience.

We are committed to sustainability; the majority of our fabrics bear the Oeko-Tex or Ecolabel certifications and/or are made from recycled materials, reflecting our dedication to environmental responsibility. Our annual update of the fabric selection not only aligns with the latest trends but also retains beloved classics that have stood the test of time.

Discover fabrics ranging from rich wools and sleek artificial leathers to soft felts, most backed by a 10-year manufacturer's warranty. The Intuit by Softrend Standard Fabric Collection is designed not just to meet, but to exceed the functional and aesthetic needs of any space.



# STANDARD FABRICS SELECTION 2026

## PRICE CATEGORY 1

Brand	Design	Martindale	Composition	Flammability standard				Sustainability	Other
				EN 1021 1 & 2	BS 5852		IMO		
					Part 1 0 & 1	Part 2 5 Crib			
Camira	<a href="#">Era CSE</a> 01, 02, 21, 25, 31, 32, 34, 39, 41, 42	100 000	100% polyester	X		X			10 YEAR
Davis	<a href="#">Cloud</a>	90 000	100% polyester	Part 1 only	X				
Davis	<a href="#">Storm</a>	100 000	100% polyester	Part 1 only	X				
Nevotex	<a href="#">Lido/Lido Trend</a>	115 000	100% polyester	Part 1 only	X				
Textum	<a href="#">Lotos</a>	100 000	80% PES 20% CO base fabric 100% PU surface		X				



## PRICE CATEGORY 2

Brand	Design	Martindale	Composition	Flammability standard				Sustainability	Other
				EN 1021 1 & 2	BS 5852		IMO		
					Part 1 0 & 1	Part 2 5 Crib			
Blue Company	<a href="#">Dama</a>	> 60 000	70% wool 20% polyester 5% polyamide 5% acrylic (recycled wool)	X	X	X			
Camira	<a href="#">Era*</a>	100 000	100% polyester	X		X			10 YEAR
Camira	<a href="#">Vita</a>	100 000	Surface: 98% PVC 2% PU Substrate: 100% cotton	X		X	On request		
Camira	<a href="#">RePlay</a>	100 000	100% post-consumer recycled polyester	X		X		  	10 YEAR
Camira	<a href="#">X2</a>	100 000	100% recycled polyester	X		X		  	10 YEAR
Fabraa	<a href="#">Facet</a>	100 000	70% recycled wool 25% polyamide 5% blended fibre	X	X				
Fabraa	<a href="#">Forward</a>	100 000	50% recycled wool 30% linen 20% recycled polyamide	X	X				
Gabriel	<a href="#">Cura</a>	100 000	98% post-consumer recycled polyester 2% polyester	X	X			  	10 YEAR
Kvadrat	<a href="#">Autumn</a>	50 000	100% recycled polyester	X	X	X		 	10 YEAR
Kvadrat	<a href="#">Guest</a>	100 000	100% recycled polyester	X	X	X		 	10 YEAR
Nevotex	<a href="#">Wooly</a>	150 000	70% recycled wool 25% polyamide 5% blended fibre	X	X				
Textafoam	<a href="#">Aston</a>	70 000	100% polyester		X				

\* Except the fabric tones listed in Price category 1

PRICE CATEGORY 3

Brand	Design	Martindale	Composition	Flammability standard				Sustainability	Other
				EN 1021 1 & 2	BS 5852		IMO		
					Part 1 0 & 1	Part 2 5 Crib			
AquaClean	<a href="#">Altamura</a>	80 000	81% polyester 12% macintosh 6% cotton 1% nylon	X					
AquaClean	<a href="#">Daytona</a>	200 000	51% polyester 38% acrylic 11% polyamide	X	X				
Camira	<a href="#">Main Line Flax</a>	50 000	70% virgin wool 30% flax	X		X	On request		10 YEAR
Camira	<a href="#">Main Line Twist</a>	50 000	75% virgin wool 30% flax	X		X			10 YEAR
Camira	<a href="#">Oceanic</a>	100 000	100% post-consumer recycled polyester excl. 50% SEAQUAL® YARN	X		X			10 YEAR
Camira	<a href="#">Sumi</a>	200 000	90% wool 10% polyamide	X		X	On request		10 YEAR
Gabriel	<a href="#">Step Melange</a>	100 000	100% Trevira CS	X	X	X			10 YEAR
Kvadrat	<a href="#">Remix 3</a>	100 000	90% new wool worsted 10% nylon		X	X			10 YEAR
Spradling	<a href="#">Silvertex</a>	300 000	100% vinyl topcoat 100% polyester backing	X					

PRICE CATEGORY 4

Brand	Design	Martindale	Composition	Flammability standard				Sustainability	Other
				EN 1021 1 & 2	BS 5852		IMO		
					Part 1 0 & 1	Part 2 5 Crib			
Camira	<a href="#">Kyoto</a>	200 000	90% wool 10% polyamide	X		X	On request		10 YEAR
Camira	<a href="#">Synergy</a>	100 000	95% virgin wool 10% polyamide	X		X	On request		10 YEAR
Gabriel	<a href="#">Fame</a>	200 000	95% New Zealand wool 5% polyamide	X		X			10 YEAR
Kvadrat	<a href="#">Re-wool 2</a>	100 000	45% recycled wool 45% new wool 10% nylon	X	X	X			10 YEAR

PRICE CATEGORY 5

Brand	Design	Martindale	Composition	Flammability standard				Sustainability	Other
				EN 1021 1 & 2	BS 5852		IMO		
					Part 1 0 & 1	Part 2 5 Crib			
Camira	<a href="#">Blazer</a>	45 000	100% virgin wool	X		X	On request		10 YEAR
Camira	<a href="#">Yoredale</a>	50 000	95% wool 3% polyester 2% polyamide	X		X	On request		10 YEAR
Kvadrat	<a href="#">Canvas 2</a>	100 000	90% new wool worsted 10% nylon	X	X	X			10 YEAR
Kvadrat	<a href="#">Steelcut Trio 3</a>	100 000	90% new wool 10% nylon	X	X				10 YEAR





**intuit**  
BY SOFTREND

**Are You Intuit?**

 [intuitoffice.com](https://intuitoffice.com)

 [intuit\\_office](https://www.instagram.com/intuit_office)

 [Intuit by Softrend](https://www.facebook.com/IntuitbySoftrend)

 [Intuit by Softrend](https://www.linkedin.com/company/intuitbysoftrend)

Browse the Collection

